

LEGGO ANCH'IO

Prima parte

*Emidio Tribulato
Isabella Ialacqua
Rosaria Visalli*

CA



Fun

CENTRO STUDI LOGOS
ONLUS
CENTRO DI RICERCHE PSICOPEDAGOGICHE
VIA PRINCIPE TOMMASO 2 - MESSINA
TEL. 090/46920
DIRETTORE: DOTT. EMIDIO TRIBULATO

“LEGGO ANCH'IO”

LETTURA SILLABICA FACILITATA

Prima Parte

Emidio Tribulato
Isabella Falaequa
Rosaria visalli

 2009 - Tutti i diritti riservati.

E - mail: postmaster@cslogos.it --- Nuovo sito web: www.cslogos.it

Vol. IV

Gl gi *gi* *Gi*

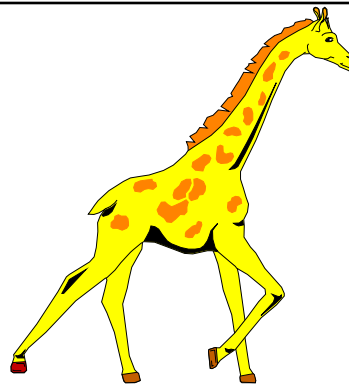

GIRAFFA

giraffa

giraffa

Gi raffa

Gl gi *gi* *Gi*



GIACCA

giacca

giacca

Giacca

Gl gi *gi* *Gi*



GIOSTRA

giostrotta

giostrotta

3

Giostrotta

Cerca le **GI**

GI FI GA FI GI GE GI
GU GI GO VI ZI GI MI
GE VI GE MI GI GA GI

Cerca le **gi**

gi ge gi pi gi gu gi vi
ge gi fi gi go gi li gu
gi gu li gi fi ga ci gi

Cerca le *gi*

gi mi ga gi ge ga gi mi

gi ri gi bi go gi ga gi

ge bi gi li gi ge li gi

Cerca le *Gi*

Pa Gi Li Pi Vi Gi Ji Gi

Gi Go Gi Gi Ji Gi Vi Gi

Vi Go Gi Ni Ji Li Gi Ki

Leggi

GI

Gi

GI

Gi

GI

ig

ig

ig

Ig

ig

Gi

gi

gi

gi

gi

ig

Ig

ig

IG

ig

A GI

e gi

E GI

I GI

O GI

u gi

a gi

i gi

e gi

i gi

o gi

u gi

O GI

A GI

e gi

i gi

O gi

u gi

u gi

a gi

Leggi

La giraffa

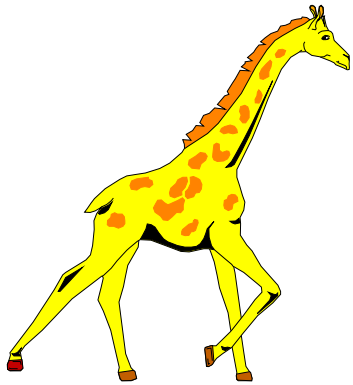

Il giudice



La giacca



Il saggio

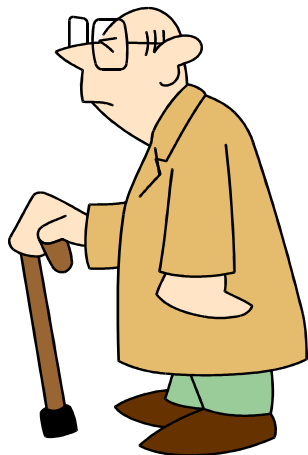

I raggi

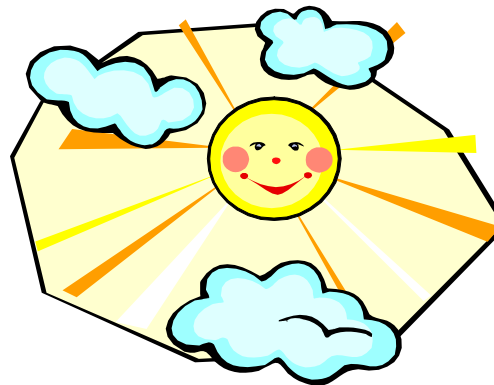

La reggia

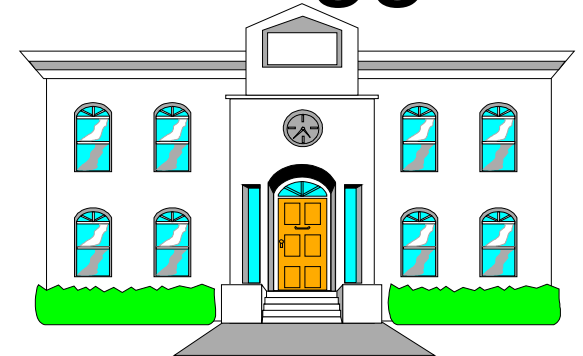

Leggi

I giocattoli



Il vigile



Il giubbotto



Il pugile



È giallo

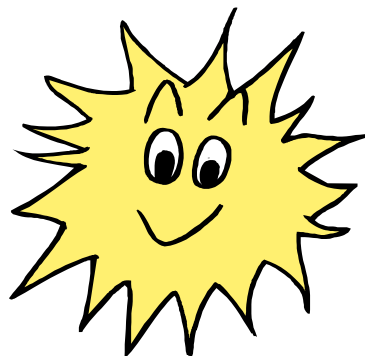

La giara



Leggi

Gigi cuoce i fagioli!



La giraffa è alta

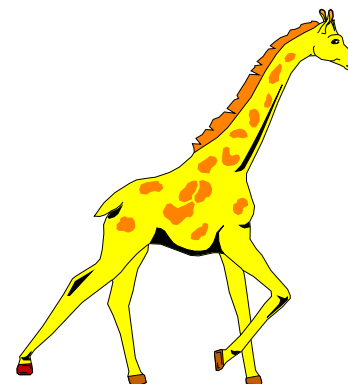

La valigia è aperta



Luigi gioca a palla



Leggi e associa

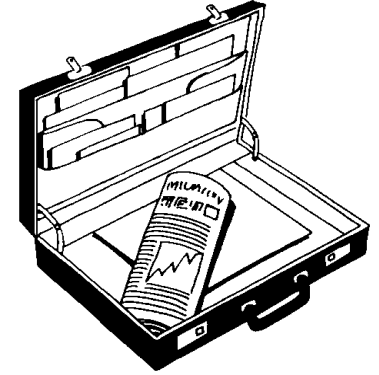
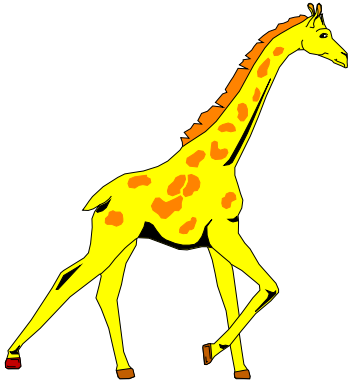

I giocattoli

La giraffa

La valigia

La giacca

Leggi

Gi Ge

gi ga

Gi Ge

Gi ga

GI DU

gi do

du gi

Di gi

De gi

GI DA

Bu gi

gi bo

O gi

E GE

O gi

O ga

I DU

u gi

O do

u di

o gi

a gi

a gi

i de

O gi

a da

i BU

GI come ...
gi come...

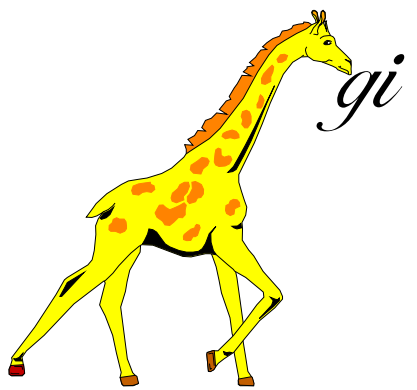

come ...



GI come ...

gi come ...

gi come ...

GE come ...

ge come ...

ge come ...

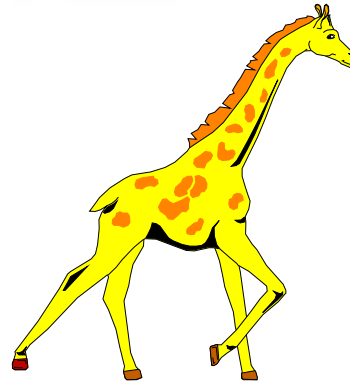
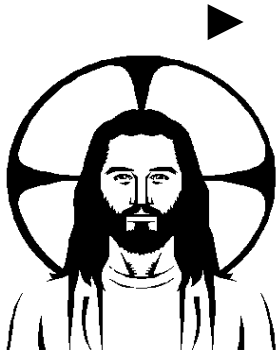

GI come ...

gi come ...

gi come ...

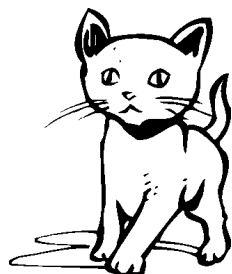
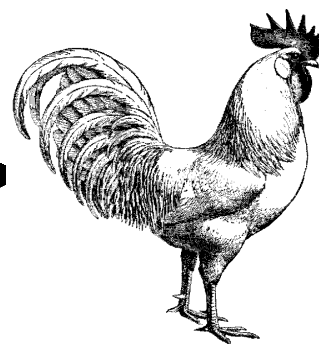
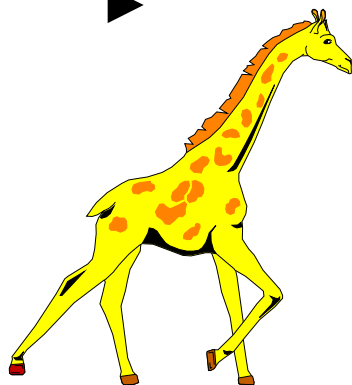

GA come ...

ga come ...

ga come ...

GO go go Go



GONNA
gonna

gonna

Gonna

GO go go Go

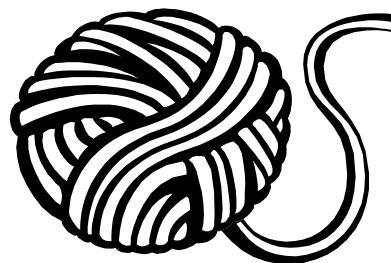

GOMITOLO
gomitolo

gomitolo

Gomitolo

GO go go Go

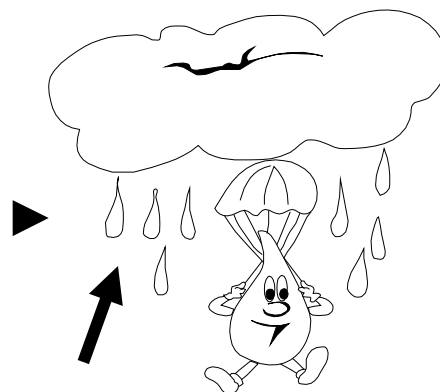

GOCCE
gocce

gocce

Gocce

Cerca le **GO**

GO GA GO FO GO GE GO
GU GO GI GE GA GO MO
GO VO GO MO GO FO GO

Cerca le **go**

go po go po go gu go vo
po go fo go lo go gi gu
ga gu ga go ga go co go

Cerca le *go*

go gi vo go gi co go gi
go vo go gi vo go ga go
co gi go ga go vo lo go

Cerca le *Go*

Go Io Go Ga Go Gi Vo Mo
Go Go Gi Ge Go Lo Po Gi
Go Gi Go Mo Go Ge Go Lo

Leggi

GO

Go

GO

go

GO

og

og

og

og

og

Go

go

go

go

go

og

Og

og

OG

og

A GO

e go

E GO

I GO

O GO

u go

a go

i go

e go

i go

o go

u go

O go

A GO

e go

i go

O go

u go

u go

a go

Leggi

La gola



Il lago

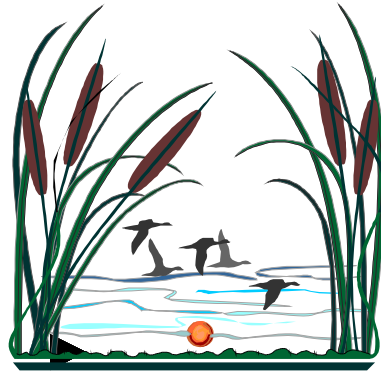

La gota

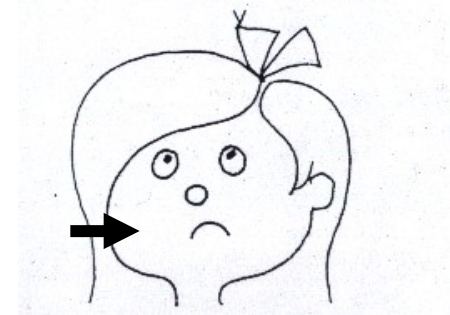

Il fagotto

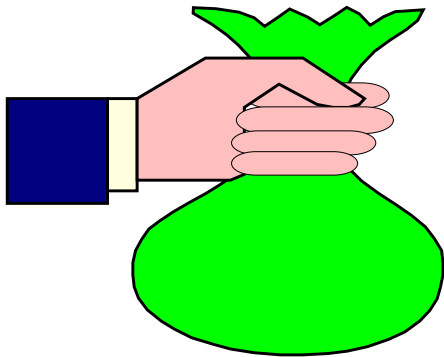

L'ago

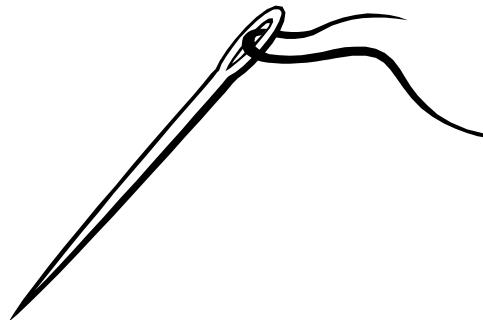

Le gocce



Leggi

Il sugo

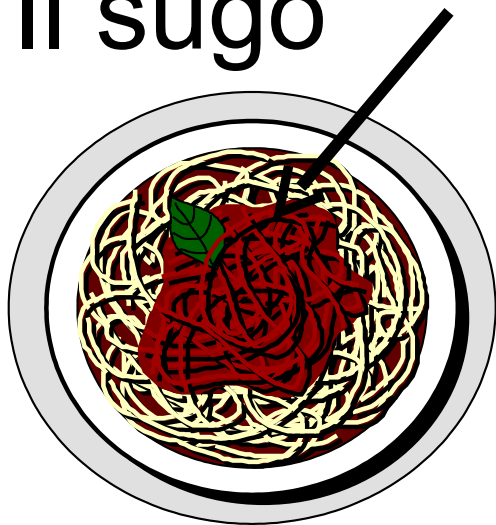

Le tegole



Il borgo

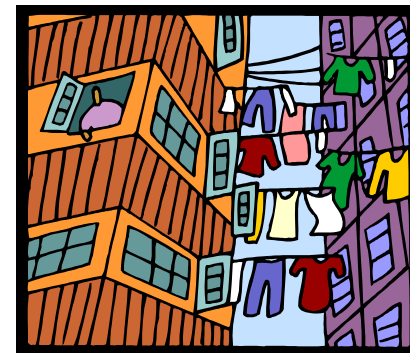

Il gorilla



Goloso



Il golfo

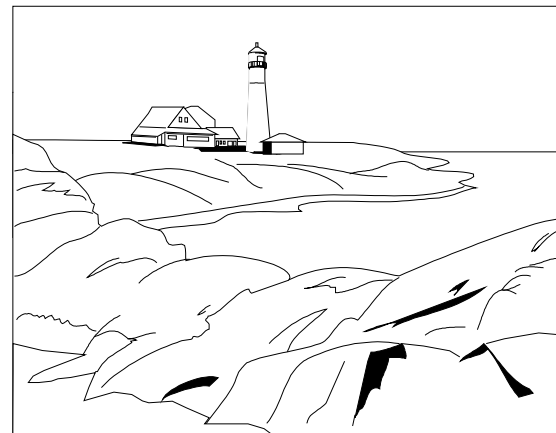

Leggi

Il gorilla è forte



La gola è arrossata

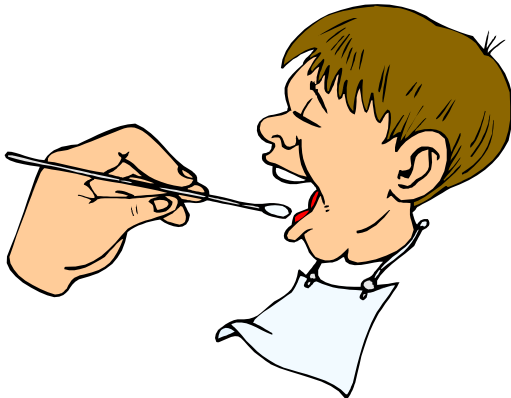

Le gocce di pioggia



Il lago è bello

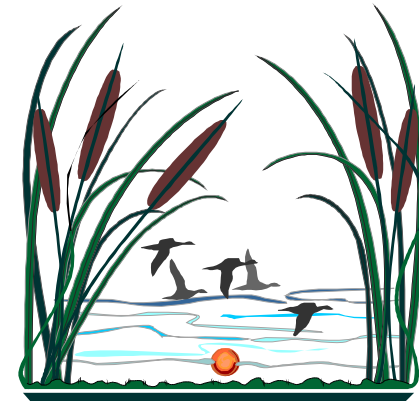

Leggi e associa

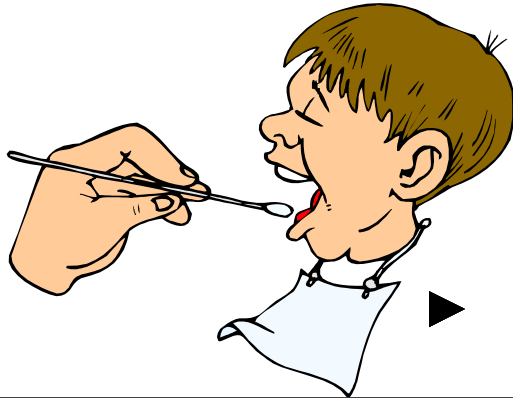
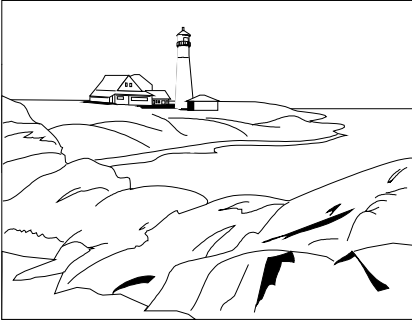

Le tegole

Il golfo

La gola

Il gorilla

Leggi

**Go la*

go va

CE FO

Lo Og

VA Ve

go fa

pa go

ce vi

te va

GO PO

Co go

go va

O go

E VA

O go

O vi

I VA

u go

O cu

u va

o go

a co

a va

i li

O go

a lo

i VE

GO come ...
go come...

go come ...

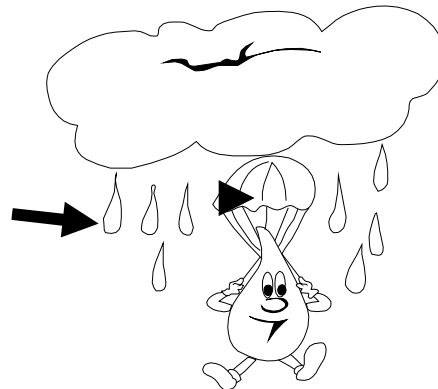
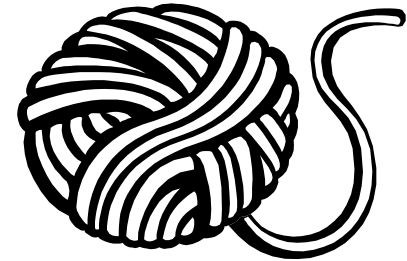
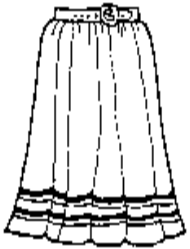

GO come ...

go come ...

go come ...

GI come ...

gi come ...

gi come ...

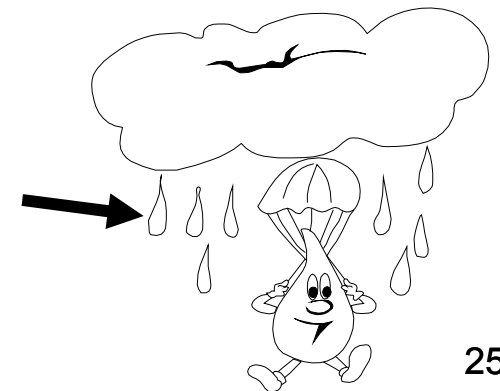
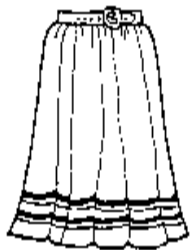
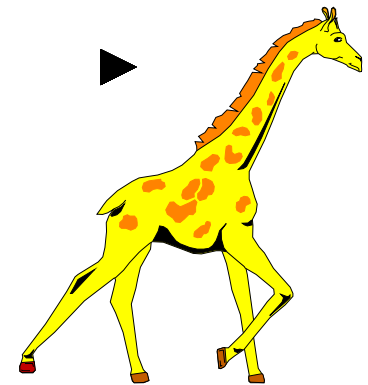
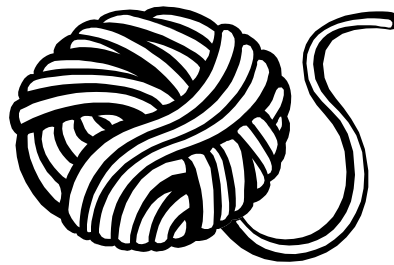

GO come ...

go come ...

go come ...

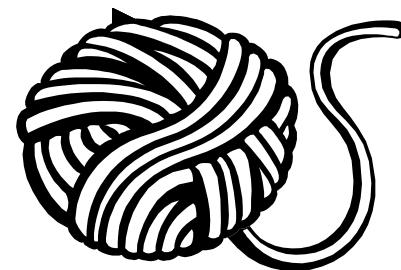
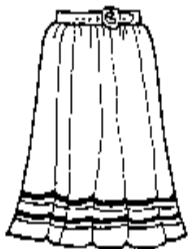

GE come ...

ge come ...

ge come ...

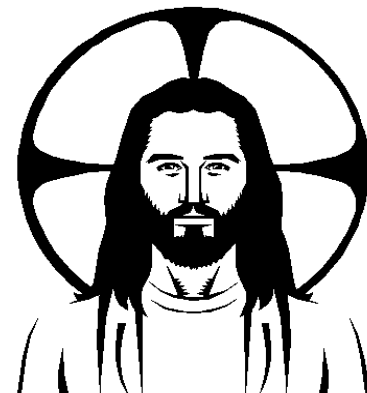
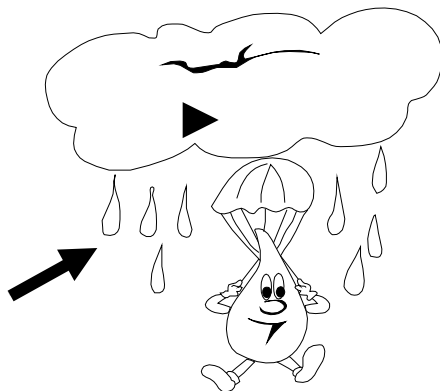
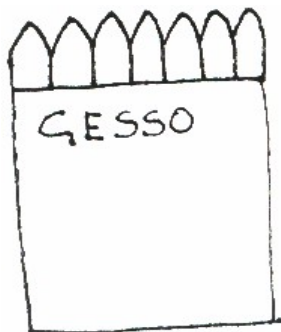

GU gu *gu* *Gu*

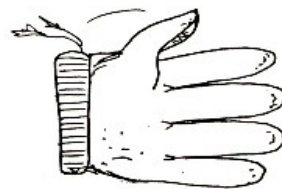

GUANTI

guanti

guanti

Guanti

GU gu *gu* *Gu*

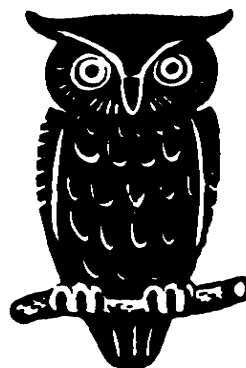

GUFO

gufo

gufo

Gufo

GU gu *gu* *Gu*

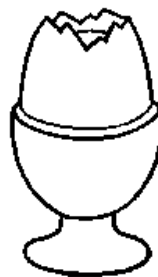

GUSCIO

guscio

guscio

Cerca le **GU**

GU FU GU MU GE TU GU
TU GU GI GE ZU GU GA
GE VU GU GA GI FU GU

Cerca le **gu**

gu ge gu ga gu cu gu vu
pu gu go gu lu gu gi pu
gu cu ga gu ga gu cu ga

Cerca le *gu*

gu gi vu qu ge cu gu mu
gu mu qu gi go qu ga gu
ge vu qu ga qu vu lu qu

Cerca le *Gu*

Gu Ga Gu Pu Gu Ge Gu Vu
Gu Go Gi Gu Gi Vu Ge Gu
Vu Gu Ga Mu Gu Lu Gu Lu

Leggi

GU

Gu

GU

gu

GU

ug

ug

ug

Ug

ug

gu

gu

gu

gu

gu

ug

Ug

ug

UG

ug

A GU

e gu

E GU

I GU

O GU

u gu

a gu

i gu

e gu

i gu

o gu

u gu

O gu

A GU

e gu

i gu

O gu

u gu

u gu

a gu

Leggi

Il paguro

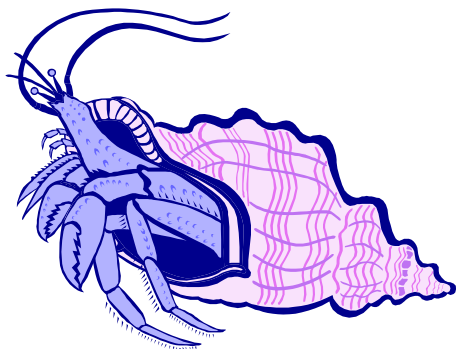

Il gufo

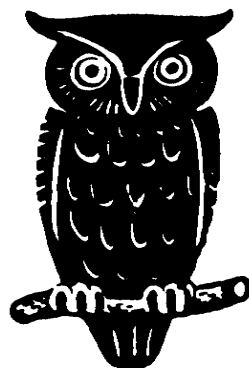

La Liguria



La figura



Il ragù

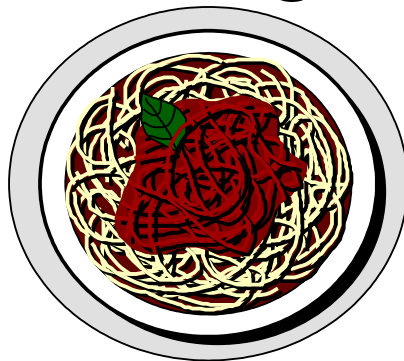

Ragusa



Leggi

Il ragù è rosso

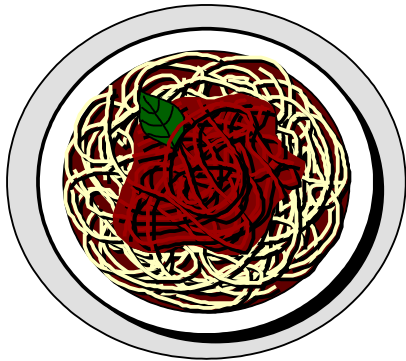

Dov'è il gufo?

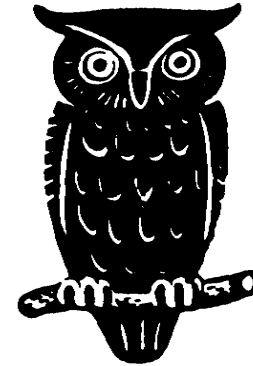

Il lupo di Gubbio

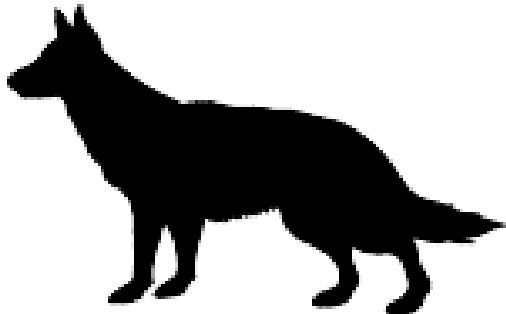

Il paguro è piccolo

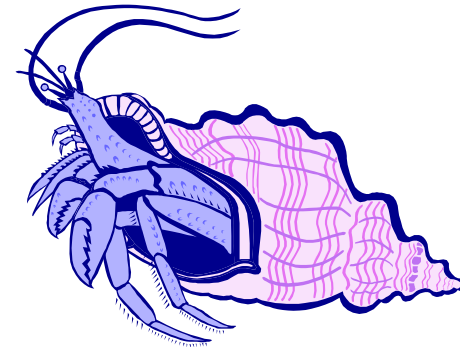



Leggi e associa

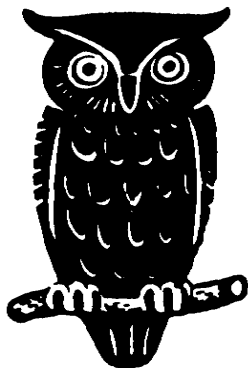
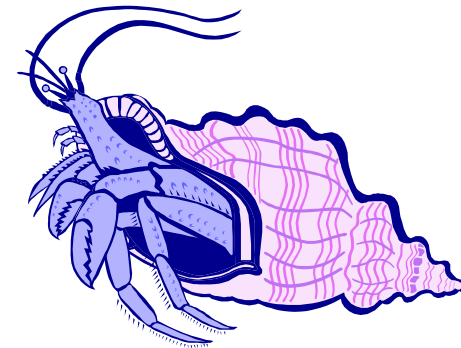

Il gufo

Ragusa

Il paguro

Il ragù

Leggi

Gu Go

gu gi

GU GO

Gi Gu

GU GE

gu ga

ge gu

Du gu

Gu do

GU DI

de gu

gu da

O gu

E GO

O gu

O gi

I GU

u gu

O ge

u ga

o gu

a du

a gu

i di

O gu

a do

i DE

GU come ...

gu come...

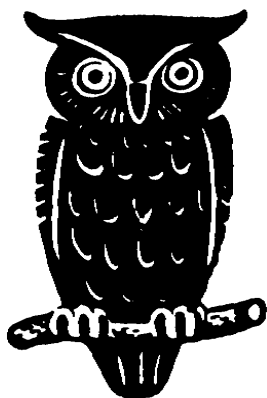

gu

come ...

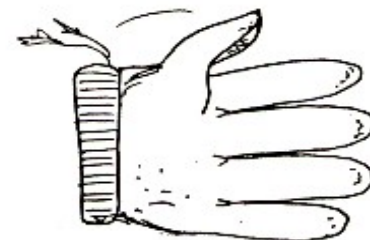
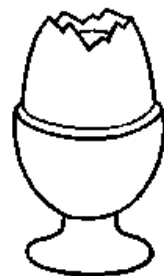

GU come ...

gu come ...

gu come ...

GO come ...

go come ...

go come ...

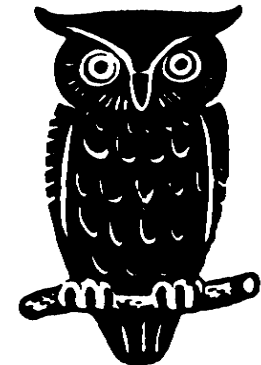
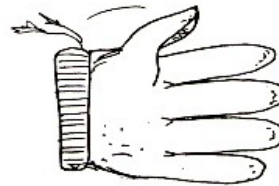
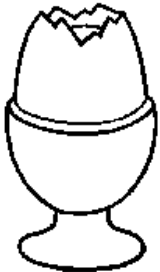
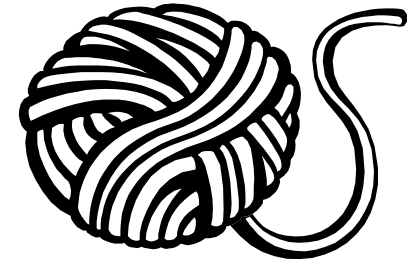
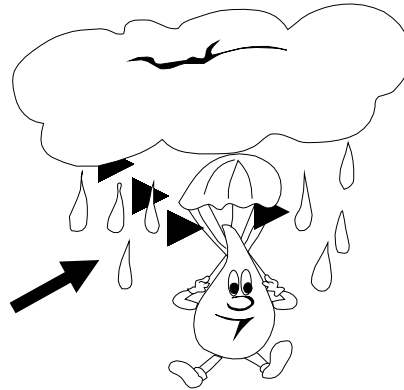
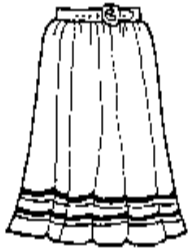

GU come ...

gu come ...

gu come ...

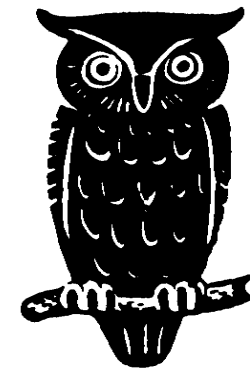
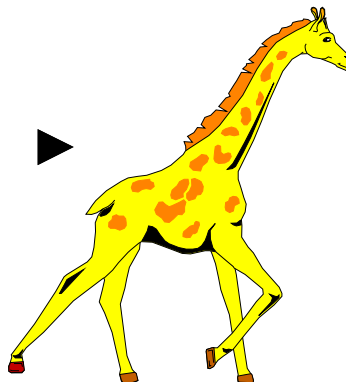
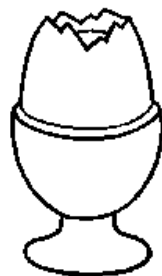
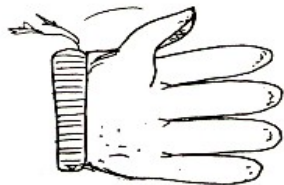

GI come ...

gi come ...

gi come ...

MA ma *ma Ma*



MATITA
matita

matita

Matita

MA ma *ma Ma*



MARTELLLO
martello

martello

Martello

MA ma *ma Ma*

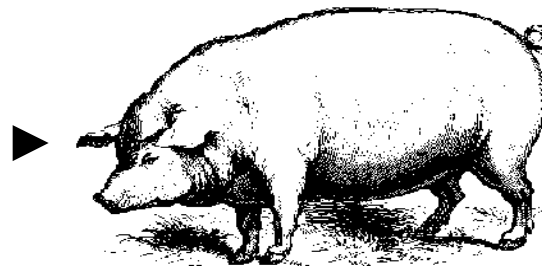

MAIALE
maiale

maiale

Cerca le MA

MO FA MA NA MA ME MA

MU MA MI VA ZA ME MA

ME VA MA GA MI FA MA

Cerca le ma

ma me ma pa ma mu ma va

pa ma mi ma mo ga mi mu

ma ca la ma fa ma mo ma

Cerca le *ma*

ma mi va ma me ca ma mi

ma mi ma va mo ma ga ma

me va ma la ma va mi ma

Cerca le *Ma*

Mi Me Ma Ia Ma Pa Ma La

Mi Ma Me Mi Ma Va Me Ma

Ma Ma Ga Ma Ga Me Ma Ga

Leggi

MA

Ma

MA

ma

MA

am

am

am

am

am

Ma

ma

ma

ma

ma

am

Am

am

am

am

A MA

e ma

E MA

I MA

O MA

u ma

a ma

i ma

e ma

i ma

o ma

u ma

O ma

A MA

e ma

i ma

O ma

u ma

u ma

a ma

Leggi

Le matite

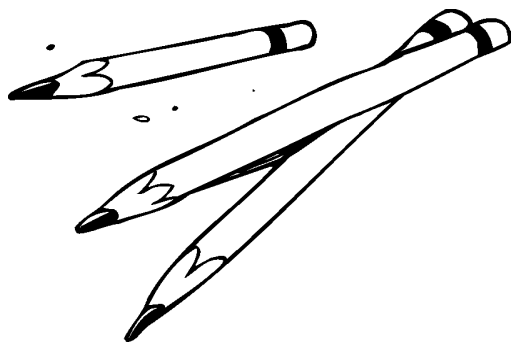

Il martello



Il maiale

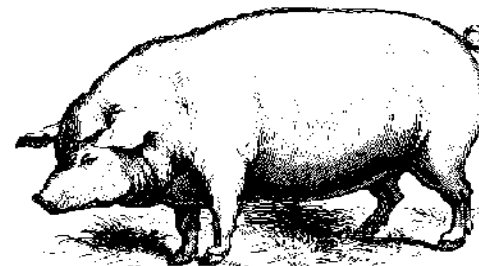

Il mare

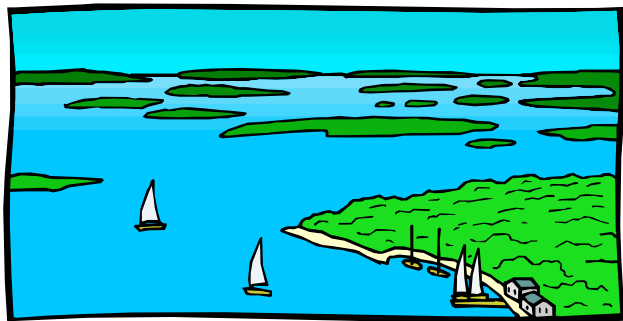

La mamma



Marco

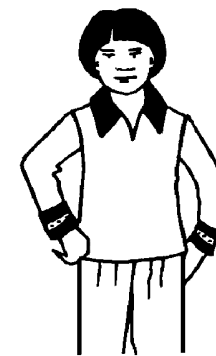

Leggi

Amare

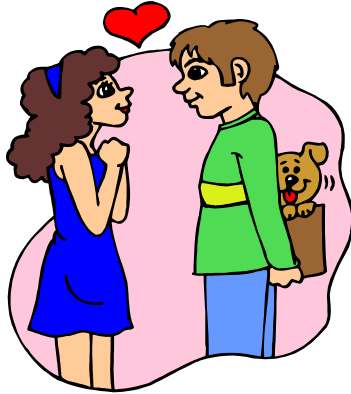

La mappa



La magia



Il macellaio

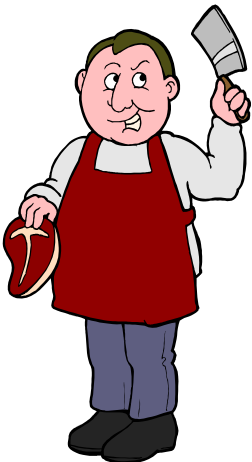

Malata

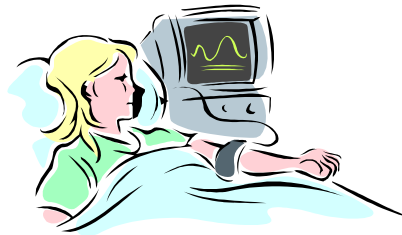

Il mais



Leggi

La mamma e il piccolo

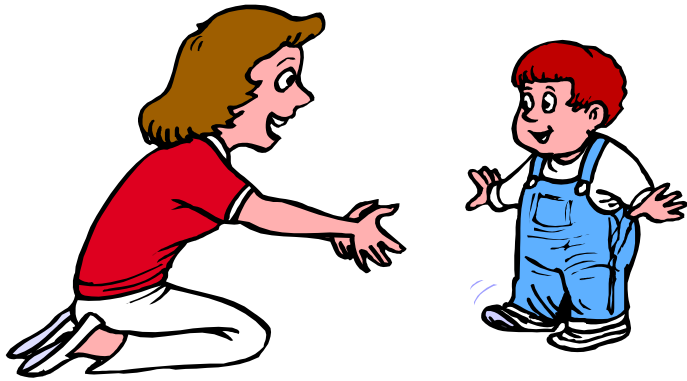

Il maiale è rosa

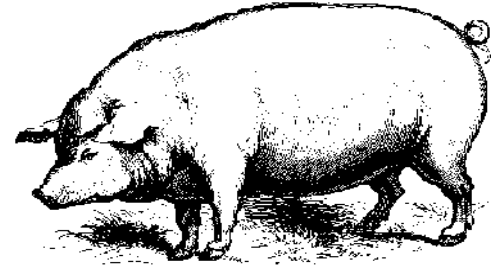

Il mare è bello

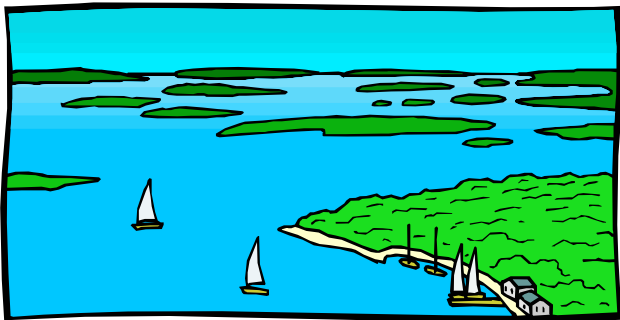

Il martello batte



Leggi e associa

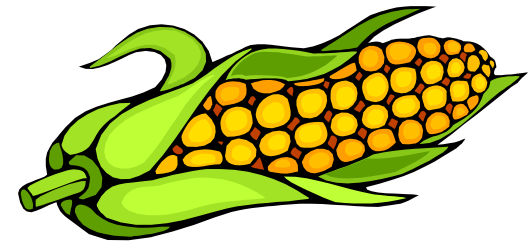
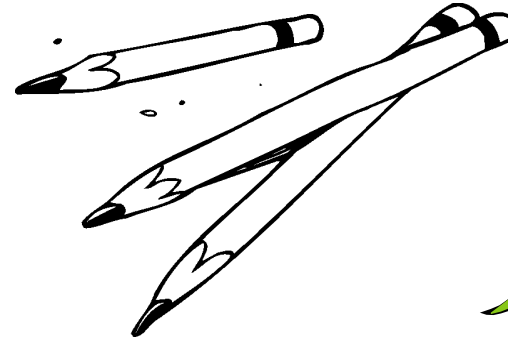
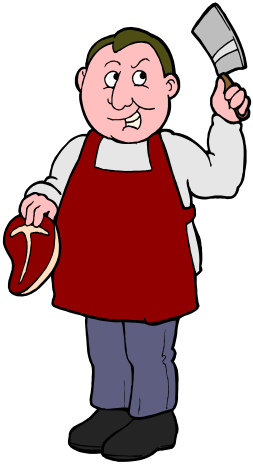

Il mais

Il macellaio

Le matite

Il martello

Leggi

Ma gu

ma gi

MA GO

Gi ma

Go ma

ma gu

ge ma

Ma ga

Ma du

MA DO

di ma

ma de

O ma

E go

O ma

O gu

I ma

u ma

O gi

u ge

o ma

a ga

a du

i do

O ma

a di

i ma

MA come ...
ma come...

ma *come ...*

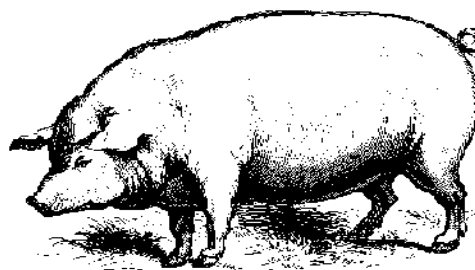
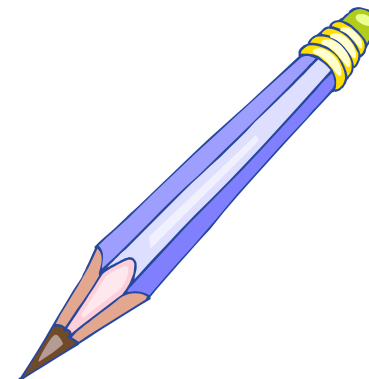

MA come ...

ma come ...

ma come ...

GU come ...

gu come ...

gu come ...

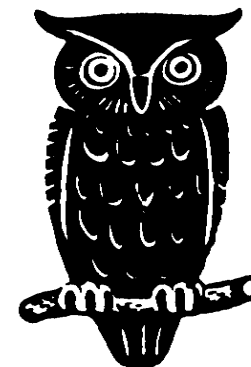
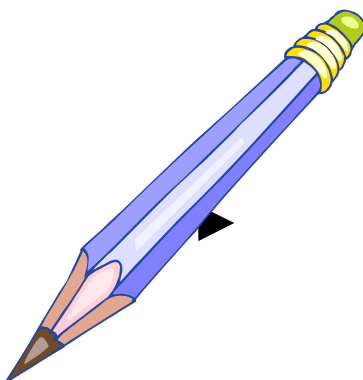
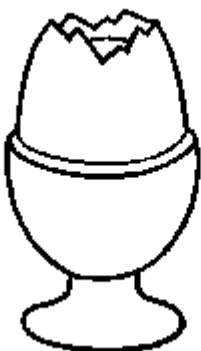
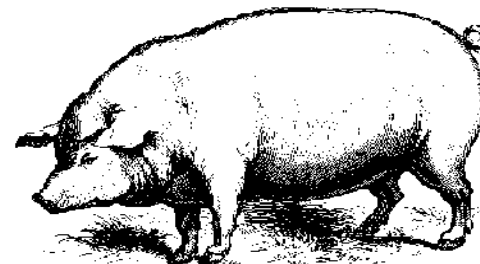
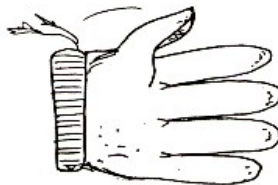

MA come ...

ma come ...

ma *come* ▶

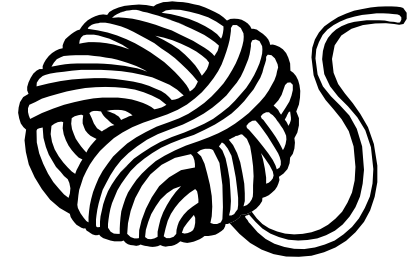
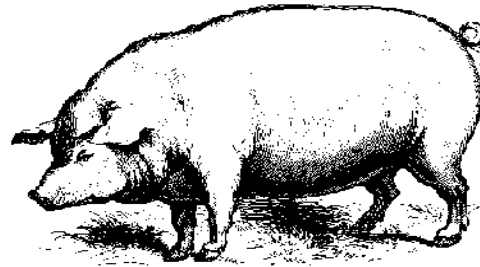

GO come ...

go come ...

go

come ...

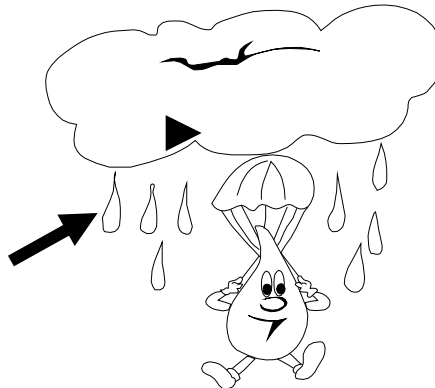
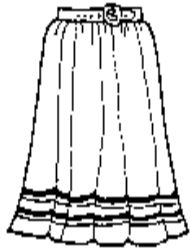

ME me me Me



MEDICINA
medicina

medicina

Medicina

ME me me Me

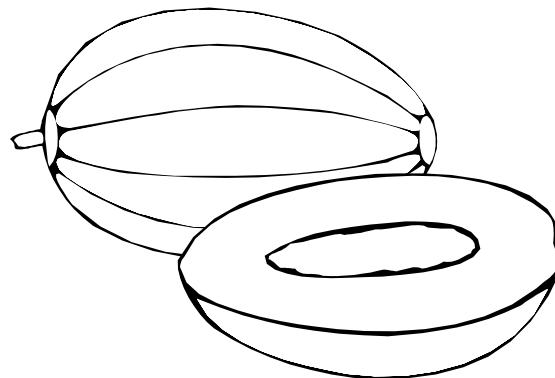

MELONE
melone

melone

Melone

ME me me Me

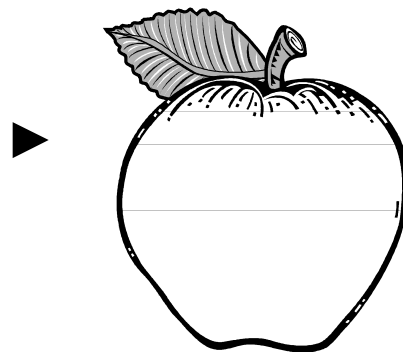

MELA
mela

mela

Cerca le ME

ME FE MA MO ME TE ME
TE ME MI VE ZE ME MA
ME MI ME MU MA FE ME

Cerca le me

me pe me ge ma mu me ve
pe me mo me mi me le me
me ce le me mo ma mi me

Cerca le *me*

me mi ma me mi ce me mi

me ve me mi ve me ge me

me ve ma le me ma le me

Cerca le *Me*

Me Mi Me Mi Pe Ma Me Le

Me Ma Me Ge Me Ve Me Ma

Ve Me Mu Me Ge Le Me Ma

Leggi

ME

Me

ME

me

ME

em

em

em

em

em

me

me

me

me

me

em

Em

em

em

em

A ME

e me

E ME

I ME

O ME

u me

a me

i me

e me

i me

o me

u me

O me

A ME

e me

i me

O me

u me

u me

a me

Leggi

Il merlo



Pamela



La mela

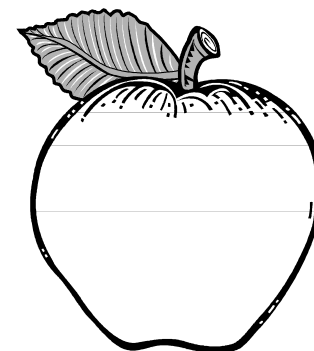

La medusa



Il cammello

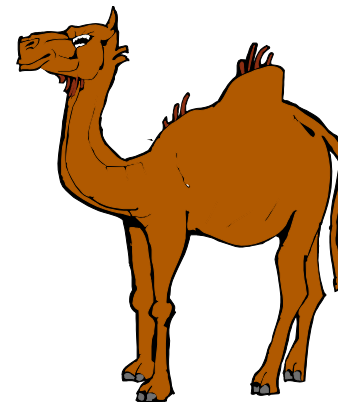

La caramella

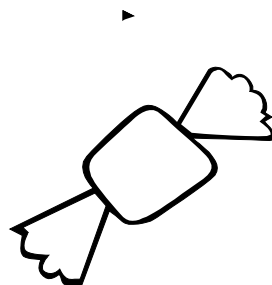

Leggi

La lametta

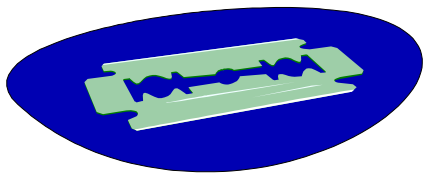

Le cime



Il medico

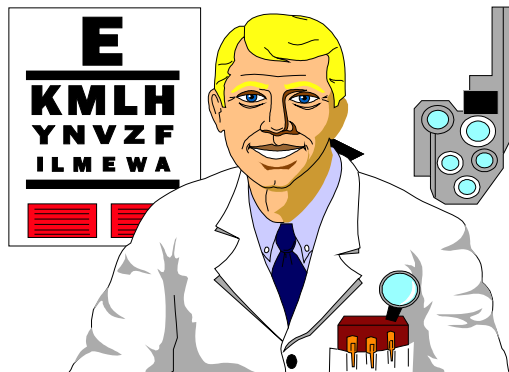

Il lume



La fame



Le dame

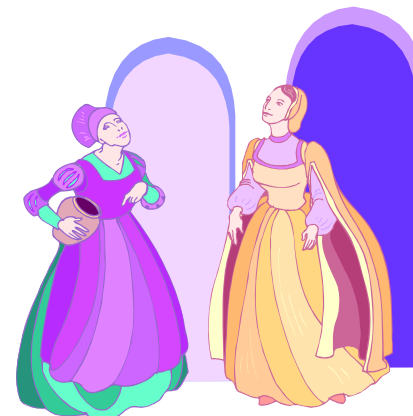

Leggi

Il medico e Marco

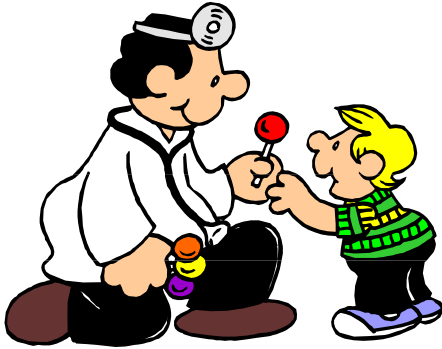

Il lume fa luce



Il cammello ha sete

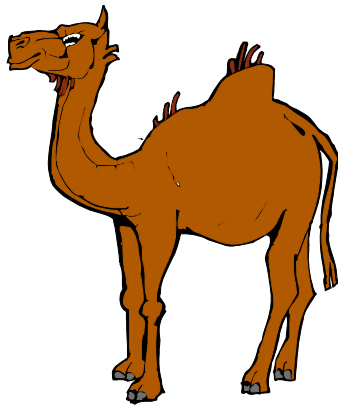

Vuoi la caramella?

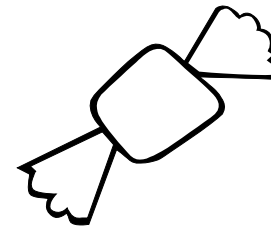

Leggi e associa

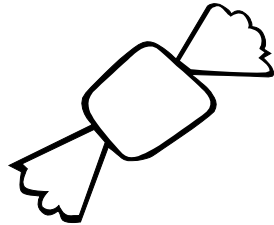
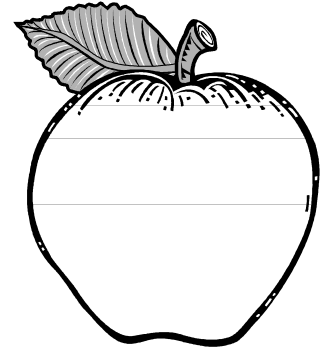

La mela

La medusa

Il lume

La caramella

Leggi

Me ma

me gu

ME GO

Me ma

Me go

me gi

gu me

Ge me

Me ga

ME DU

do me

me di

O me

E GU

O ma

O me

I GO

u me

O gi

u ge

o me

a ga

a me

i du

O me

a do

i me

ME come ...
me come...

me *come ...*

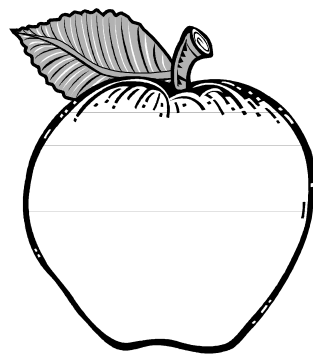
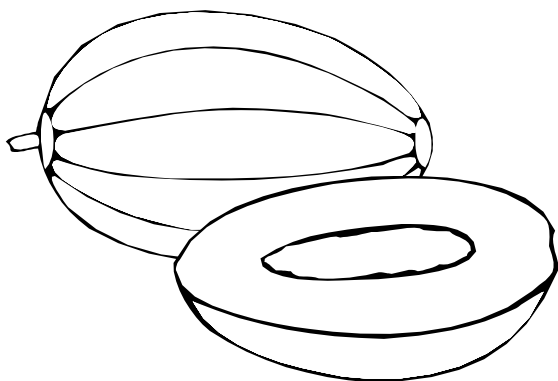

ME come ...

me come ...

me come ...

MA come ...

ma come ...

ma come ...

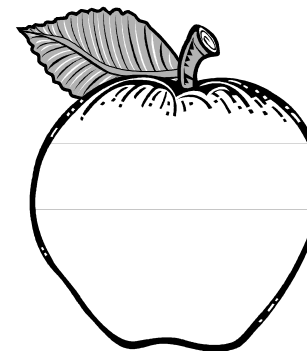
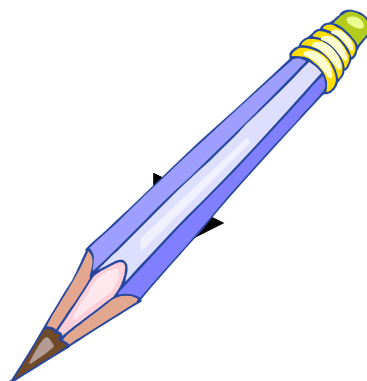
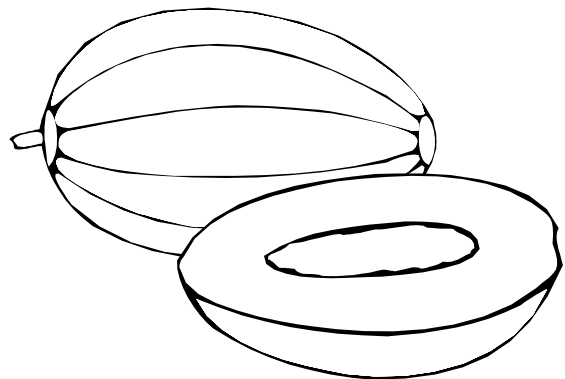
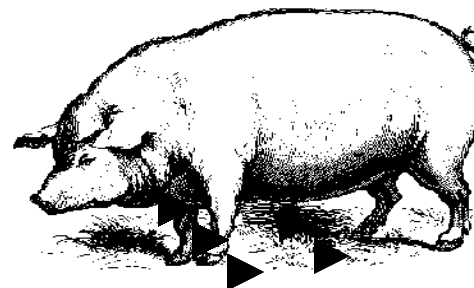

ME come ...

me come ...

me come ...

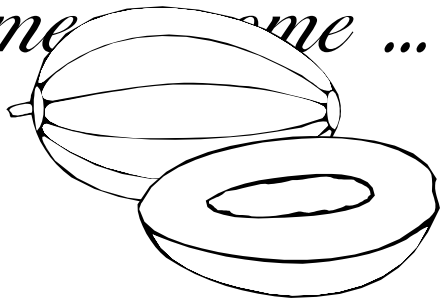

GU come ...

gu come ...

gu come ...

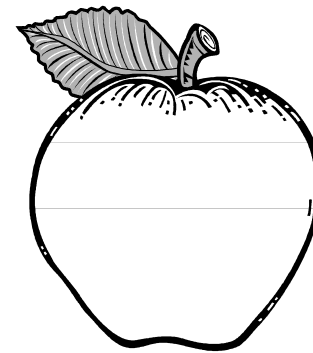
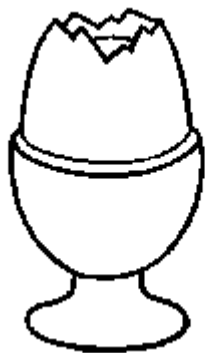
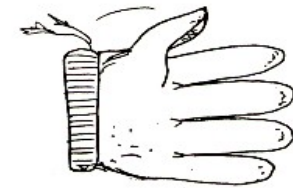

MI mi mi Mi



MIELE
miele
miele
Miele

MI mi mi Mi

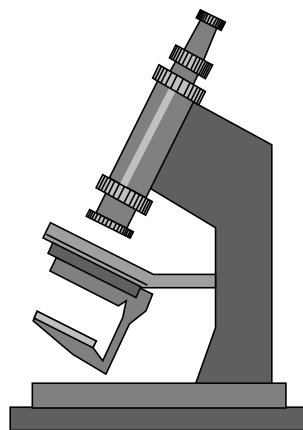

MICROSCOPIO
microscopio
microscopio
Microscopio

MI mi mi Mi

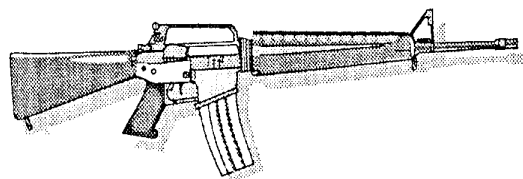

MITRA
mitra

mitra

Cerca le **MI**

MI **FI** **MA** **FI** **MI** **TI** **MI**
TI **MI** **ME** **VI** **MO** **MI** **MA**
ME **VI** **MI** **GI** **MA** **MO** **MI**

Cerca le **mi**

mi **me** **mi** **pi** **mi** **mu** **mi** **vi**
pi **mi** **mo** **mi** **li** **mi** **li** **mu**
ma **mi** **li** **mi** **fi** **ma** **mo** **mi**

Cerca le *mi*

mi me ma mi me ci mi ti
mi vi mo mi mo mi gi ma
ci mi ma mi li mi li mi

Cerca le *Mi*

Ma Mi Pi Mi Li Mi Vi Mo
Mi Ma Mi Gi Mi Ma Me Mi
Mo Mi Gi Mi Fi Me Mi Si

Leggi

MI	<i>Mi</i>	MI	mi	MI
im	<i>im</i>	im	<i>Im</i>	im
<i>mi</i>	mi	Mi	<i>mi</i>	mi
im	<i>Im</i>	im	<i>im</i>	im

A MI	<i>e mi</i>	E MI	I MI	O MI
u mi	<i>a mi</i>	i mi	e mi	i mi
<i>o mi</i>	u mi	O mi	A MI	e mi
i mi	<i>O mi</i>	u mi	u mi	a mi

Leggi

Il micio

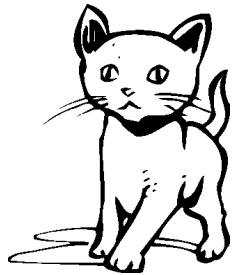

Il miele

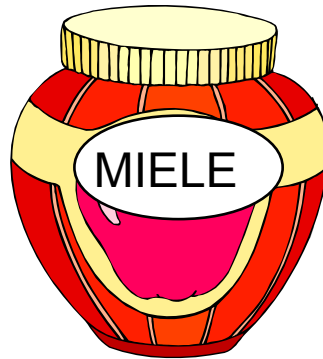

La formica

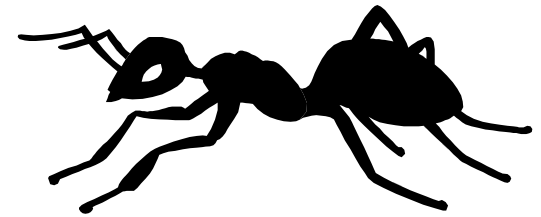

L'amido



▶
Miriam



Il millepiedi

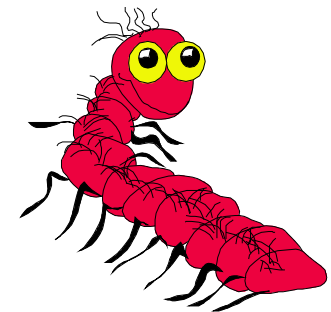

Leggi

L'amico



Mirco



Il gomitolo

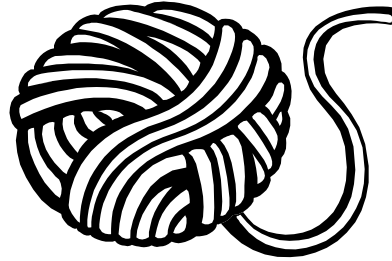

La camicia

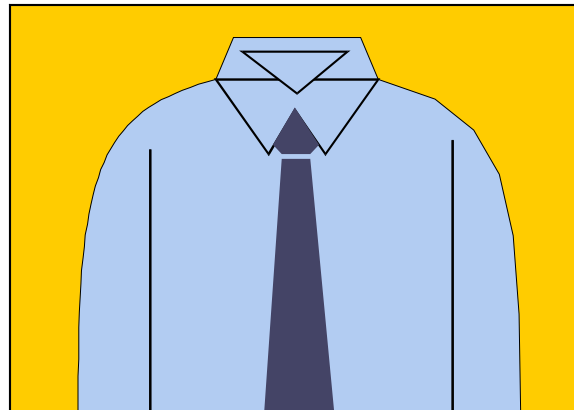

I lumi



Il camice



Leggi

Il mio micio miagola



Il miele è dolce

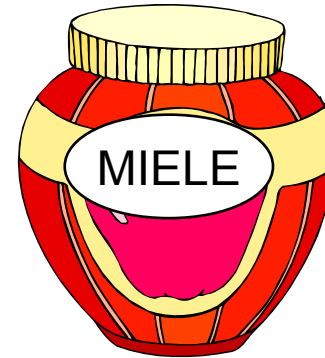

L'amico di Mirco

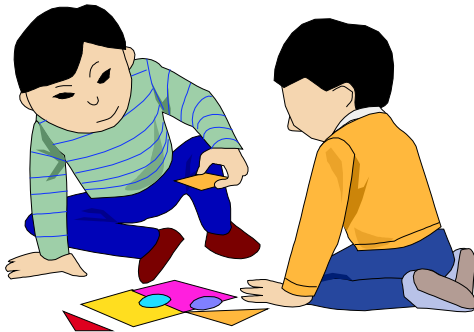

La camicia è pulita

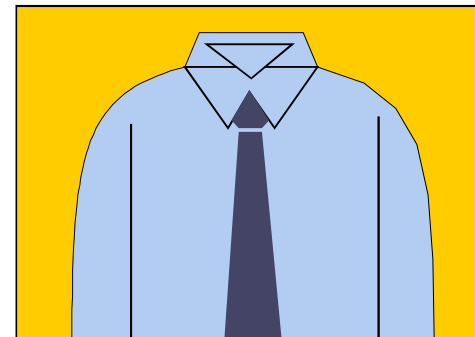

Leggi e associa

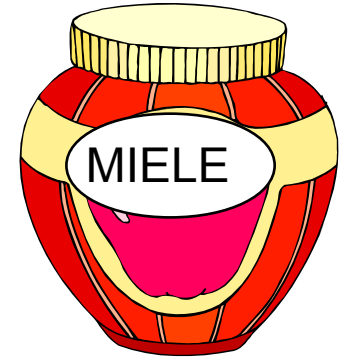
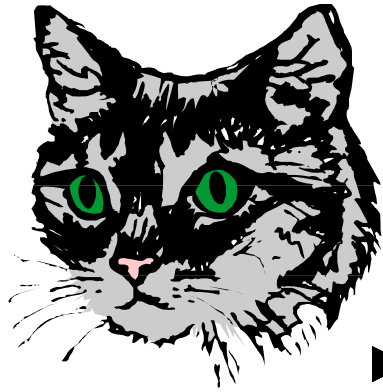
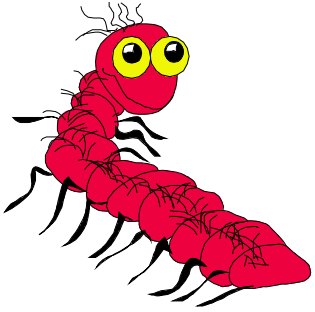

La formica

Il millepiedi

Il micio

Il miele

Leggi

<i>Mi me</i>	mi ma	Mi gu	<i>Mi ma</i>
Mi me	<i>mi gu</i>	go mi	Gi mi
<i>Ge mi</i>	MI GA	<i>Do mi</i>	mi du

O mi	E ME	O mi	<i>O ma</i>	I MI
<i>u mi</i>	<i>O gu</i>	u go	o mi	a gi
<i>a mi</i>	i ge	<i>O mi</i>	a ga	i du

MI come ...
mi come...

mi *come ...*

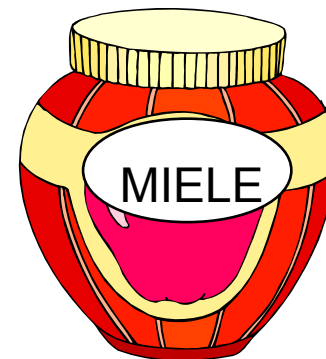
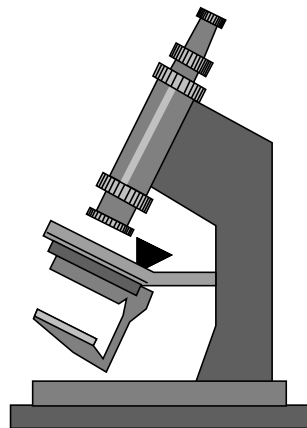
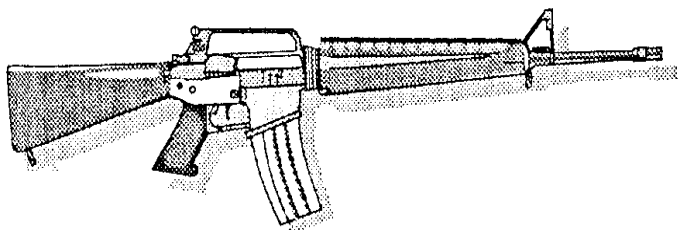

MI come ...

mi come ...

mi come ...

ME come ...

me come ...

me come ...

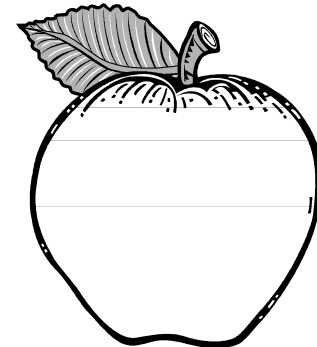
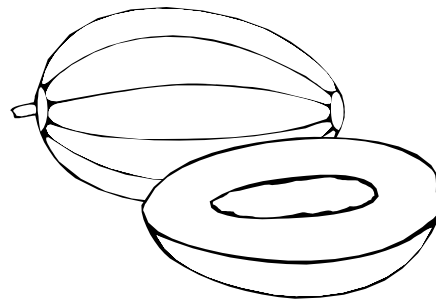
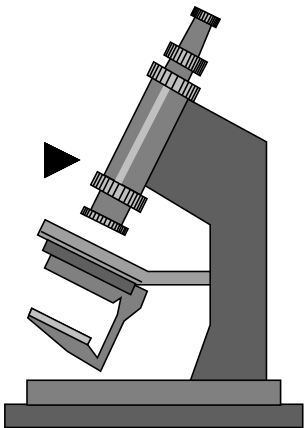
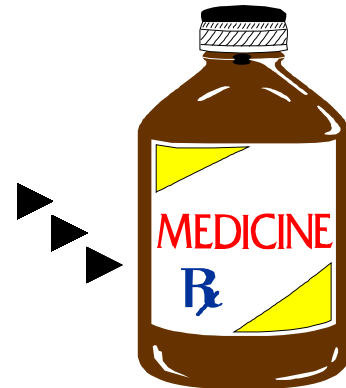
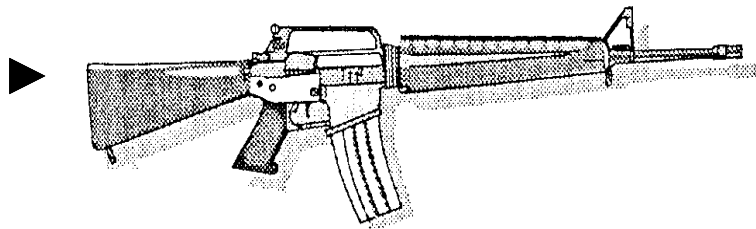

MI come ...

mi come ...

mi come ...

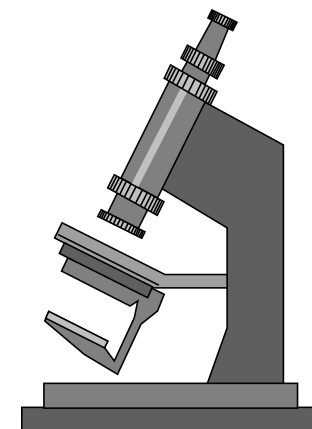
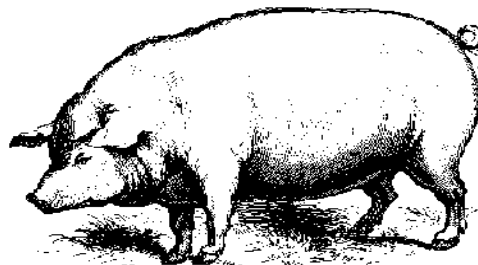
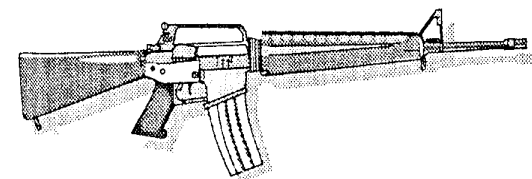
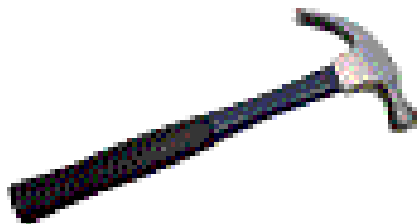
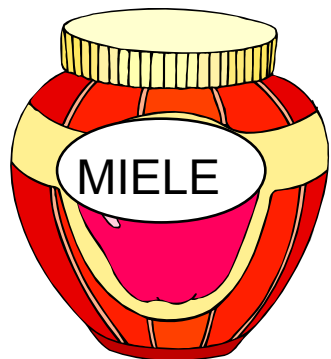

MA come ...

ma come ...

ma come ...

MO mo *mo Mo*

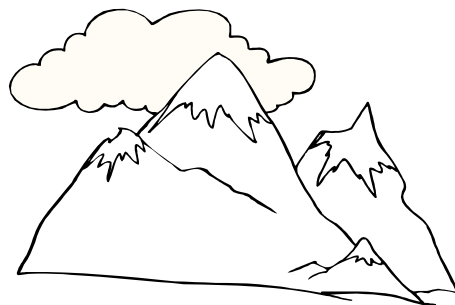

MONTAGNE
montagne

montagne

Montagne

MO mo *mo Mo*



MOTO
moto

moto

Moto

MO mo *mo Mo*

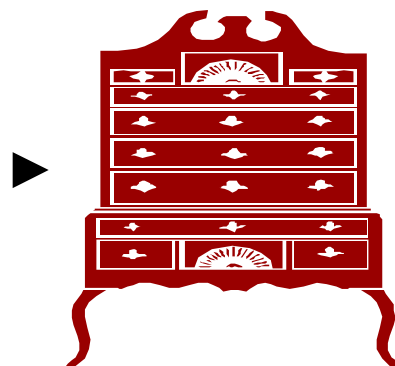

MOBILE
mobile

mobile

Mobile

Cerca le MO

MO ME MA FO MO ME MO
TO MO MU VO ZO MO MA
MA VO MO GO MA FO MO

Cerca le mo

mo me mo po mo co mo ma
me mo fo mo no mu lo mo
mo co lo mo mu ma me mo

Cerca le *mo*

mo me mo me mo co mo to

mo vo mo me vo mo me ma

co mo ma mi mo vo lo mo

Cerca le *Mo*

Ma Mo Vo Mo Ma Me Po Mo

Mo Ma Mo Go Mo Fo Me Mo

Bo Mo Ma Mo Fo Me Mo So

Leggi

MO	<i>Mo</i>	MO	mo	MO
om	<i>om</i>	om	<i>Om</i>	om
<i>Mo</i>	mo	Mo	<i>mo</i>	mo
om	<i>Om</i>	om	<i>om</i>	om

A MO	<i>e mo</i>	E MO	I MO	O MO
u mo	<i>a mo</i>	i mo	e mo	i mo
<i>o mo</i>	u mo	O mo	A MO	e mo
i mo	<i>O mo</i>	u mo	u mo	a mo

Leggi

La moto



Il mobile

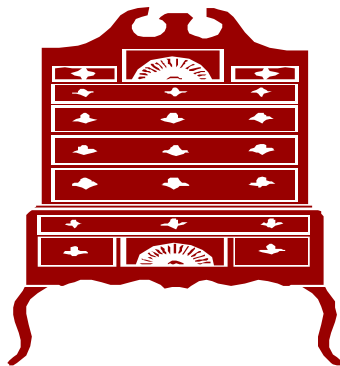

I pomodori



Le more



Il ramo

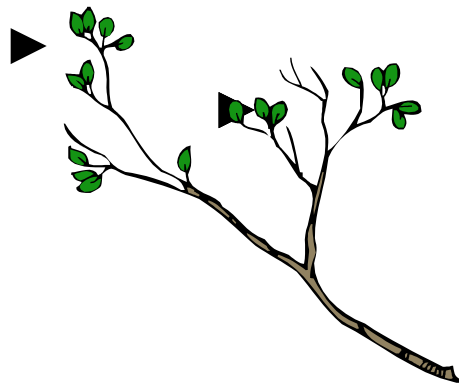

Il molo

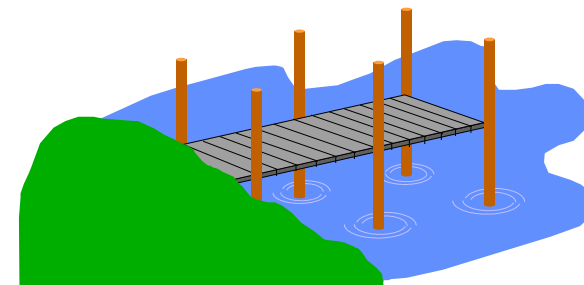

Leggi

La modella

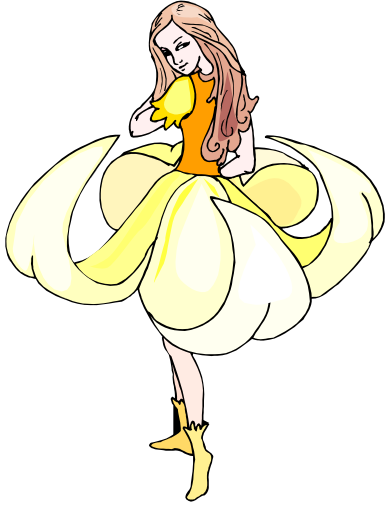

La mortadella

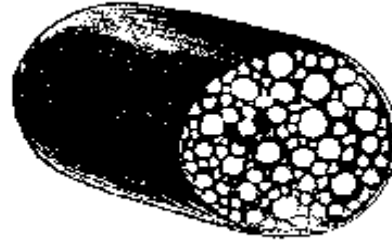

Il fumo

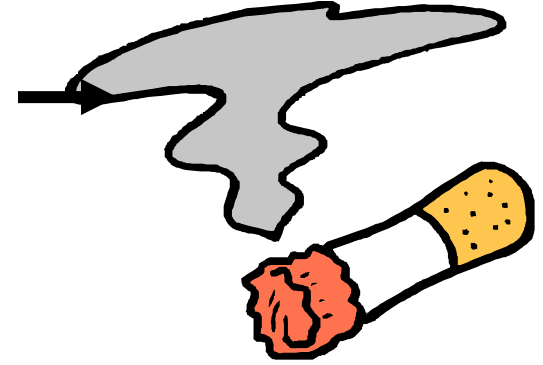

Il motore

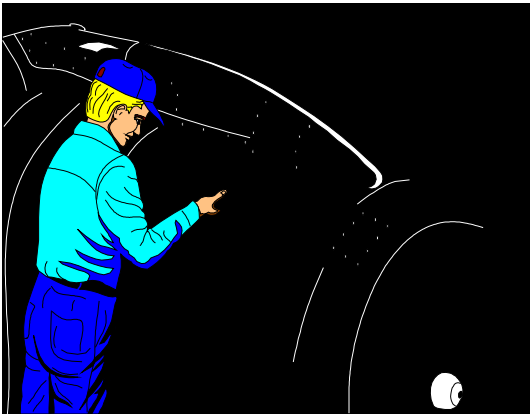

Le mollette

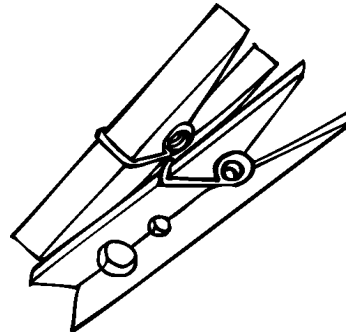

Mordere

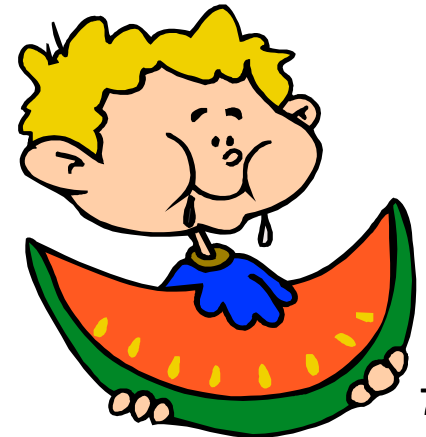

Leggi

Il pomodoro è maturo

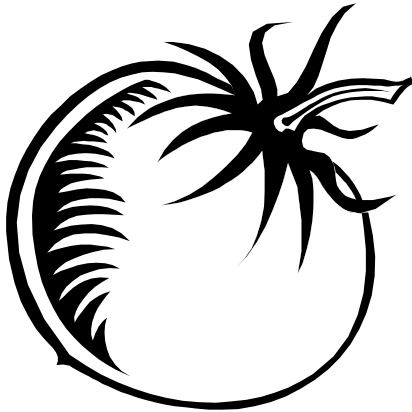

La moto corre



Ecco le more dolci



Il molo è deserto

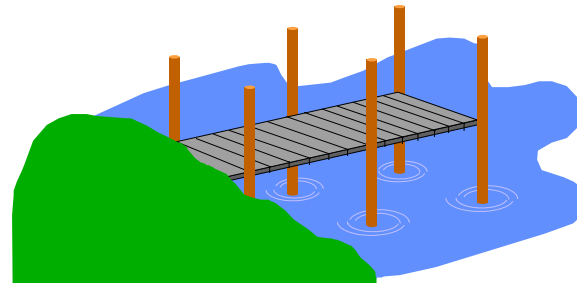

Leggi e associa

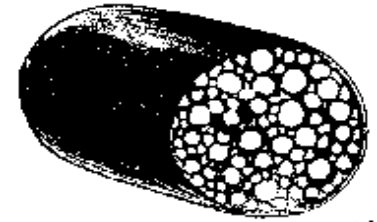
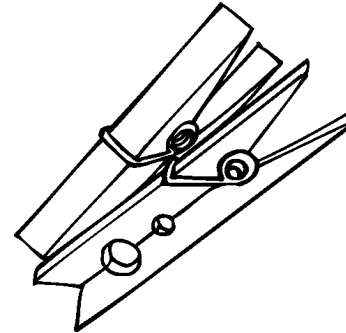
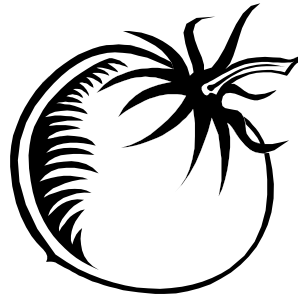

La moto

Le mollette

La mortadella

Il pomodoro

Leggi

<i>Mo mi</i>	mo ma	MO ME	<i>Mo mi</i>
Mo ma	<i>mo me</i>	gu mo	Ma go
<i>Mo gi</i>	MO GE	<i>ga mo</i>	mo du

O mo	E mi	O ma	<i>O me</i>	I mo
<i>u mo</i>	<i>O gu</i>	u go	o mo	a gi
<i>a mo</i>	i ge	<i>O mo</i>	a ga	i mo

MO come ...
mo come...

mo

come ...

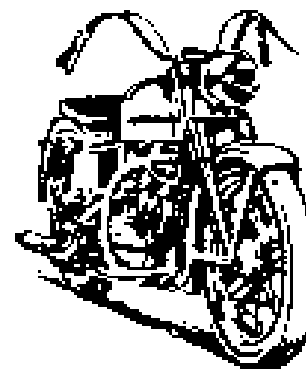
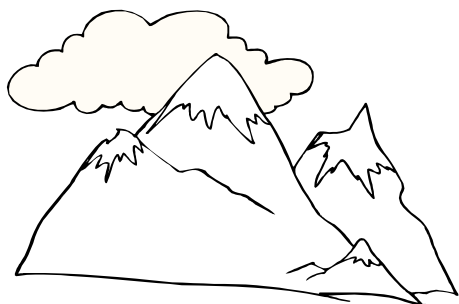

MO come ...

mo come ...

mo come ...

MI come ...

mi come ...

mi come ...

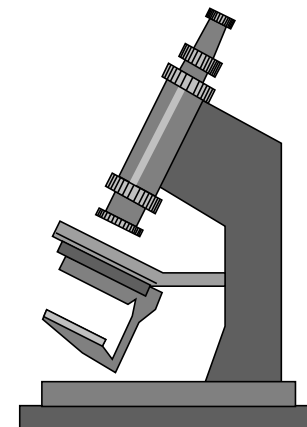
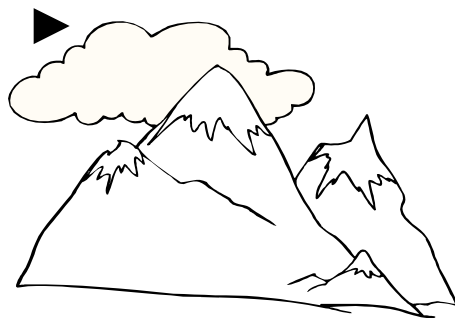
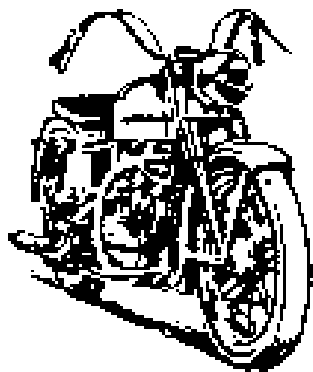
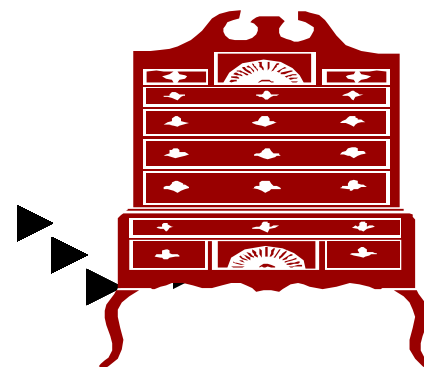
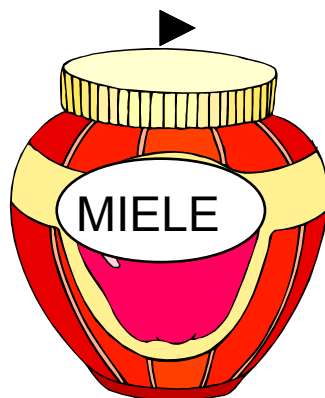
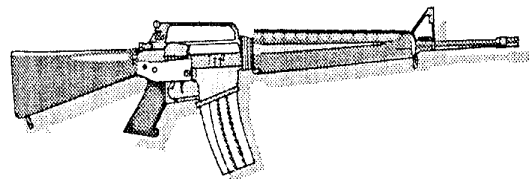

MO come ...

mo come ...

mo come ...

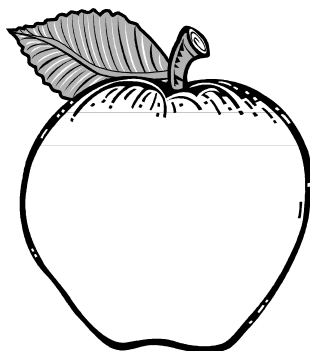
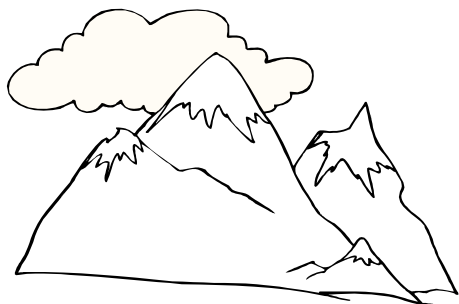
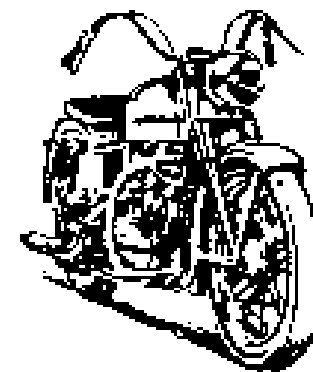
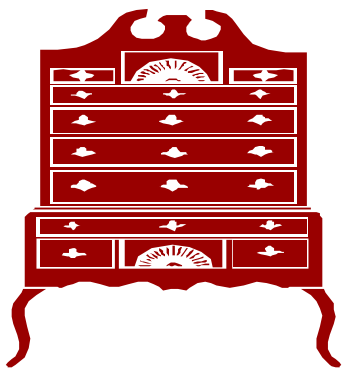
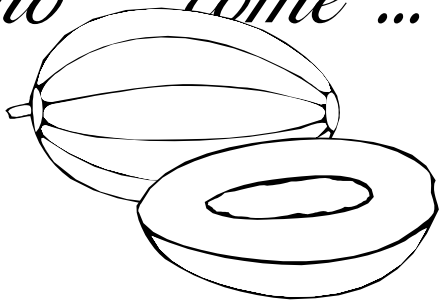

ME come ...

me come ...

me come ...

MU mu *mu Mu*



MUCCA
mucca

mucca

Mucca

MULINO
mulino

mulino

Mulino

MU mu *mu Mu*

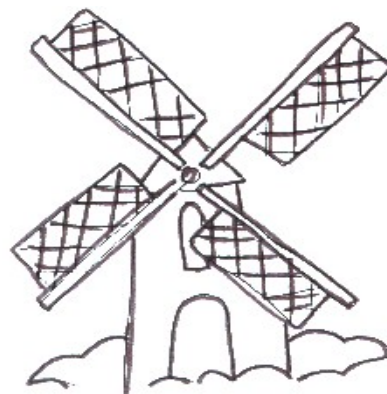

MURO
muro

MU mu *mu Mu*



muro

Muro

Cerca le MU

MU FU MA FU MU ME MU
TU MU MI ME ZU MU MA
MU VU MA GU MA FU MU

Cerca le mu

mu me mu ma mu cu mu vu
me mu fu mu lu gu mi mu
mu cu ma mu mo ma cu mu

Cerca la *mu*

mu me vu mu mo cu mu tu
mu vu mu me vu mu gu ma
me mu ma mu mo mu lu mu

Cerca la *Mu*

Lu Mu Vu Mu Ma Mu Pu Mu
Mu Ma Mi Gu Mu Me Mi Mu
Bu Mu Me Mu Fu Me Mu Su

Leggi

MU

Mu

MU

mu

MU

um

um

um

um

um

mu

mu

Mu

mu

mu

um

Um

um

um

um

A MU

e mu

E MU

I MU

O MU

u mu

a mu

i mu

e mu

i mu

o mu

u mu

O mu

A MU

e mu

i mu

O mu

u mu

u mu

a mu ⁸⁹

Leggi

La mucca



La musica



Il muro



Il mulo



La mummia

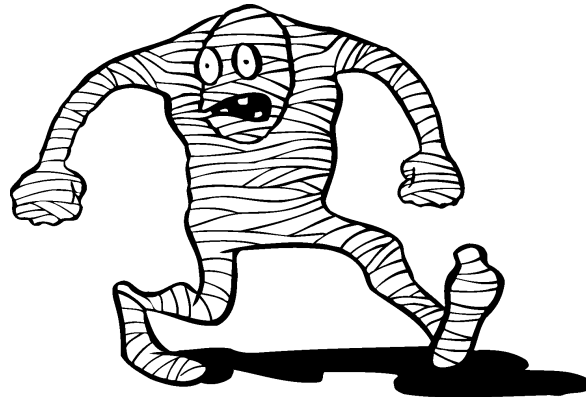

Il muratore

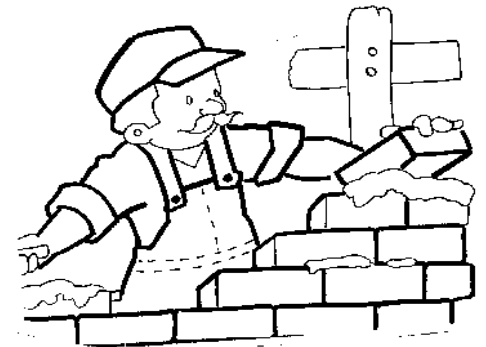

Leggi

Il muletto

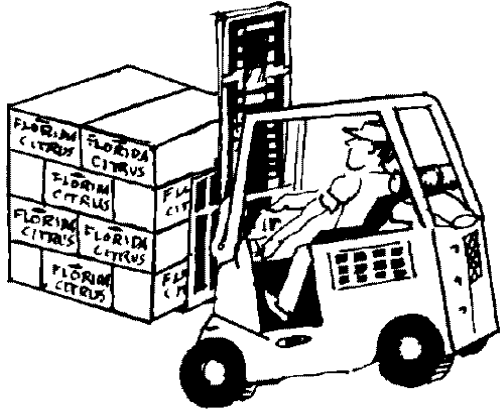

La musa



Il museo

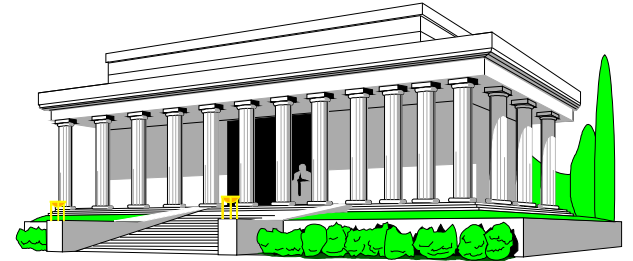

La mulattiera



La multa



Leggi

Il vigile fa la multa La mucca si riposa



Il mulo è cocciuto



Il museo è deserto

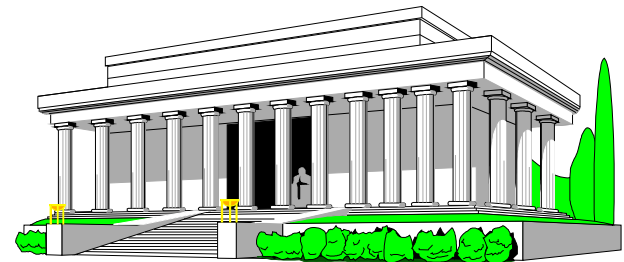

leggi e associa

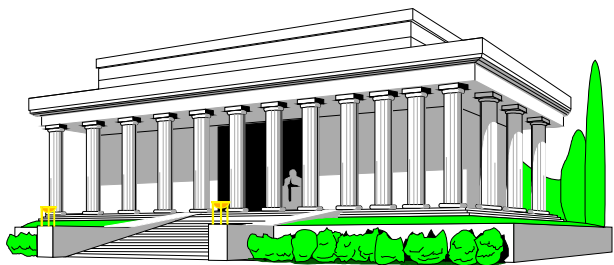
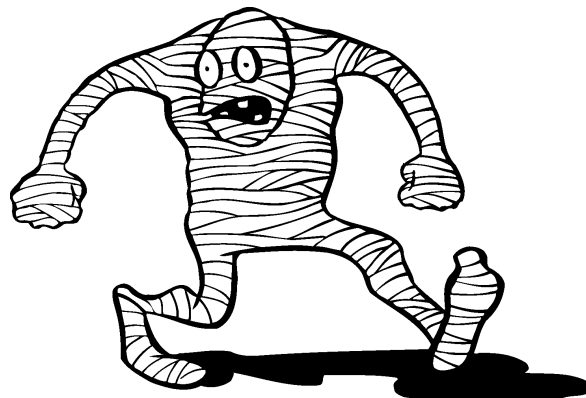

La mucca

La mummia

Il mulo

Il museo

Leggi

Mu mo

mu mi

MU ME

Mu mo

Mu mi

mu me

mu mi

Mu ma

Mu gu

MU GO

gi mu

mu ge

O mu

E MO

O mu

O mi

I mu

u mu

O me

u ma

o mu

a gu

a go

i gi

O mu

a ge

i mu

MU come ...
mu come...

mu *come ...*

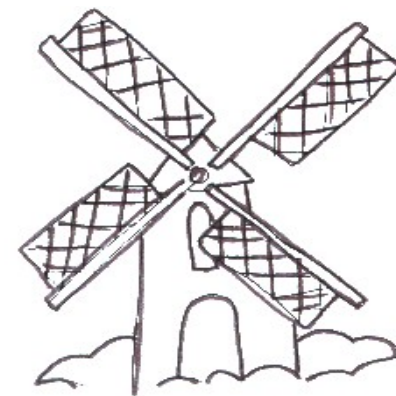

MU come ...

mu come ...

mu come ...

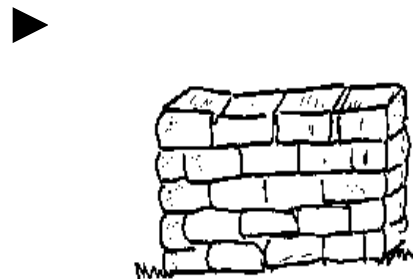
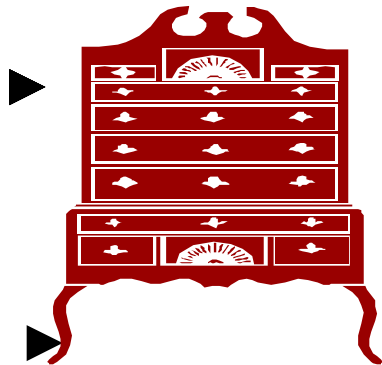
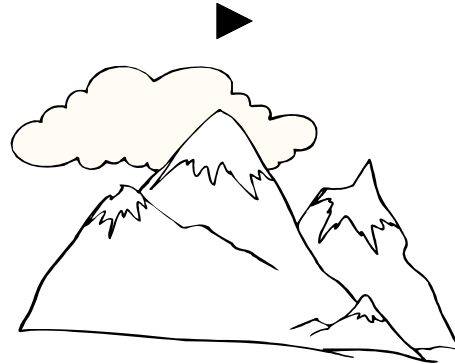
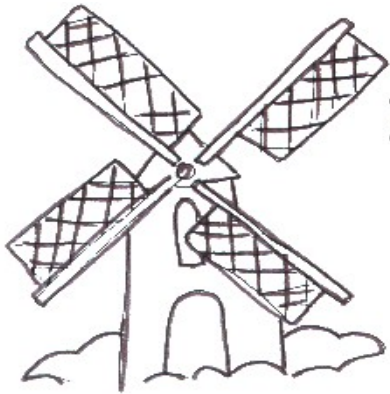

MO come ...

mo come ...

mo come ...

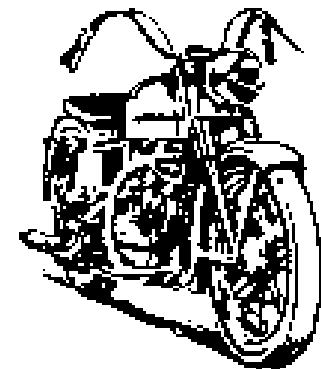

MU come ...

mu come ...

mu *come ...*

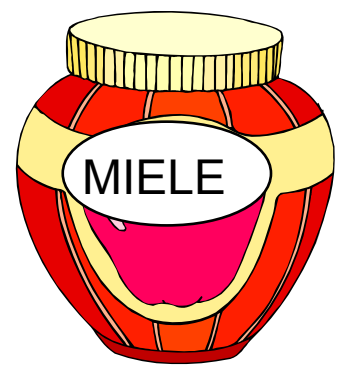
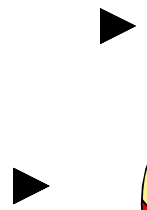
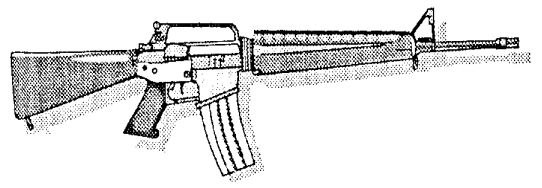

MI come ...

mi come ...

mi *come ...*

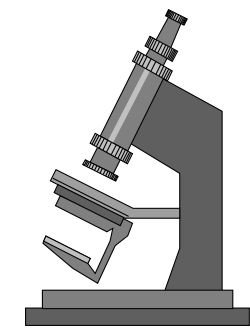
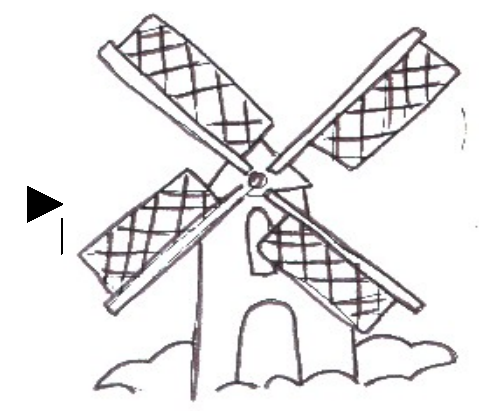

NA na *na Na*

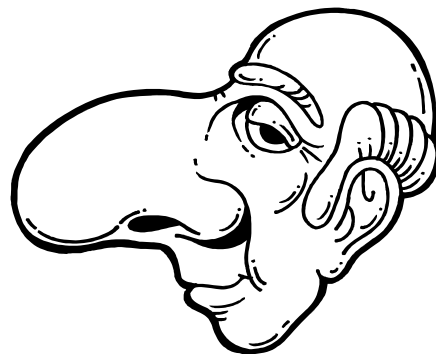

NASO

naso

naso

Naso

NA na *na Na*

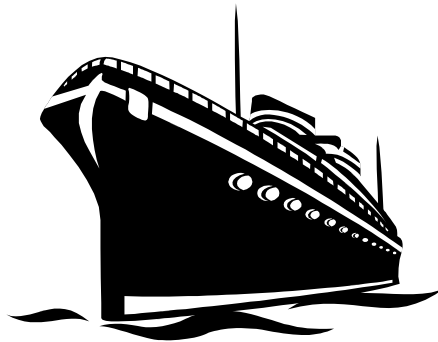

NAVE

nave

nave

Nave

NA na *na Na*



NATALE

natale

natale

Cerca le NA

NA FA MA FA NA NI NA
NU NA NI NE ZA NA MA
NA VA NA NU MA NO NI

Cerca le na

na pa na pa ma nu na no
ne na no na la na ni na
na nu la na fa ma no na

Cerca le *na*

na ne va na ni ga na ta

na ni na ne no na ga na

ne na ma la na va ni na

Cerca le *Na*

La Na Ni Na Ma Ni Pa Na

Na Ma Na Ni Na Ta Ne Na

Ne Na Ga Na Nu Ne Na Sa

Leggi

NA

Na

NA

na

NA

an

an

an

an

an

na

na

Na

na

na

an

An

an

an

an

A NA

e na

E NA

I NA

O NA

u na

a na

i na

e na

i na

o na

u na

O na

A NA

e na

i na

O na

u na

u na

a na¹⁰¹

Leggi

La nave

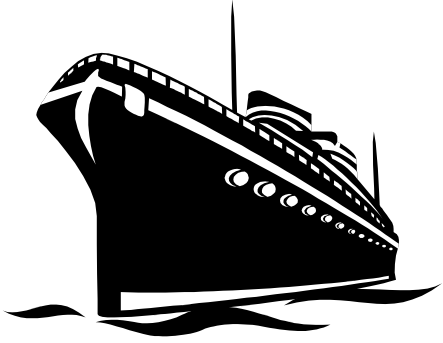

Il naso

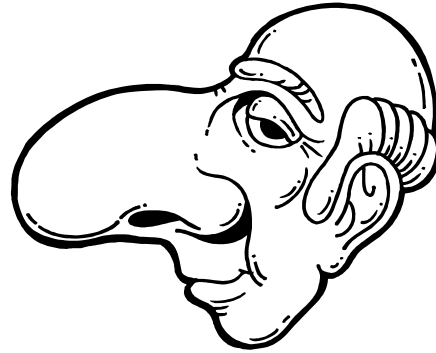

La rana



La penna



La luna

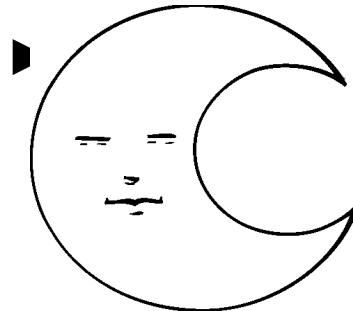

La campana



Leggi

La vanga

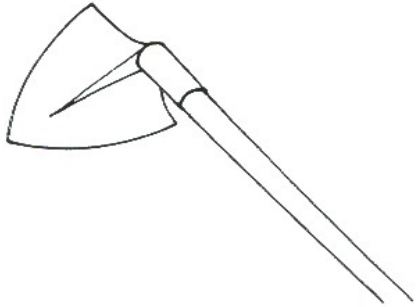

La balena



Il banco

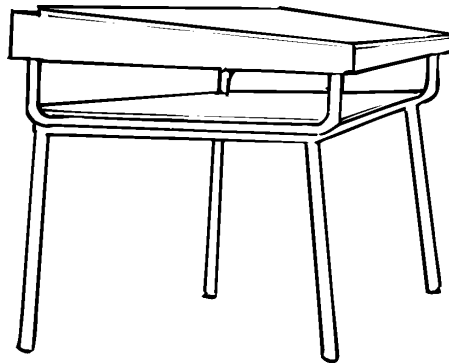

Nadia



L'elefante



La renna



Leggi

La nave naviga

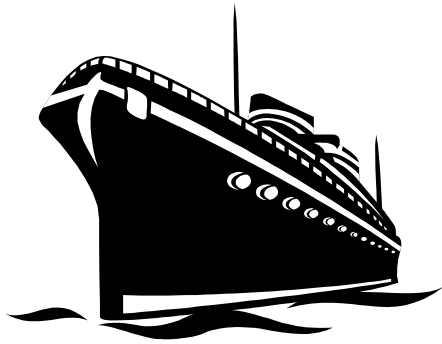

La rana salta

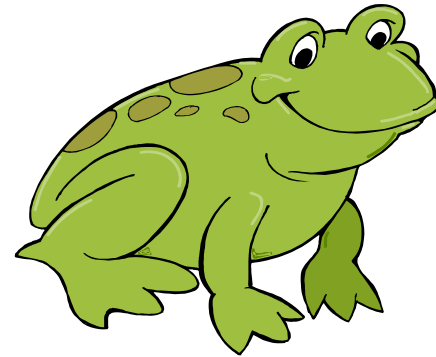

Il naso è buffo

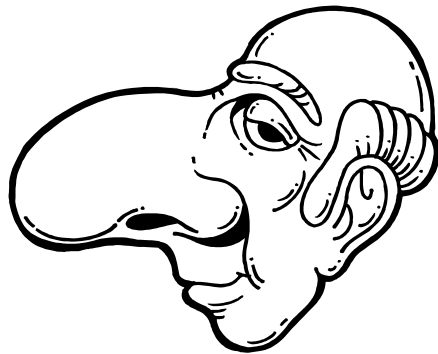

L' albero di Natale



leggi e associa

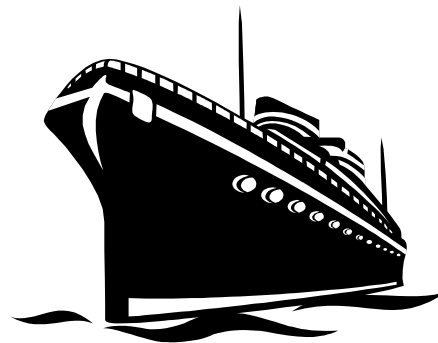
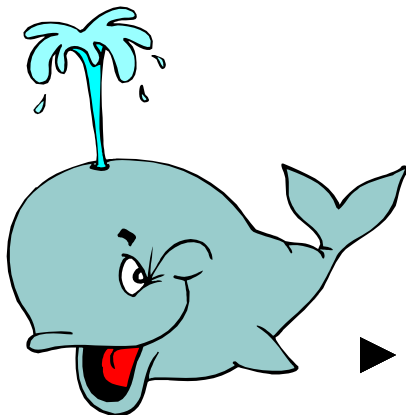
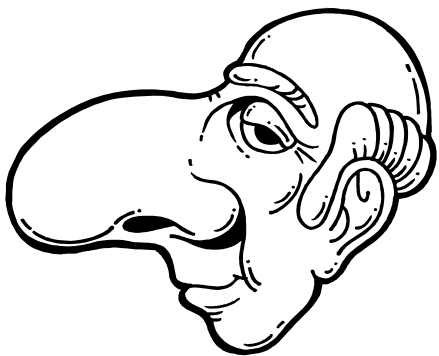

Il naso

La nave

L' elefante

La balena

Leggi

Na mu

na mo

Na mi

Na mu

Na mi

na me

ma na

Na mo

Na gu

NA GO

gi na

na ge

O na

E mu

O na

O mi

I na

u na

O mo

u me

o na

a go

a gu

i ma

O na

a gi

i na

NA come ...

na come...

na come ...

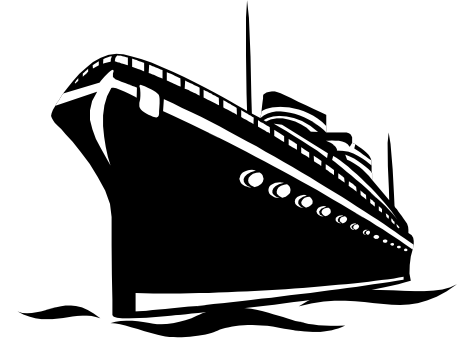
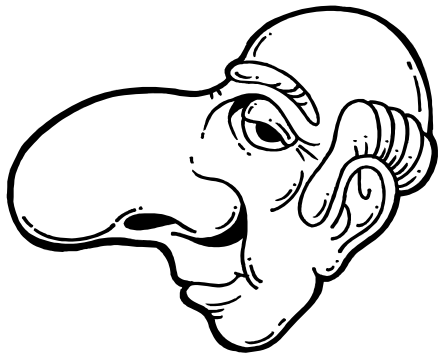

NA come ...

na come ...

na come ...

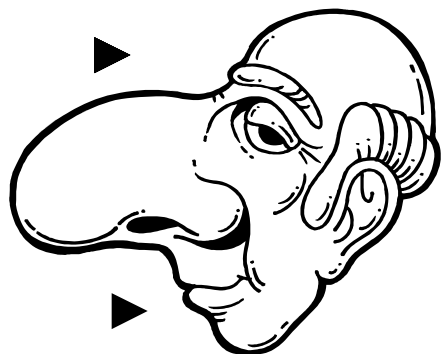
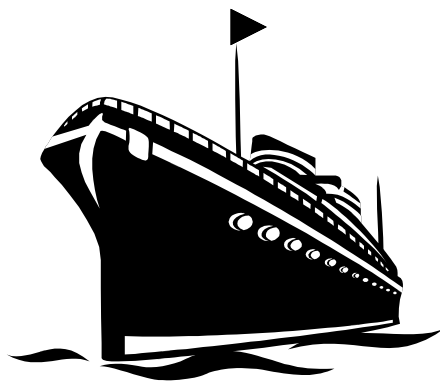
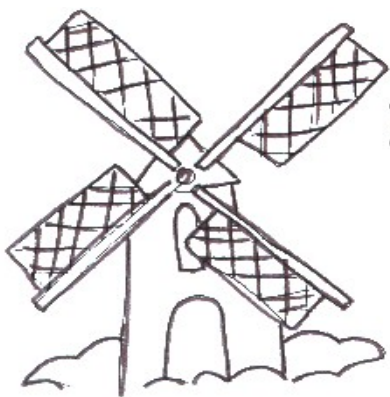

MU come ...

mu come ...

mu come ...



NA come ...

na come ...

na come ...

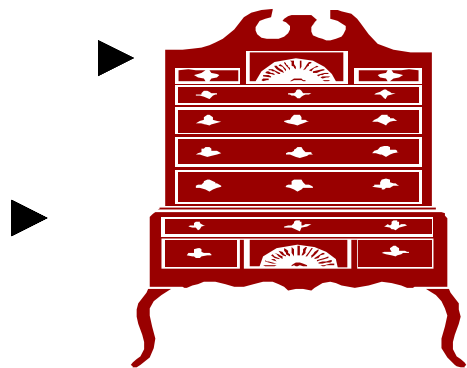
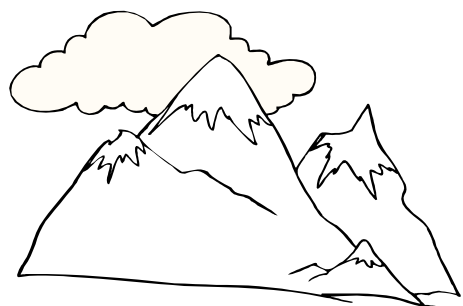

MO come ...

mo come ...

mo come ...

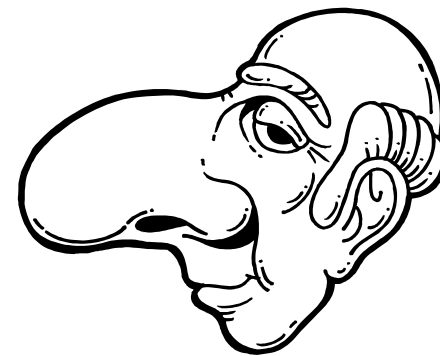
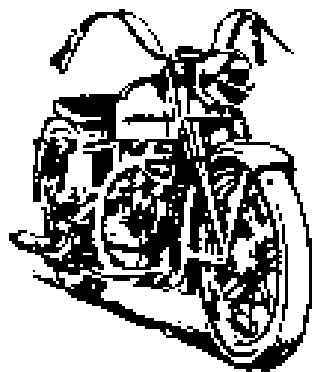
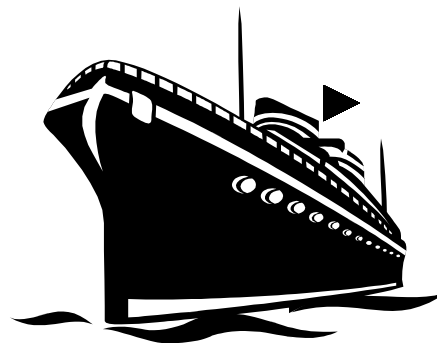

NE ne ne Ne



NERO
nero

nero

Nero

NE ne ne Ne



NEVE
neve

neve

Neve

NE ne ne Ne

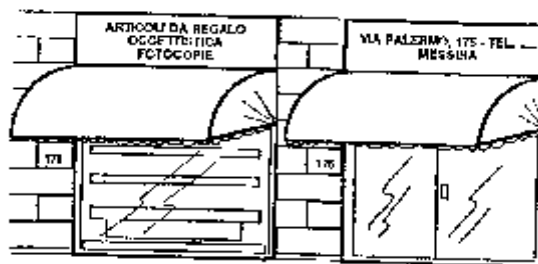

NEGOZI
negozi

negozi

Cerca le **NE**

NE NA ME NO NE TE NE
NU NE NI VE NA NE ME
NE NA NO GE ME FE NE

Cerca le **ne**

ne pe ne na me nu ne na
pe ne no ne le ne ni ne
ne nu na ne fe me ce ne

Cerca le *ne*

ne me na ne ni na ne nu
ne ve ne ve no ne ge ne
ce ne na le ne ve no ne

Cerca le *Ne*

Ni Ne Me No No Ne Le Ne
Ne Me Ne Ge Ne Na Ce Ne
Be Ne Na Ne Nu Me Ne Na

Leggi

NE

Ne

NE

ne

NE

en

en

en

en

en

ne

ne

Ne

ne

ne

en

En

en

en

en

A NE

e ne

E NE

I NE

O NE

u ne

a ne

i ne

e ne

i ne

o ne

u ne

O ne

A NE

e ne

i ne

O ne

u ne

u ne

a ne

Leggi

La neve



Il neonato



Il leone



Il pane

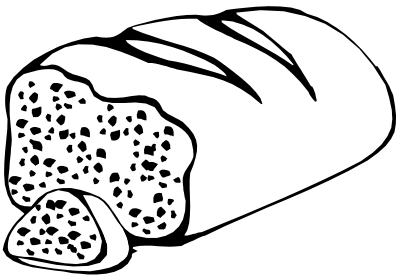

Il cane



Biancaneve



Leggi

La nebbia



Il cinema



Le rane

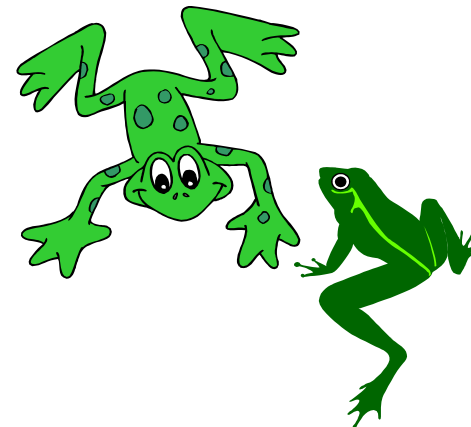

Le banane

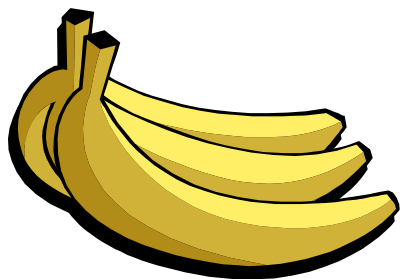

Il nemico



La fune

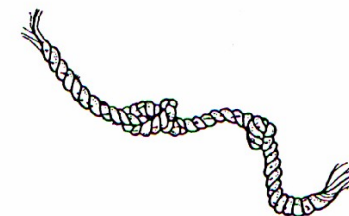

Leggi

La neve è bianca



Il cane corre



Il pane è caldo

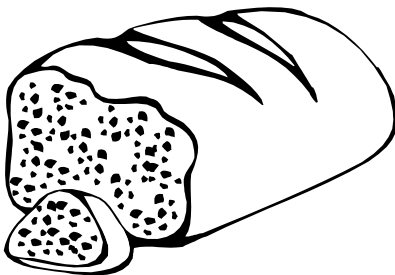

La nebbia è fitta



leggi e associa

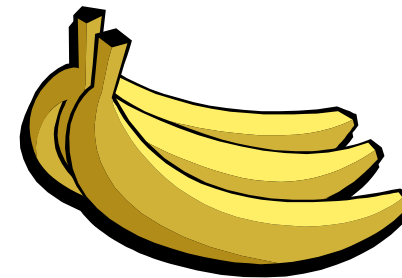

Le banane

Il neonato

Il leone

Il cane

Leggi

<i>Ne na</i>	ne mu	NE MO	<i>Ne na</i>
Ne mu	<i>ne mo</i>	mi ne	ne me
<i>Ne ma</i>	NE GU	<i>Go ne</i>	ne gi

O ne	E NA	O ne	<i>O mu</i>	I ne
<i>u ne</i>	<i>O mo</i>	u mi	o ne	a me
<i>a ne</i>	i ma	<i>O ne</i>	a gu	i go

NE come ...
ne come...

ne *come ...*

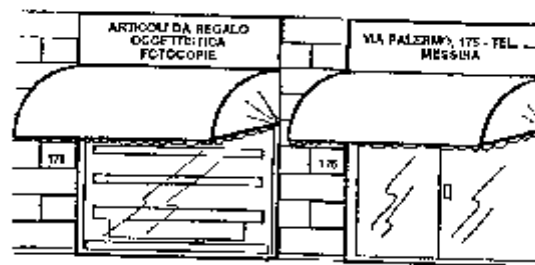

NE come ...

ne come ...

ne come ...

NA come ...

na come ...

na come ...

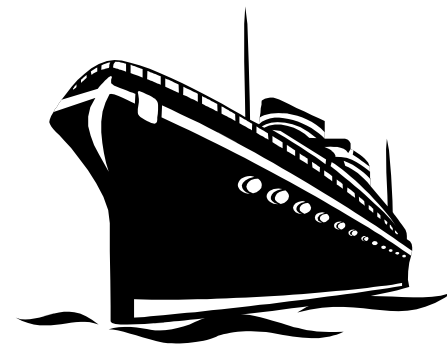
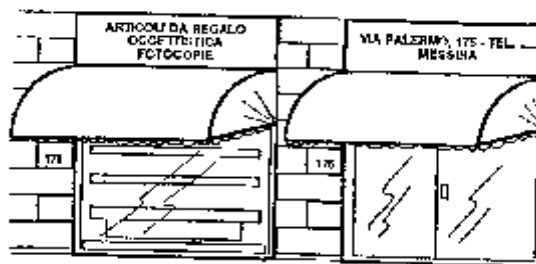
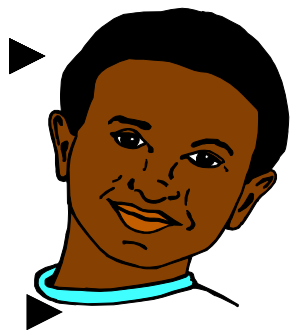
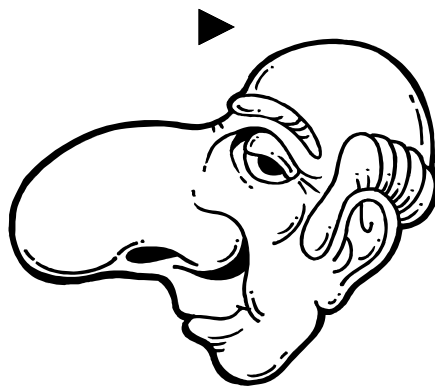

NE come ...

ne come ...

ne come ...

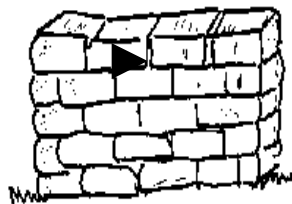
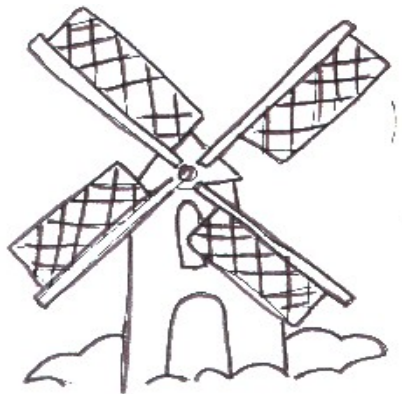

MU come ...

mu come ...

mu come ...

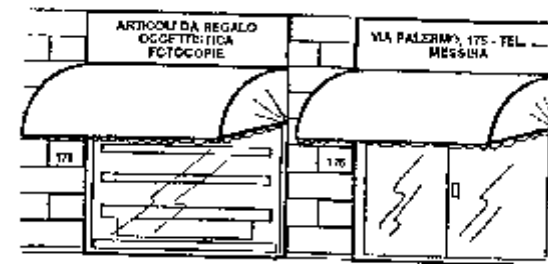

NI ni ni Ni



NIDO

nido

nido

Nido

NI ni ni Ni



NIPOTINI

nipotini

nipotini

Nipotini

NI ni ni Ni

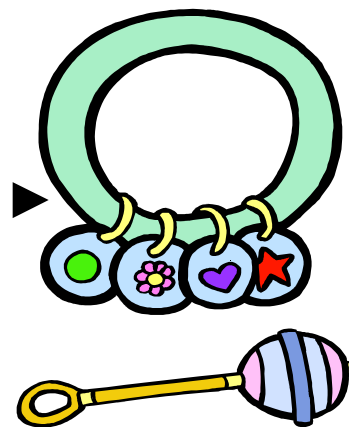

NINNOLI

ninnoli

ninnoli

Ninnoli 122

Cerca le NI

NI FI NA NO NI NE NI
TI NI LI NI NA NI MA
NI VI NU GI NO FI NE

Cerca le ni

ni ne ni na mi ci ni na
ne ni fi ni no nu li ni
ni nu li ni fi ni ci ni

Cerca le *ni*

ni ne na ni vi ci ni nu

ni vi ni ne no ni na ni

ci ni mi li ni na li ni

Cerca le *Ni*

Na Ni Vi Ni Ne Ri Pi Ni

Ni Na Ni No Ni Ti Ne Ni

Bi Ni Na Ni Nu Mi Ni Si

Leggi

NI

Ni

NI

ni

NI

in

in

in

In

in

Ni

ni

Ni

ni

ni

in

In

in

In

in

A NI

e ni

E NI

I NI

O NI

u ni

a ni

i ni

e ni

i ni

o ni

u ni

O ni

A NI

e ni

i ni

O ni

u ni

u ni

a ni

Leggi

Il nido



I nipotini



I ninnoli

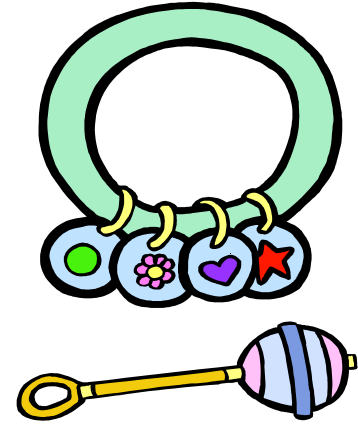

Nina



I leoni

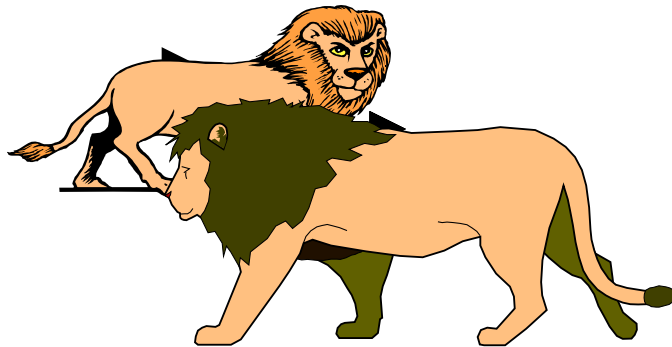

Daniela



Leggi

I cavallini

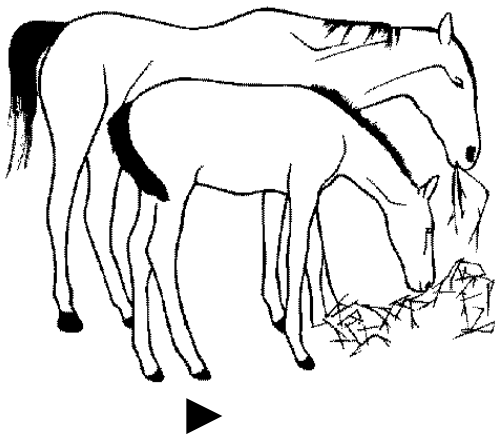

I pini



I gabbiani

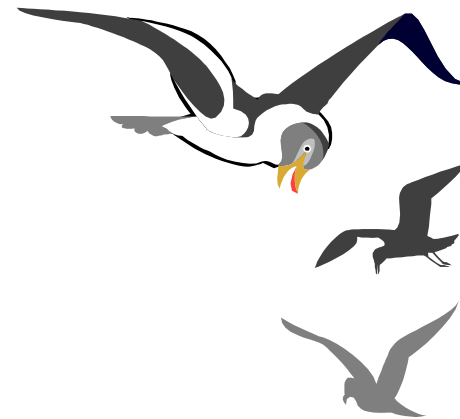

I lettini

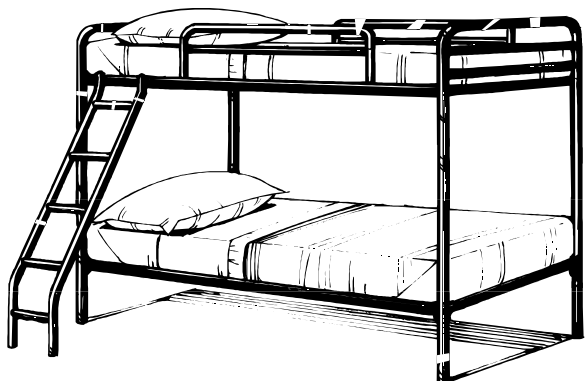

Il fenicottero

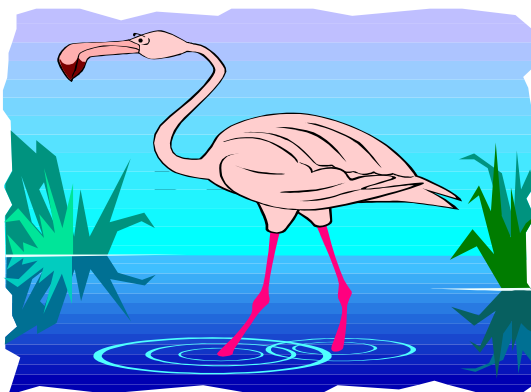

La tanica

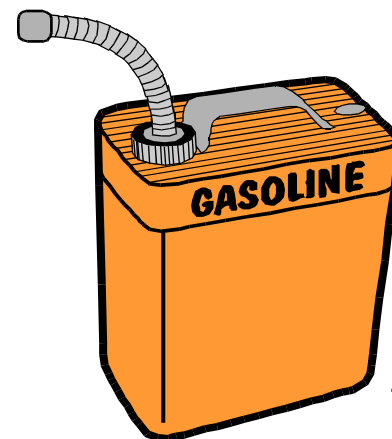

Leggi

Nicola gioca



Il fenicottero è rosa

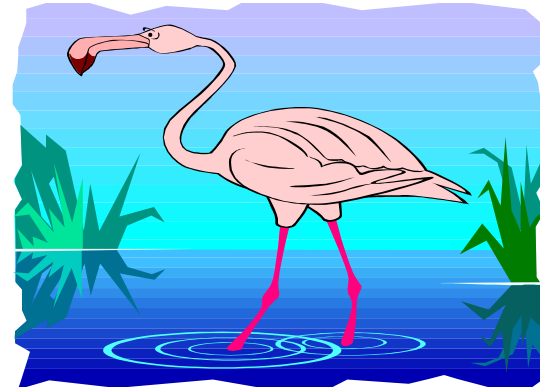

Il nido dei gabbiani



I sette nani



leggi e associa

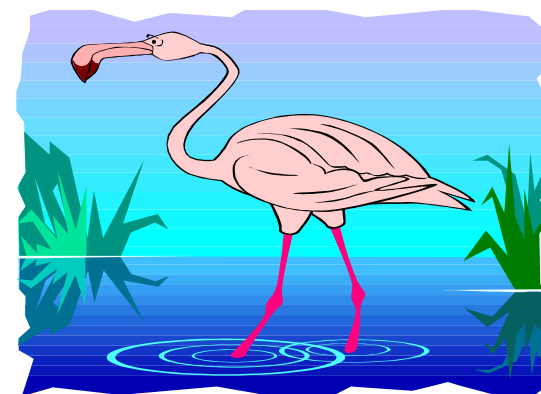
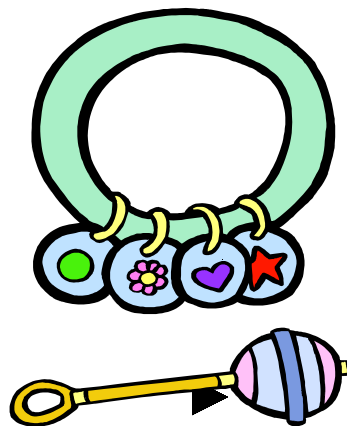
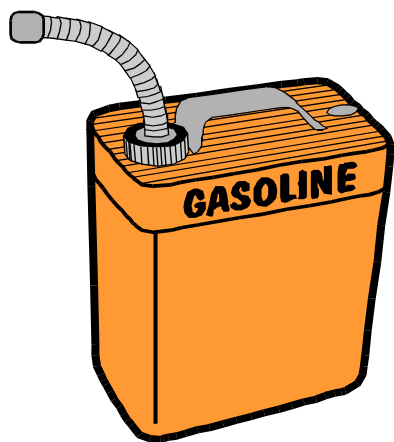

Nina

Il fenicottero

La tanica

I ninnoli

Leggi

Ni ne

ni na

Ni ne

Ni mu

Ni na

ni mu

mo ni

Mi ni

Ni me

NI MA

go ni

ni gu

O ni

E NE

O ma

O ni

I NA

u ni

O mu

u mo

o ni

a mi

a ni

i me

O ni

a gu

i ni

NI come ...
ni come...

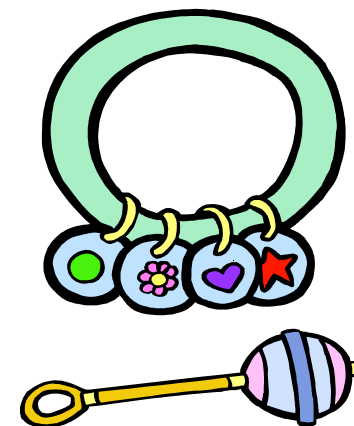

NI come ...

ni come ...

ni come ...

NE come ...

ne come ...

ne come ...

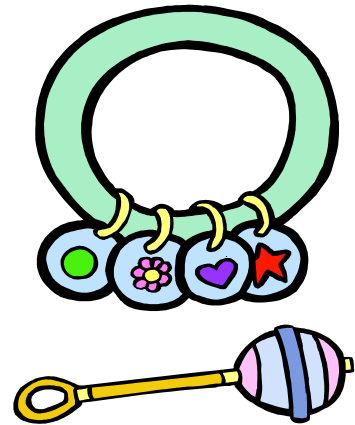
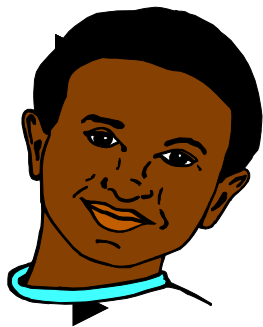
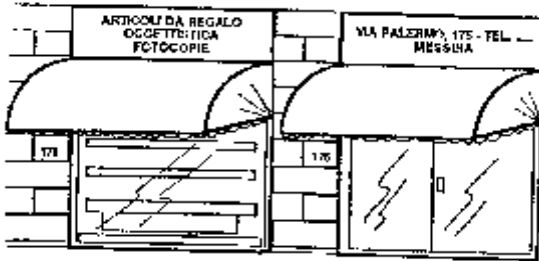

NI come ...

ni come ...

ni come ...

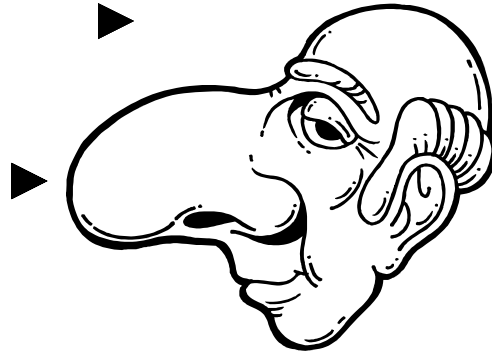
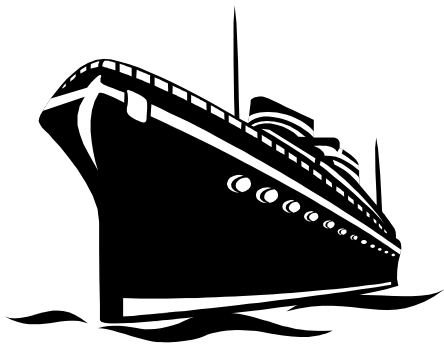

NA come ...

na come ...

na come ...

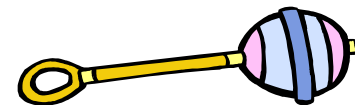
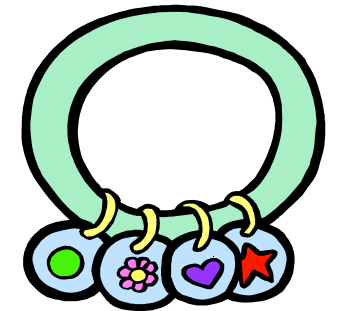

NO no *no* *No*

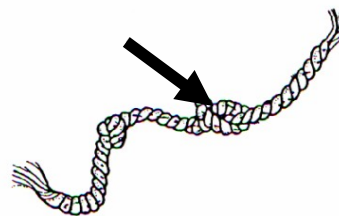

NODO
nodo
nodo

NO no *no* *No*



Nodo
NONNO
nonno
nonno
Nonno

NO no *no* *No*

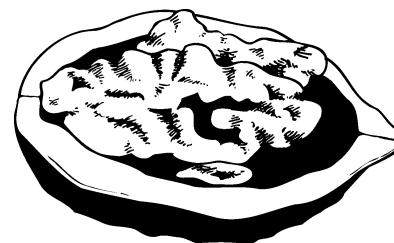

NOCE
noce
noce

Noce

Cerca le NO

NO NA MO FO NO NE NO
NU NO NI NE ZO NO MO
NO MO NO NU MO FO NA

Cerca le no

no ne no po no nu no vo
ne no fo no ne go lo no
no nu lo no na ma ni no

Cerca le *no*

no mo vo no po na no to
no ni no ne vo no na no
ne no mo lo no na ni no

Cerca le *No*

Lo No Ni No Mo Na Na No
No Mo No Ni No To Co No
Nu No Ni No Fo Mo No Na

Leggi

NO

No

NO

no

NO

on

on

on

on

on

no

no

No

no

no

on

on

on

on

on

A NO

e no

E NO

I NO

O NO

u no

a no

i no

e no

i no

o no

u no

O no

A NO

e no

i no

O no

u no

u no

a no¹³⁷

Leggi

Il nonno



Il nodo

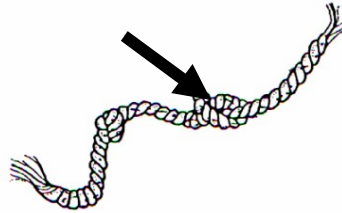

La noce

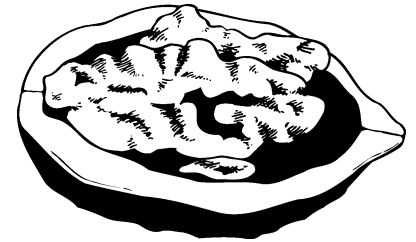

Noi



Il canarino

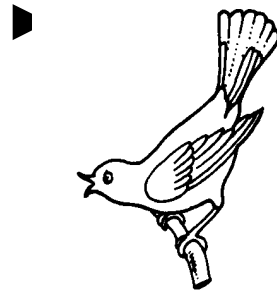

Naomi



Leggi

Il cavallino

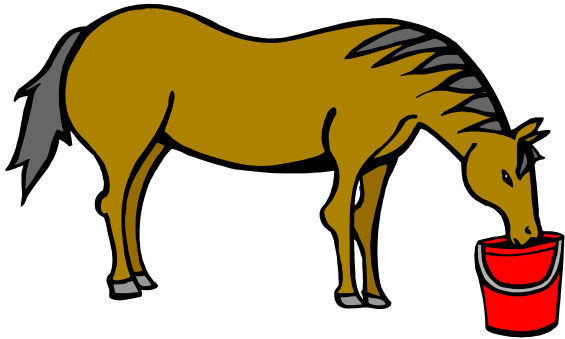

Il nano



Il pino

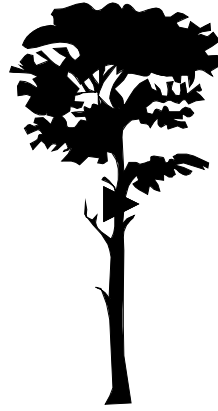

Il bambino



Il nocciolo

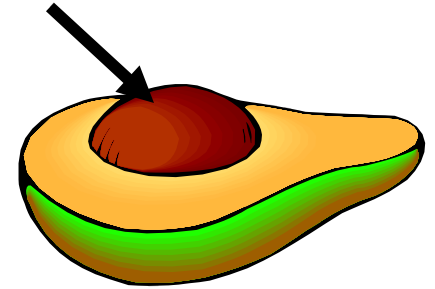

La notte



Leggi

Il nonno telefona alla nonna

Noemi gioca



La noce è buona

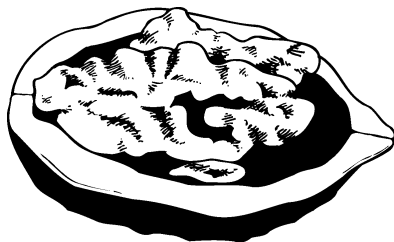

Il nano cammina



leggi e associa

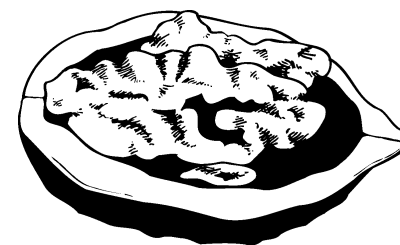
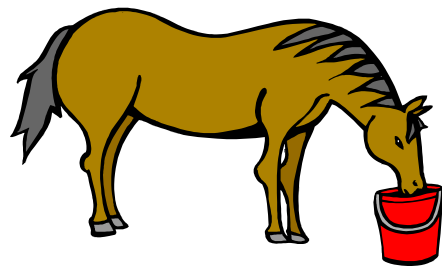

Il cavallino

Il nano

Il nonno

La noce

Leggi

cambiare

no va

~~CE~~ ~~FA~~ FO

Lo In

VA Ve

no fa

ma no

ce vi

te va

NO PO

Co no

no va

O no

E VA

O ma

O vi

I VA

u no

O cu

u va

o no

a co

a va

i li

O no

a lo

i VE

NO come ...

no come...

no

come ...

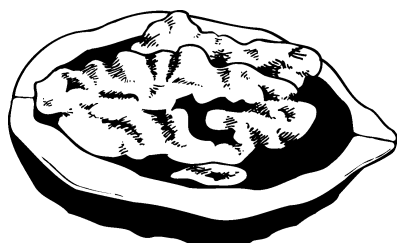
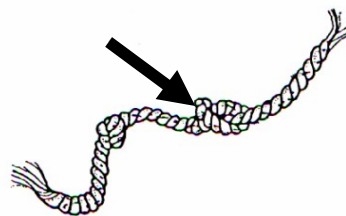

NO come ...

no come ...

no come ...

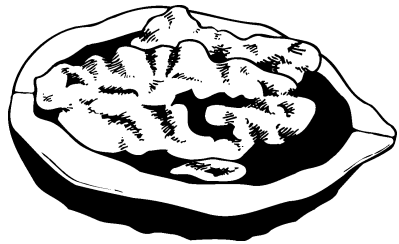
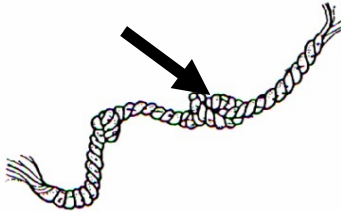

NI come ...

ni come ...

ni come ...

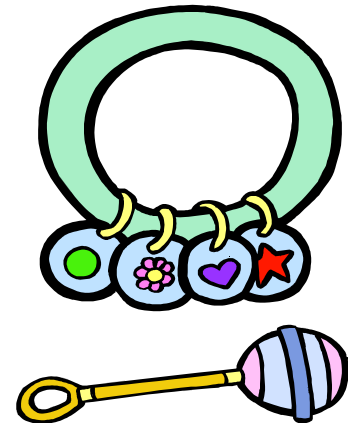
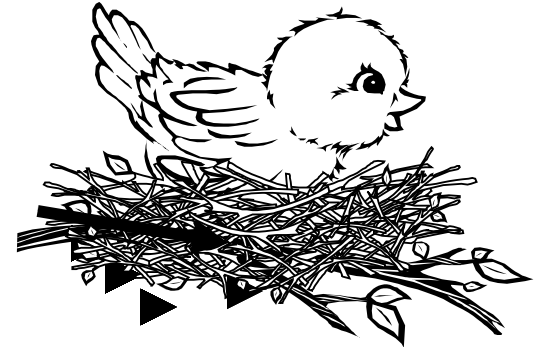

NO come ...

no come ...

no come ...

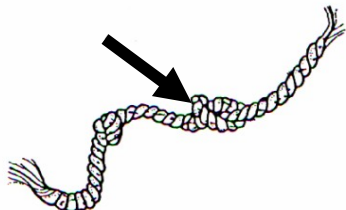
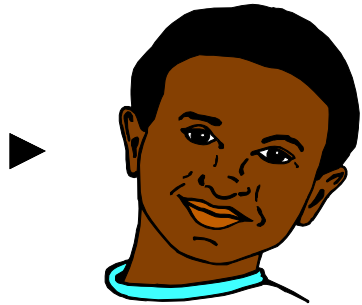

NE come ...

ne come ...

ne come ...

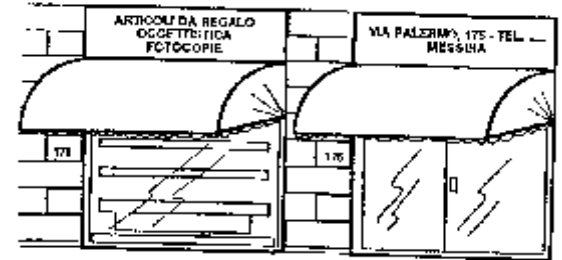

NU nu nu Nu

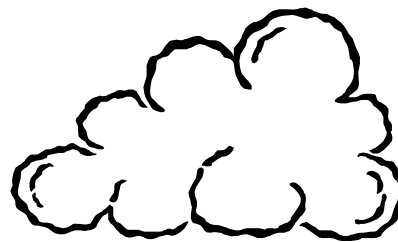

NUVOLA
nuvola

nuvola

Nuvola

NU nu nu Nu

1 3 5
2 7

NUMERI
numeri

numeri

Numeri

NU nu nu Nu

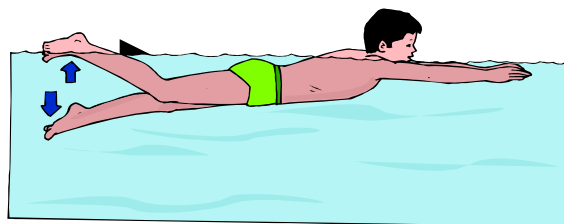

NUOTARE
nuotare

nuotare

Nuotare

Cerca le NU

NU FU NA NO NU NE LU
NU TU NU NI VU NA NU
MU NU NA NU GU NA FU

Cerca le nu

nu ne nu pu na cu nu na
pu nu fu nu no nu lu nu
nu cu na nu fu na no nu

Cerca le *nu*

nu ne vu nu ni na nu tu
nu vu nu vu no nu na nu
ne nu na lu nu vu lu nu

Cerca le *Nu*

Nu Ni Nu Na Nu Na Nu Lu
Nu Na Vu Gu Nu Na Ne Nu
Ne Nu Gu Nu Fu Mu Nu Su

Leggi

NU

Nu

NU

nu

NU

un

un

un

un

un

nu

nu

Nu

nu

nu

un

un

un

un

un

A NU

e nu

E NU

I NU

O NU

u nu

a nu

i nu

e nu

i nu

o nu

u nu

O nu

A NU

e nu

i nu

O nu

u nu

u nu

a nu

Leggi

Le nuvole

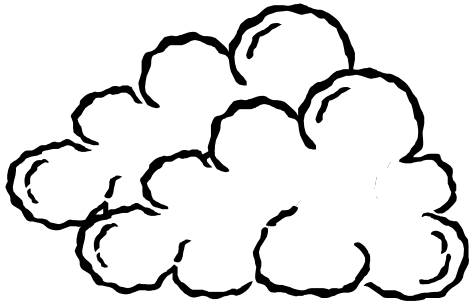

I numeri

1 3 5
2 7



L'uno

1

Nudo

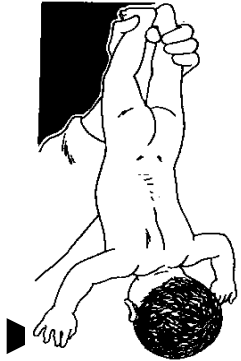

Nuota

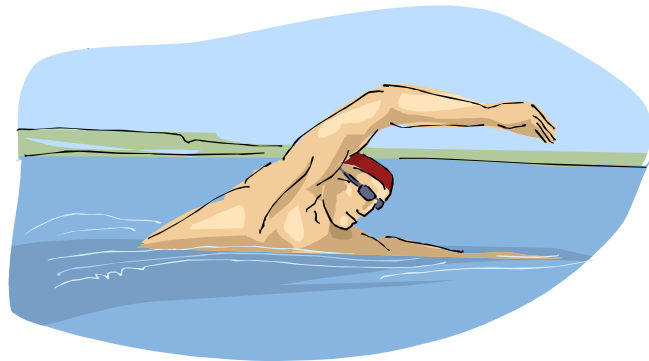

I nuvoloni

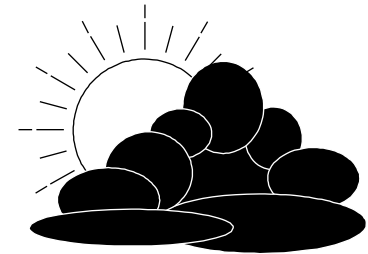

Leggi

Nuovo



La nuca

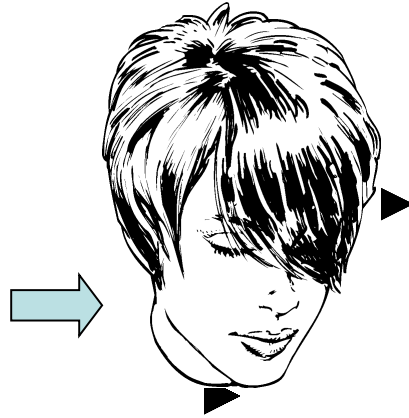

Nubile

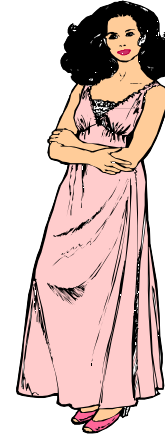

Nuvoloso



La nuora



La nube



Leggi

Nino impara i numeri



È il numero uno

1

Nino nuota nudo

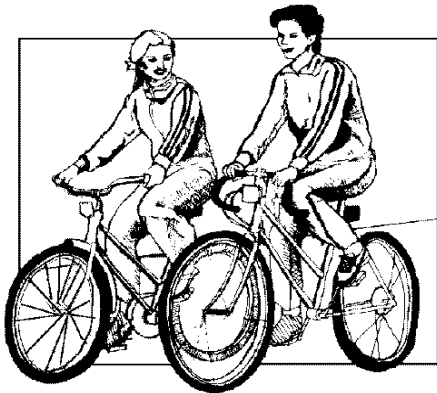
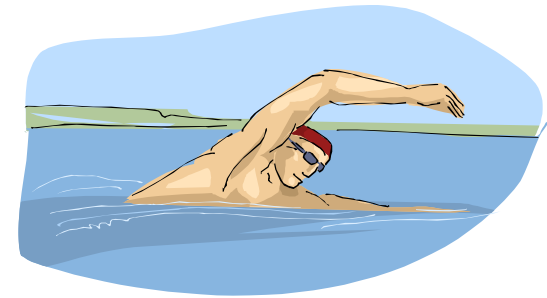

▶
Il tuo pantalone nuovo è
lungo, il mio è corto

leggi e associa



1 3 5
2 7



La nuvola

I numeri

La nube

La nuca

Leggi

Nu no

nu ni

Nu no

Nu ne

Nu ni

nu ne

na nu

Nu mu

Nu mo

NU MI

me nu

nu ma

O nu

E NO

O ni

O ne

I nu

u nu

O na

u mu

o nu

a mo

a nu

i mi

O nu

a me

i nu

NU come ...

nu come...

nu *come ...*

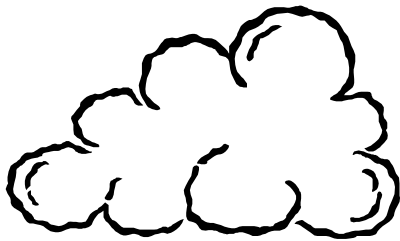

1 3 5
2 7

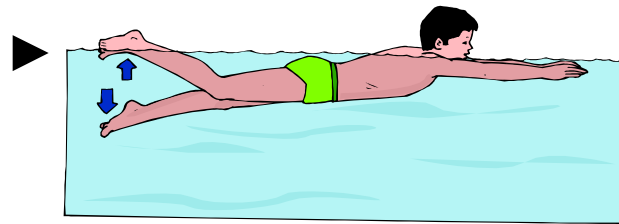

NU come ...

nu come ...

nu come ...

NO come ...

no come ...

no come ...

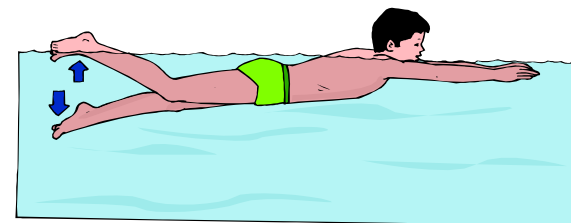
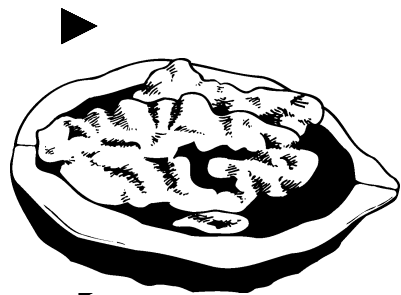
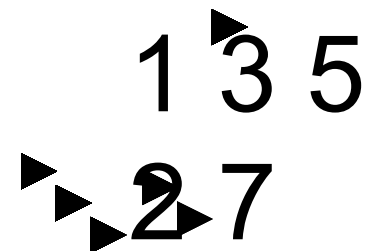
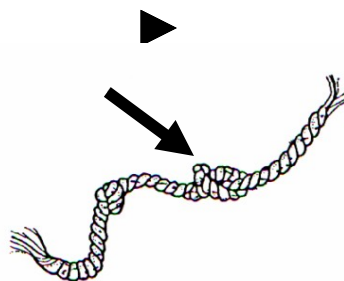

NU come ...

nu come ...

nu come ...

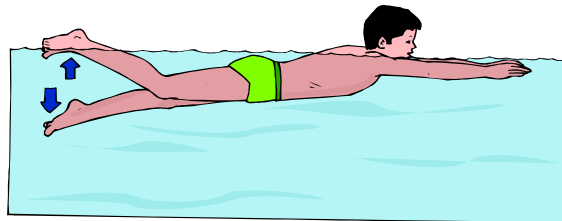
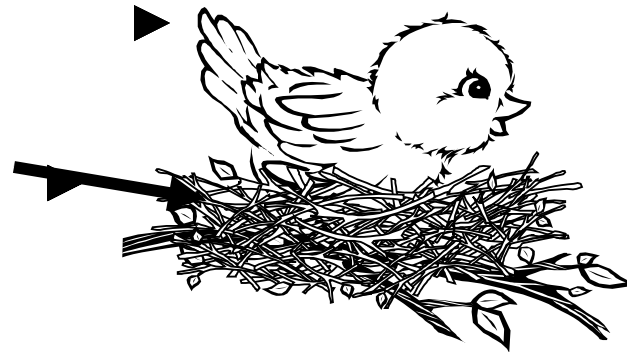

NI come ...

ni come ...

ni come ...

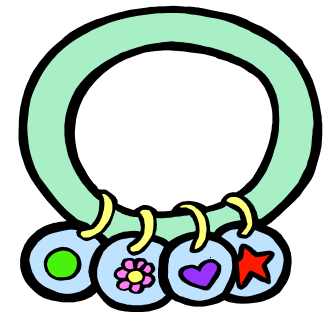
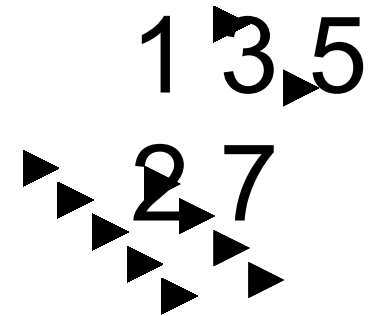

ZA za za *Za*



ZAINO

zaino

zaino

zaino

ZA za za *Za*

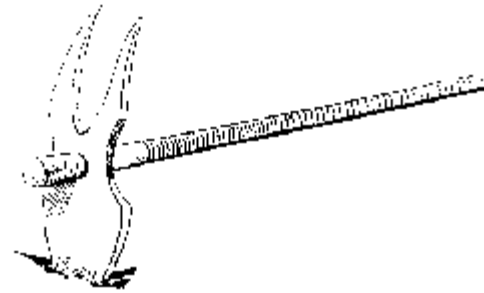

ZAPPA

zappa

zappa

Zappa

ZA za za *Za*

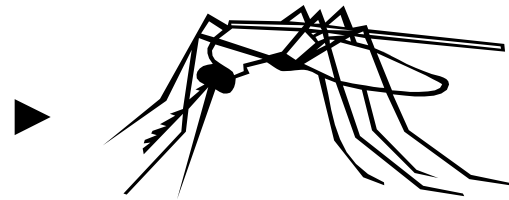

ZANZARA

zanzara

zanzara

Zanzara

Cerca le ZA

ZA FA ZE NA ZA TA ZA ZU
ZA ZU ZE ZI ZA MA ZA VA
ZA ZO ZA FA ZA BA ZI ZA

Cerca le za

za ze za pa ma zu za va
ze za zo za zo za zi za
za zu la za fa ma ca za

Cerca le *za*

za ze va za zi ca za zu

za zi za ze va za ga ma

ze za ma za za zu la za

Cerca le *La*

La Li Lu La Ma La Pa La

La Ma La Lu La Ga Le La

Le La Ga La Fa Li La Lo

Leggi

ZA

La

ZA

za

ZA

az

az

az

Az

az

La

za

Za

za

Za

az

az

az

az

az

A ZA

e za

E ZA

I ZA

O ZA

u za

a za

i za

e za

i za

o za

u za

O za

A ZA

e za

i za

O za

u za

u za

a za

Leggi

La pizza

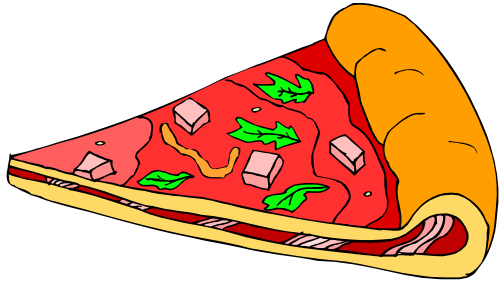

La zappa

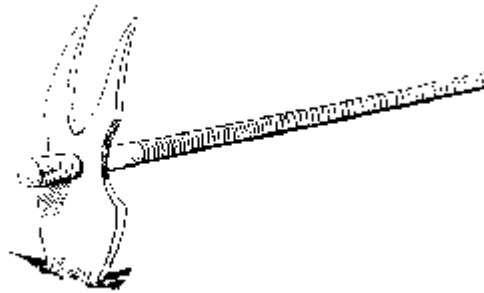

La zattera

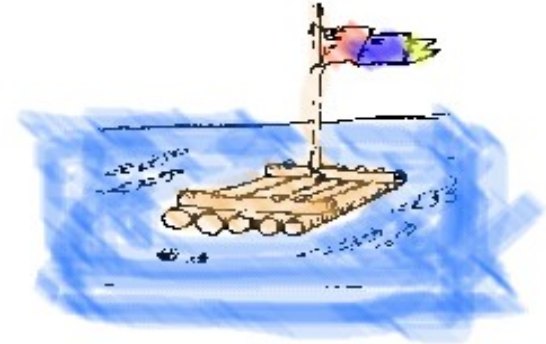

La tazza



Lo zaffiro

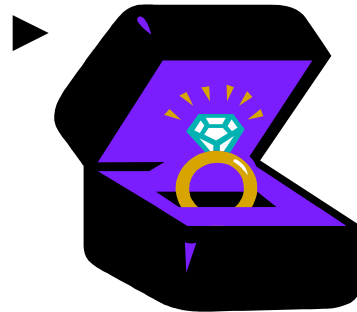

La piazza

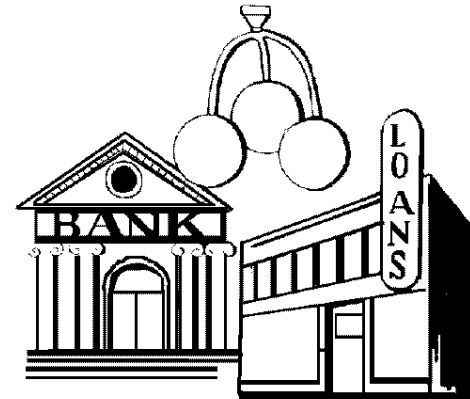

Leggi

La forza

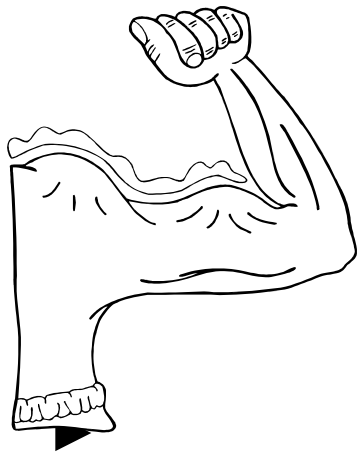

La pezza

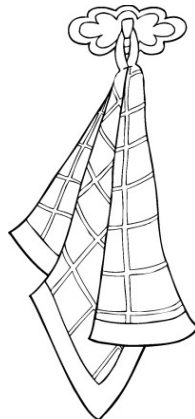

L'azalea



La zanzariera

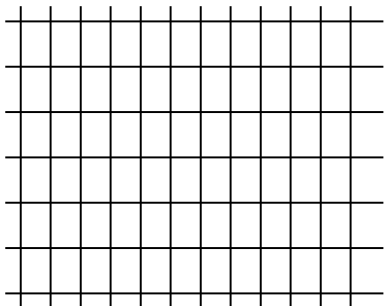

Lo zappatore



La calza



Leggi

La pizza a fette

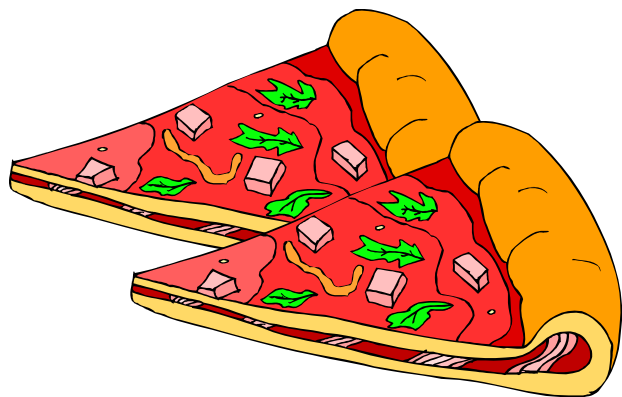

La zanzara è sulla zanzariera

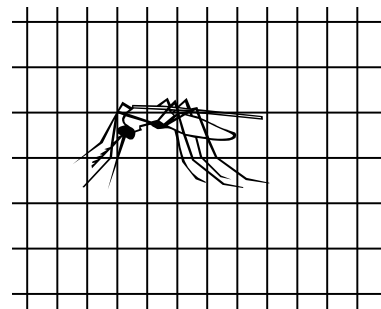

La zattera è piccola

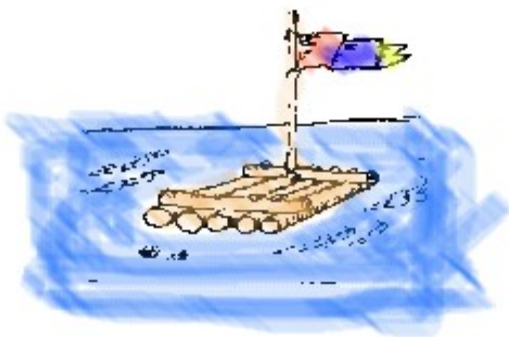

Zappa la terra



leggi e associa

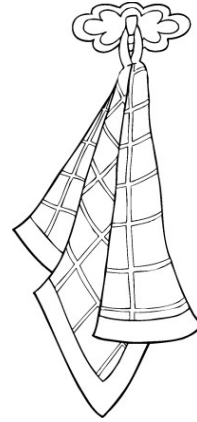
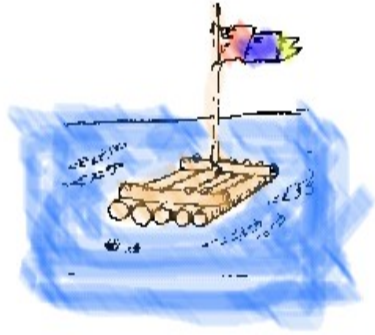

La calza

La pezza

La zattera

La tazza

Leggi

nu za

za no

ni za

Za nu

Za no

za ni

ne za

Za na

mu za

ZA MO

mi za

za me

O za

E NU

O za

O no

I NI

u za

O ne

u na

o za

a mu

a mo

i za

O za

a mi

i za

ZA come ...

za come...

za *come ...*

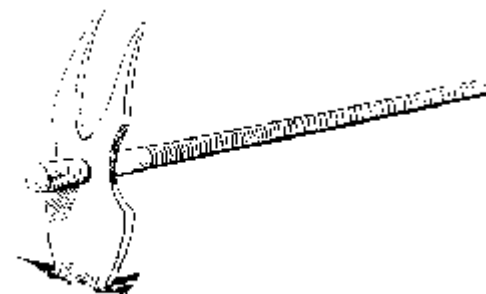
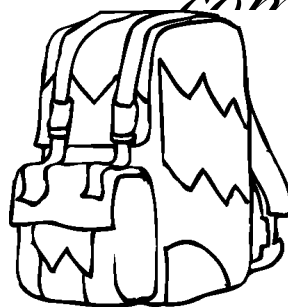

ZA come ...

za come ...

za come ...

NU come ...

nu come ...

nu come ...

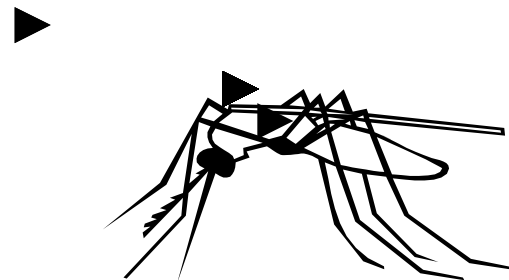
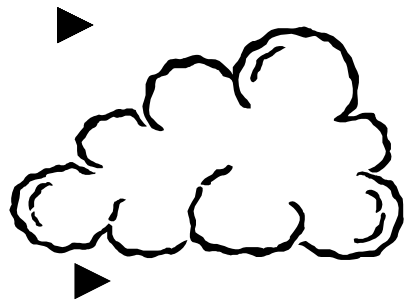
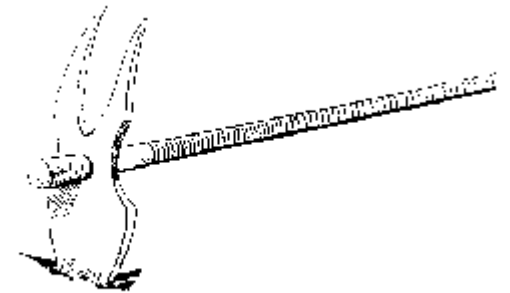
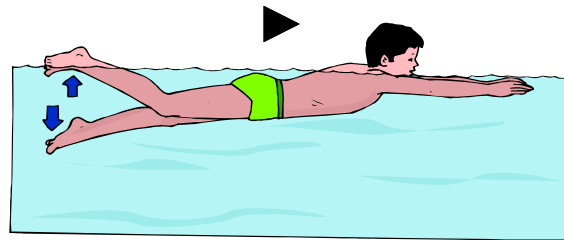
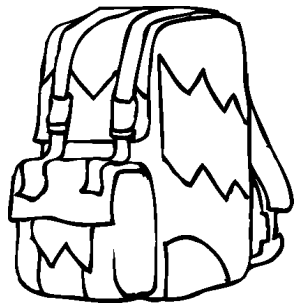

1 3 5
2 7

ZA come ...

za come ...

za come ...

NO come ...

no come ...

no come ...

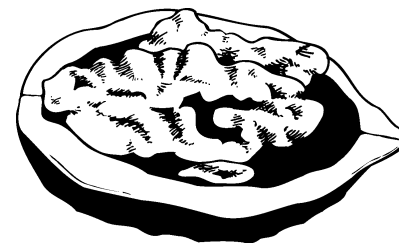
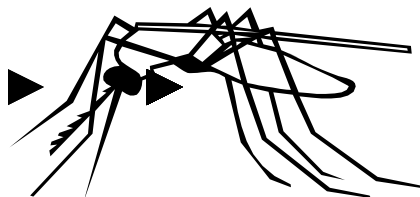
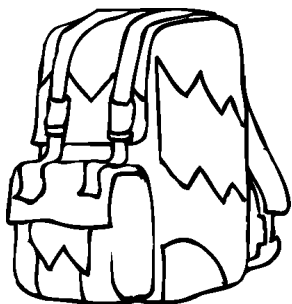
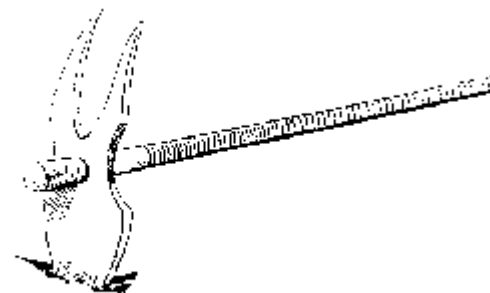
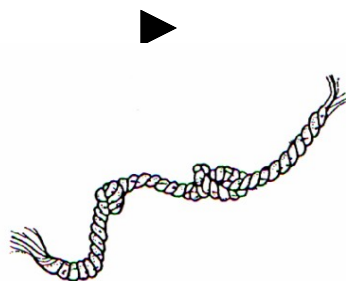
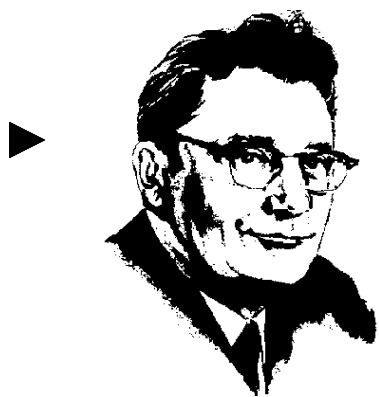

ZE ze ze Ze

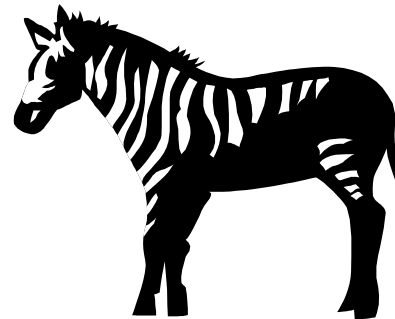

ZERO

zero

zero

zero

ZEBRA

zebra

zebra

Zebra

ZE ze ze Ze

0

ZEUS

zeus

ZE ze ze Ze

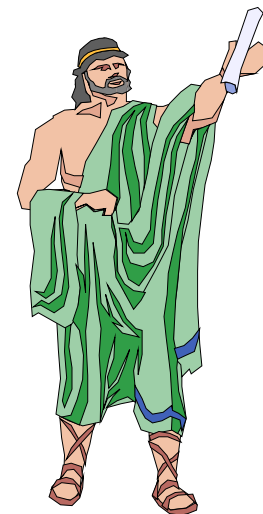

zeus

Cerca le ZE

ZE ZE ZE BE ZE TE ZE VE
ZE ZI VE ZI ZE ME ZE ZA
ZE GE ZE ZA ZE ZU ZI ZO

Cerca le ze

ze pe ze zi za zu ze ve
pe ze zo ze le ge zi ze
ze ce za ze fe ze zo ze

Cerca le *ze*

ze me za ze zi za ze zu
ze zi ze be ve ze ge ze
ce ze me za ze ve zi ze

Cerca le *Le*

Le La Le Pe Le Le Li Li
Le La Le Li Le Fe Ce Le
Be Le La Le Fe Me Le La

Leggi

ZE

Ze

ZE

ze

ZE

ez

ez

ez

Ez

ez

ze

ze

Ze

ze

ze

ez

ez

ez

ez

ez

A ZE

e ze

E ZE

I ZE

O ZE

u ze

a ze

i ze

e ze

i ze

o ze

u ze

O ze

A ZE

e ze

i ze

O ze

u ze

u ze

a ze¹⁷³

Leggi

Zeus



La zecca



Lo zero

0

La zeta

Z

La pizzetta

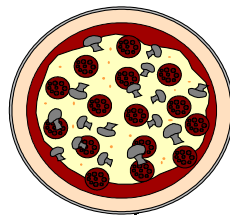

La zeppa



Leggi

Le pezze

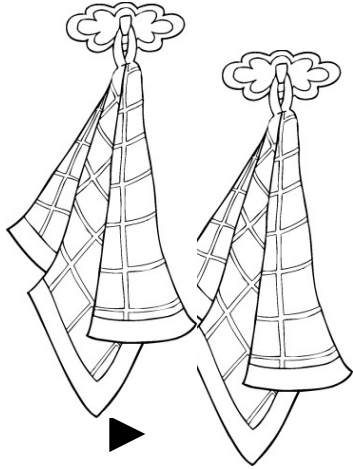

Le pizze

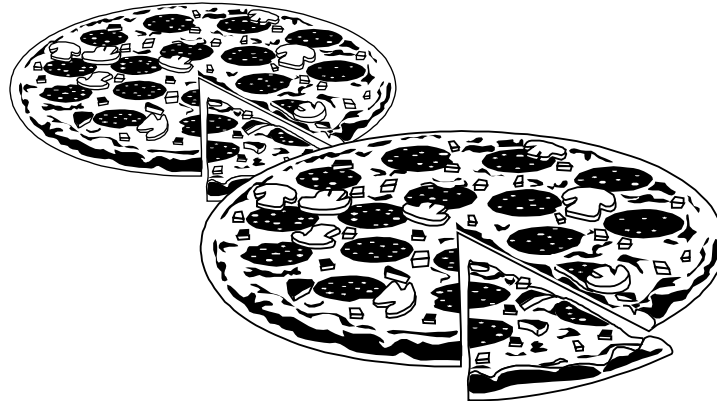

Le tazze

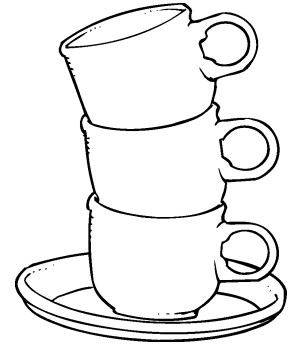

Le carrozze

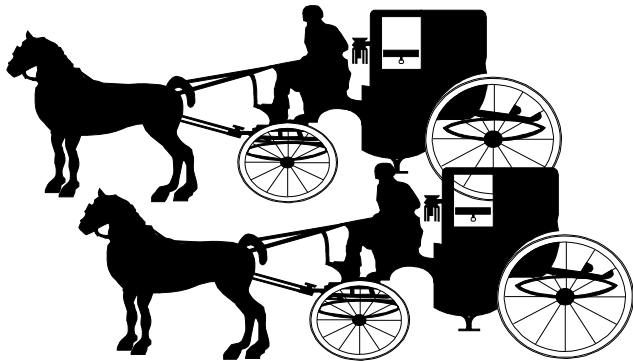

Le cozze



Le calze

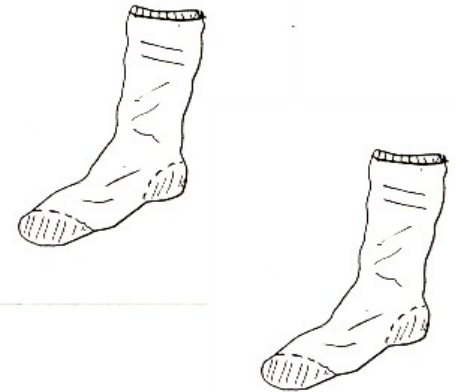

Leggi

Ninetta ha le calze bucate



È piacevole il soffio dello zefiro.



Le pizze sono a fette

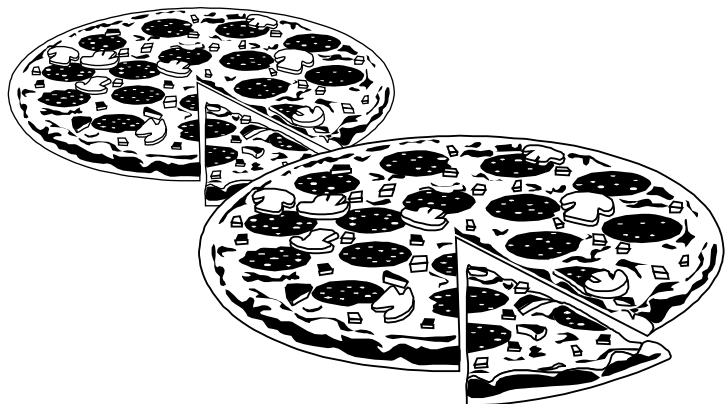

Le tazze sono vuote

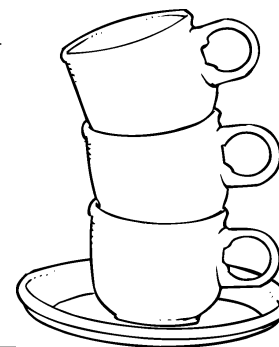

leggi e associa



0



Le cozze

Lo zero

Le calze

Le tazze

Leggi

Ze za

ze nu

Ze za

Ze nu

Ze no

no ze

ni ze

ze ne

Ze na

Ze mu

mo ze

Ze mi

O ze

E NU

O ze

O no

I ZE

u mo

O ni

u ne

o ze

a za

a ze

i na

O ze

a mu

i ze

ZE come ...

ze come...

ze come ...

0

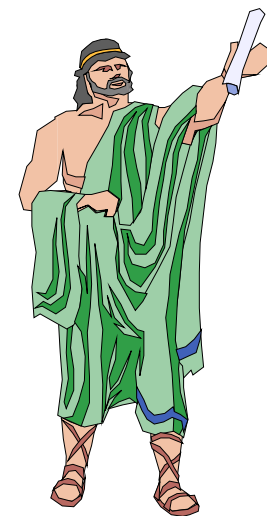
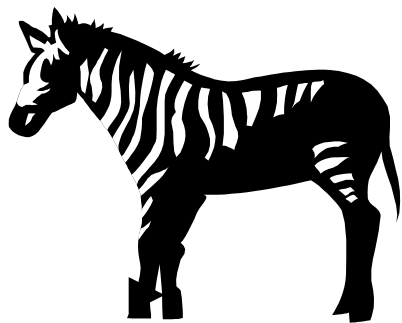

ZE come ...

ze come ...

ze come ...

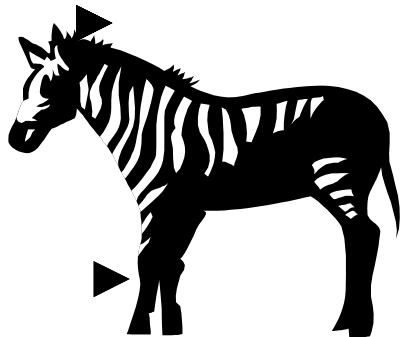
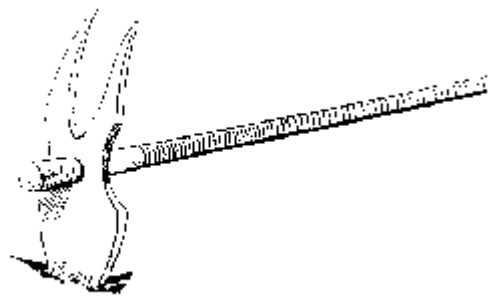
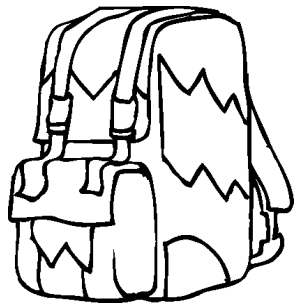

ZA come ...

za come ...

za come ...

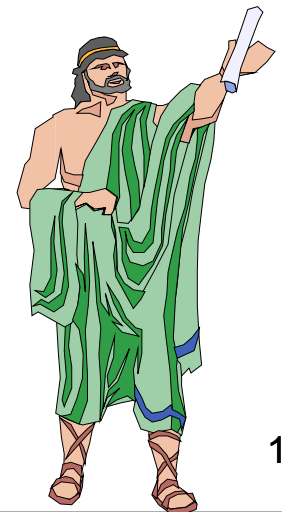
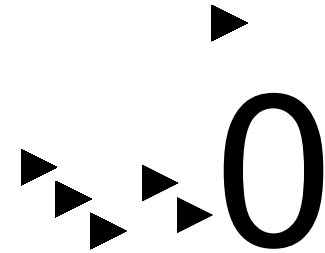

ZE come ...

ze come ...

ze come ...

0

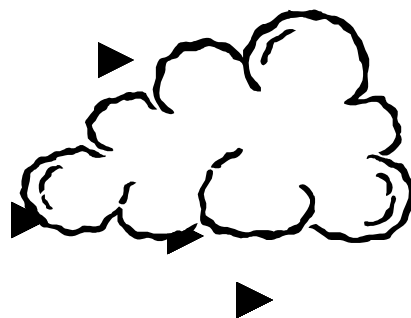
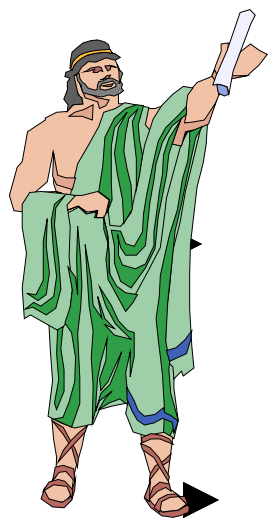

Nu come ...

nu come ...

nu come ...

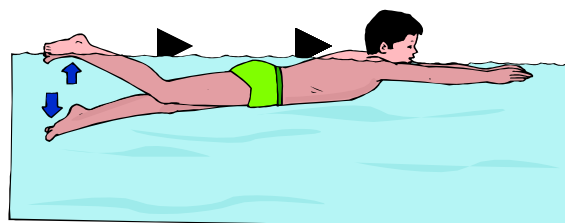
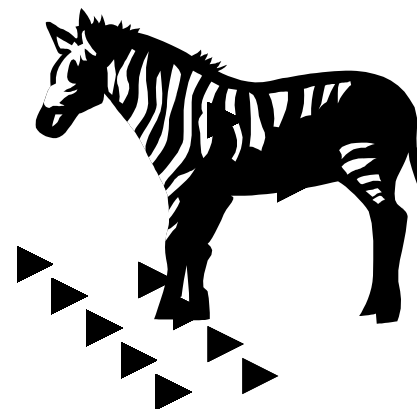

1 3 5

2 7

ZI zi *zi Zi*



ZIA

zia

zia

zia

ZI zi *zi Zi*



ZIO

zio

zio

Zio

ZI zi *zi Zi*



ZINGARA

zingara

zingara

Zingara

Cerca le

ZI

ZI	FI	MI	ZO	ZI	ZE	ZI	ZU
ZU	ZI	VI	ZE	ZI	ZI	ZA	ZI
VI	ZI	GI	ZA	FI	ZI	ZA	ZI

Cerca le

zi

zi	pi	zi	za	mi	zu	zi	vi
ze	zi	zo	zi	li	zu	zi	zi
zi	ci	li	zi	za	mi	zo	zi

Cerca le *zi*

zi ze vi zi li za zi zu
zi vi zi ze zo zi gi zi
ze zi mi li zi za li zi

Cerca le *Li*

Vi Li La Li La Li Li Pi
Li Lu Li Lo Li Fi Le Li
Le Li Gi Li Lu Mi Li Si

Leggi

ZI

Zi

ZI

zi

ZI

iz

iz

iz

iz

iz

Zi

zi

Zi

zi

zi

iz

Iz

iz

iz

iz

A ZI

e zi

E ZI

I ZI

O ZI

u zi

a zi

i zi

e zi

i zi

o zi

u zi

O zi

A ZI

e zi

i zi

O zi

u zi

u zi

a zi

Leggi

La zia



Lo zio



Lo zibibbo

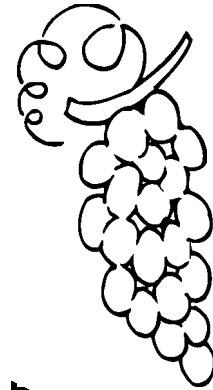

Ezio



Zitto!

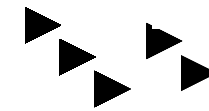
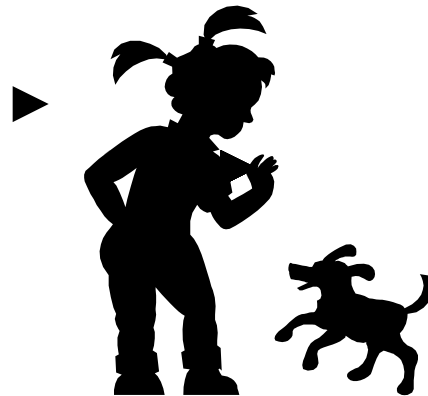

Ozio



Leggi

I pozzi

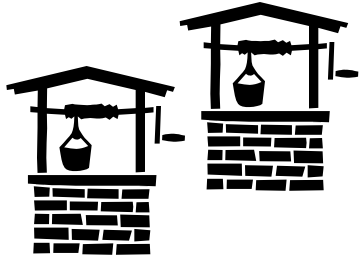

I pezzi

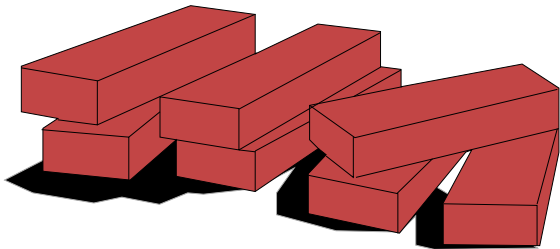

La zitella

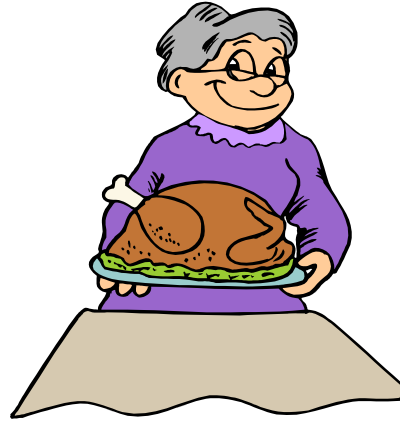

Il Lazio



Le tazzine

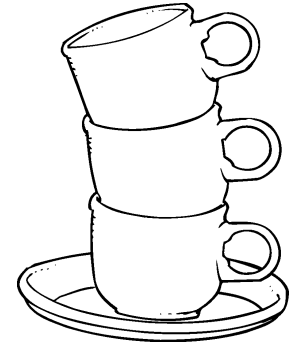

I calzini

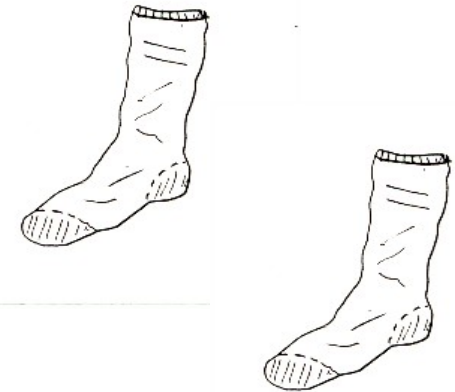

Leggi

Il negozio della zia

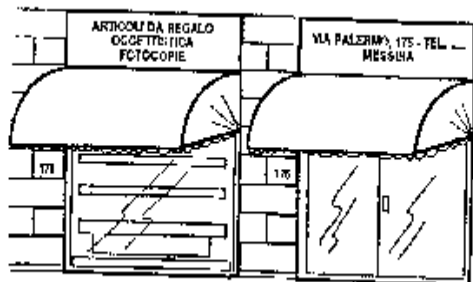

Il medico cura il paziente



Lo zio e la zia sono buoni con Nino



Le tazzine sono pulite

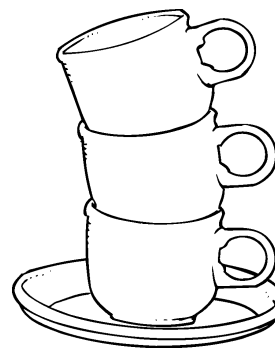

leggi e associa

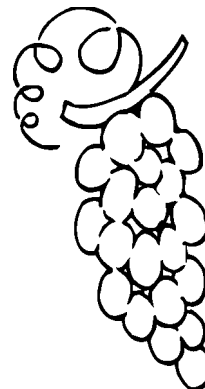

Zitto!

Lo zibibbo

La zia

Lo zio

Leggi

Li za

zi ze

Zi za

Li ze

Zi nu

zi na

nu zi

No zi

Li ni

ZI NA

ne zi

zi mu

O zi

E ZE

A zi

O za

I zi

u zi

E nu

u no

o zi

a ni

a ne

i na

O zi

a mu

i zi

ZI come ...

zi come...

zi come ...



ZI come ...

zi come ...

zi come ...

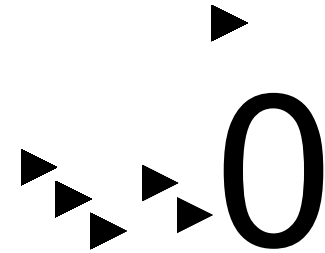
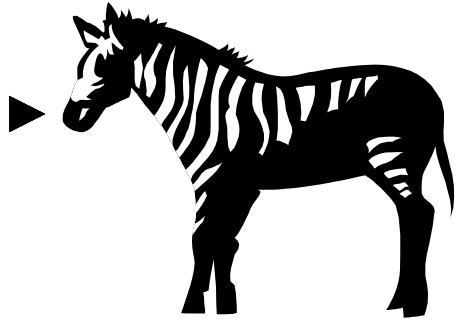

ZE come ...

ze come ...

ze come ...

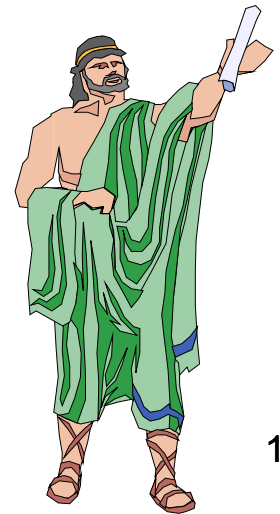

ZI come ...

zi come ...

zi come ...

ZA come ...

za come ...

za come ...

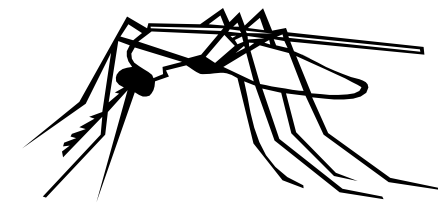
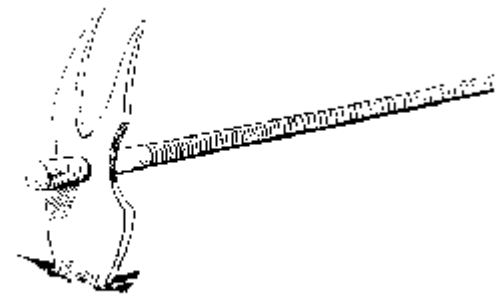

ZO ZO zo Zo



ZOMBIE
zombie

zombie
Zombie

ZO ZO zo Zo

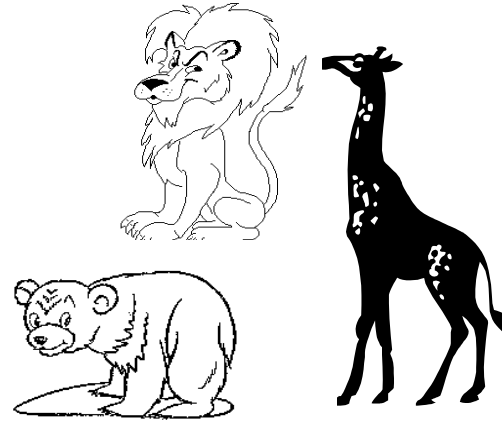

ZOO

ZOO

zoo

Zoo

ZO ZO zo Zo



ZORRO

zorro

Cerca le ZO

ZO FO ZA FO ZO ZE ZO
ZU ZO ZI VO ZO ZI ZA
ZO ZA NO GO MO FO ZO

Cerca le ZO

zo ze zo za mo co zo za
ze zo fo zo lo zu zi zo
zo co lo zo za zo co zo

Cerca le *zo*

zo ze za zo zi za zo to
zo vo zo ze vo zo go zo
ze zo za lo zo vo lo zo

Cerca le *Lo*

Vo Lo La Po Po Lo Lo Li
Lo La Li Go Lo La Le Lo
Bo Lo Go Lo Fo Le Lo So

Leggi

ZO

Zo

ZO

zo

ZO

OZ

Oz

OZ

Oz

OZ

ZO

ZO

Zo

zo

ZO

OZ

Oz

OZ

Oz

OZ

A ZO

e zo

E ZO

I ZO

O ZO

U ZO

a zo

i zo

e zo

i zo

O ZO

U ZO

O zo

A ZO

e zo

i zo

O zo

u zo

u zo

a zo¹⁹⁷

Leggi

Zoccoli



Lo zoo

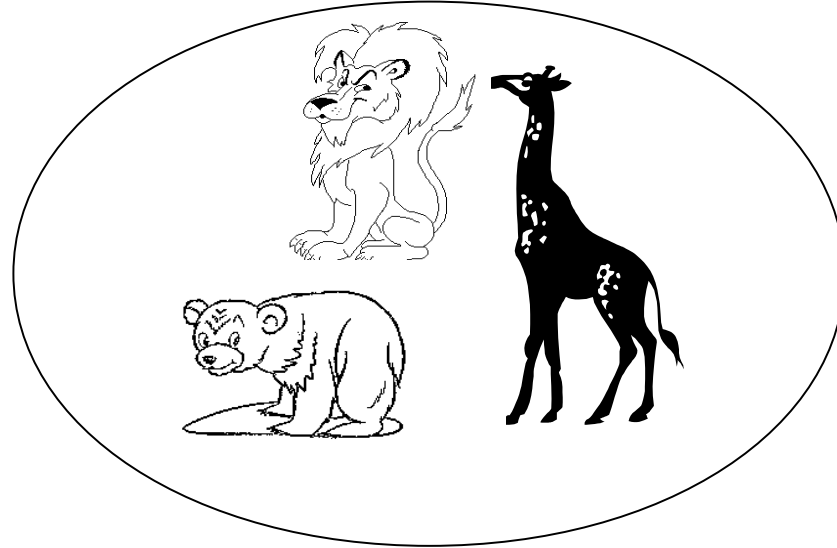

Zorro

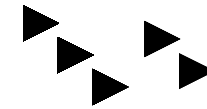

Il pozzo

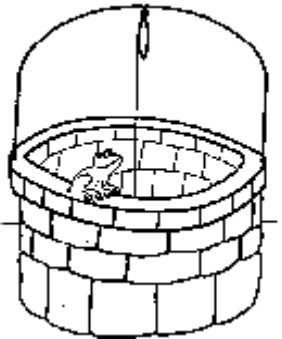

Il pupazzo

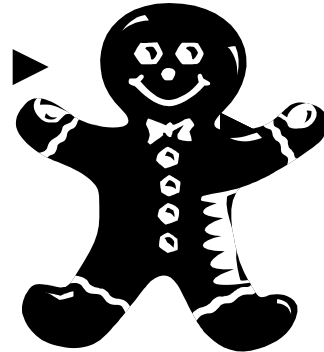

I calzoni



Leggi

Il palazzo



Il razzo

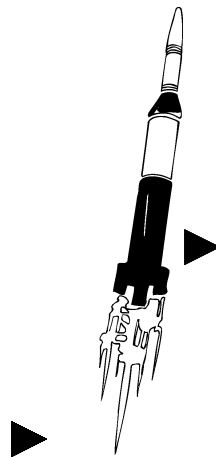

Il mazzolino



Enzo

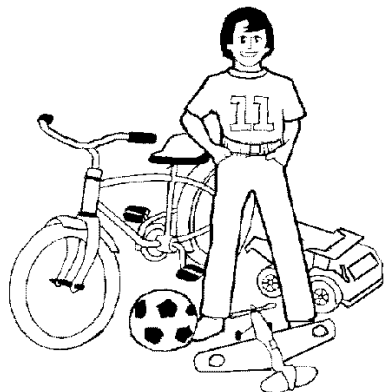

Il pezzo

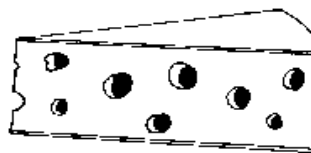

La tazzona



Leggi

Enzo ama l'oziò



Il cavallo ha lo zoccolo

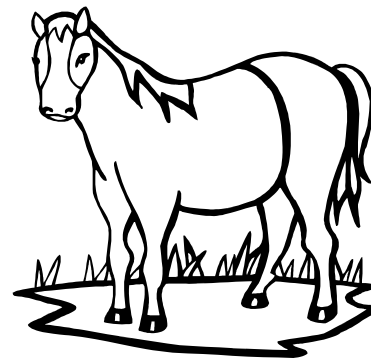

La giraffa è nello zoo

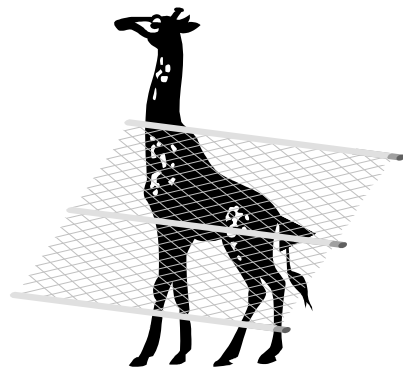

Un mazzolino di fiori

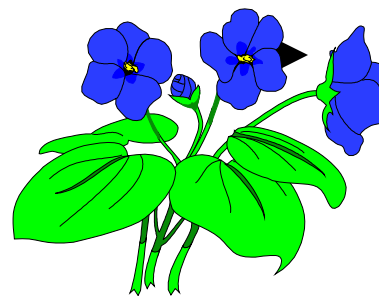

leggi e associa

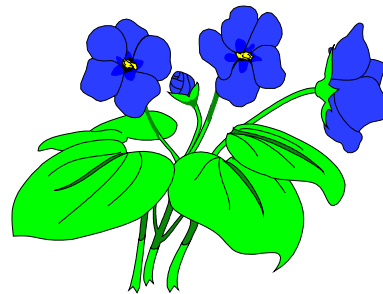
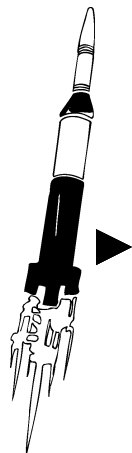
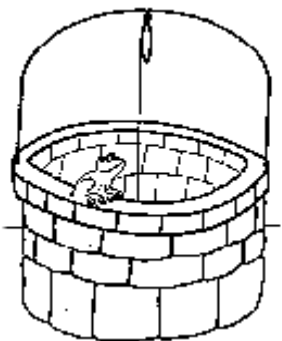

Il razzo

Il mazzolino

Il pupazzo

Il pozzo

Leggi

Lo zi

zo ze

Zo za

ze zo

Za zo

zo zi

nu zo

No zo

Lo ni

ZO NE

na zo

zo mu

O zo

E ZI

O zo

O ze

I VA

u zo

O za

u nu

o zo

a no

a zo

i ni

O zo

a ne

i zo

ZO come ...

zo come...



?

come ...

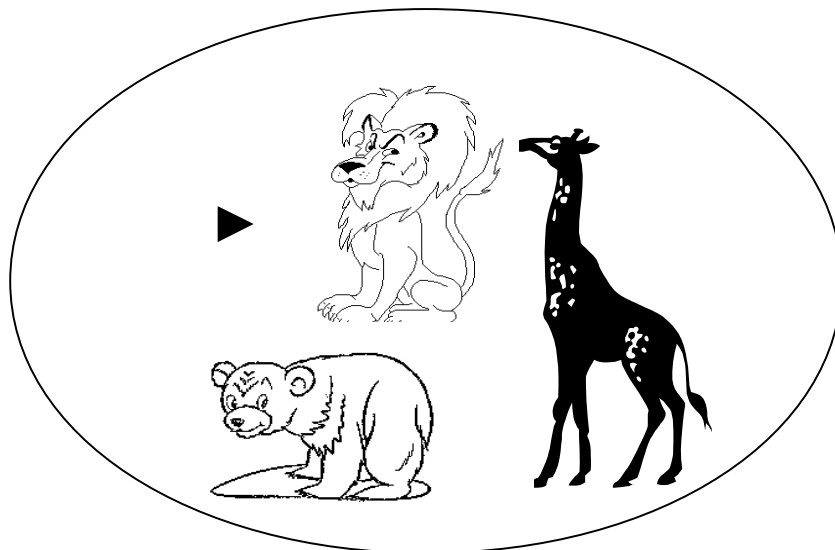

ZO come ...

zo come ...

zo come ...

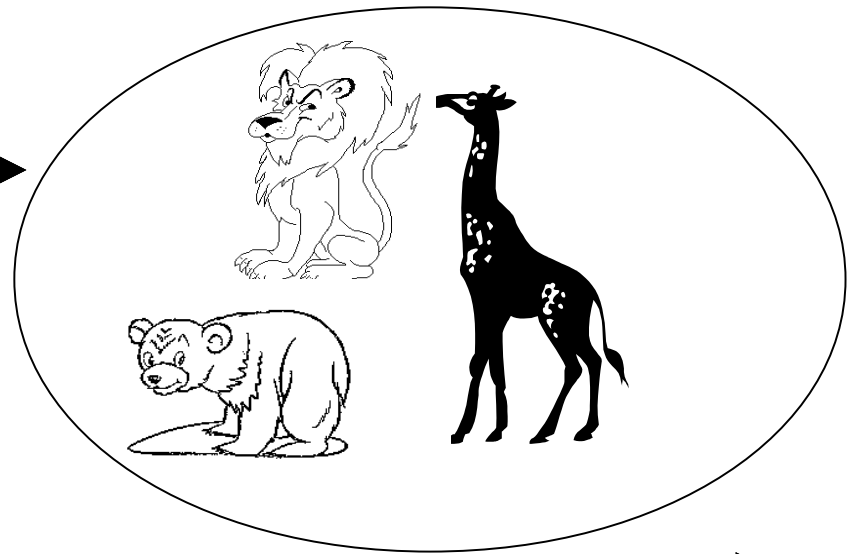

ZI come ...

zi come ...

zi come ...



ZO come ...

zo come ...

zo come ...

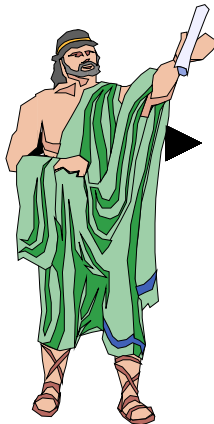
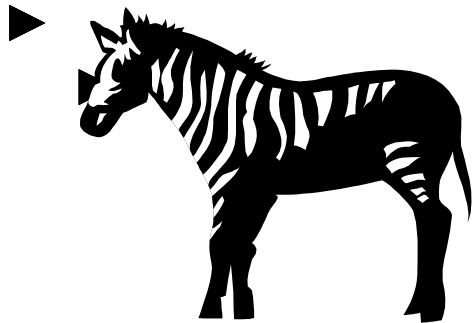

ZE come ...

ze come ...

ze come ...

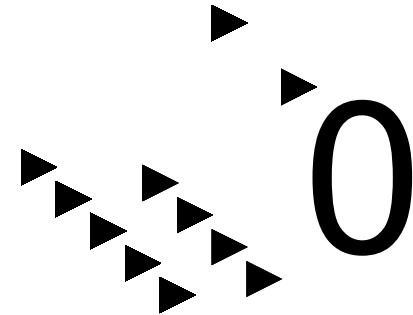
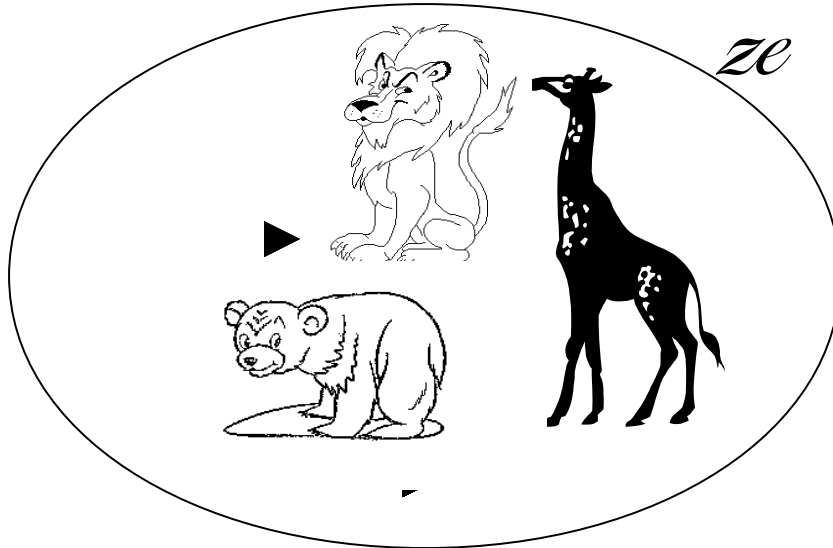

ZU zu *zu* *Zu*



ZUCCA

zucca

zucca

zucca

ZU zu *zu* *Zu*



ZUCCHERO

zucchero

zucchero

Zucchero

ZU zu *zu* *Zu*



ZUPPIERA

zuppiera

zuppiera

Zuppiera

Cerca le ZU

ZU ZA MU FU ZU ZE ZU
TU ZU ZI ZU ZU ZE MU
ZU LU ZO GU MU ZA ZU

Cerca le ZU

zu pu zu zo zu cu zu za
ze zu zo zu zo gu zi zu
zu cu za zu fu mu cu zu

Cerca le *zu*

zu mu za zu zi za zu tu
zu vu zu ze zo zu gu zu
ze zu za lu zu vu lu zu

Cerca le *Lu*

Lu Li Lu Lu Ru La Lu La
Lu Le Li Gu Lu Fu Le Lu
Le Lu Gu Lu Fu Mu Lu Su

Leggi

ZU

Zu

ZU

zu

ZU

UZ

uz

UZ

uz

UZ

zu

ZU

Zu

zu

zu

UZ

uz

UZ

uz

UZ

A ZU

e zu

E ZU

I ZU

O ZU

u zu

a zu

i zu

e zu

i zu

o zu

u zu

O zu

A ZU

e zu

i zu

o zu

u zu

u zu

a zu

Leggi

La zucca



La zuppiera



Lo zùfolo

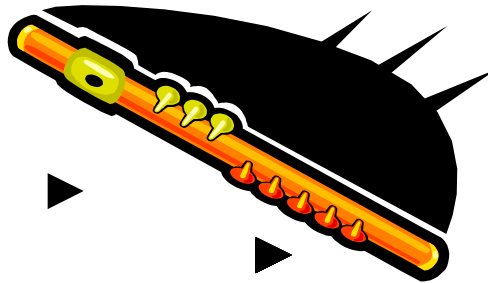

La zuppa

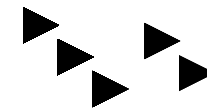
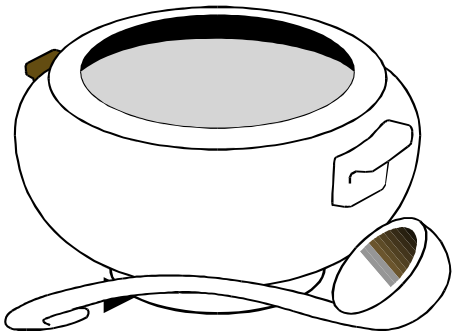

Lo zulù



Leggi

La
cazzuola

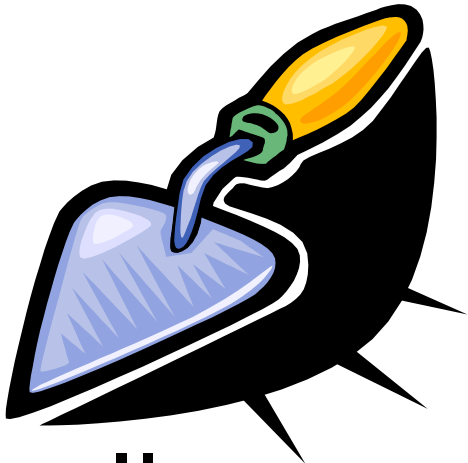

Il pozzo

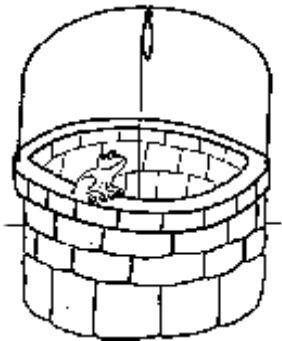

Zoccoli

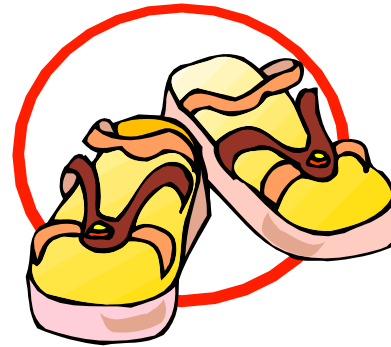

Il pupazzo



Zorro



I calzoni



Leggi

La zuppa è buona

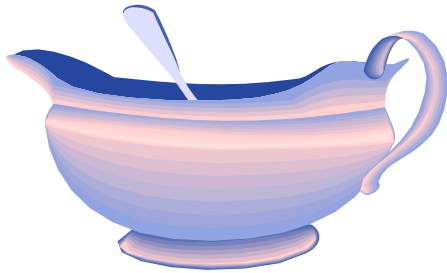

È dolce il suono
dello zupolo

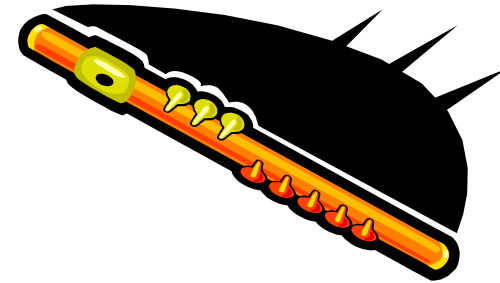

L'asino è zuccone

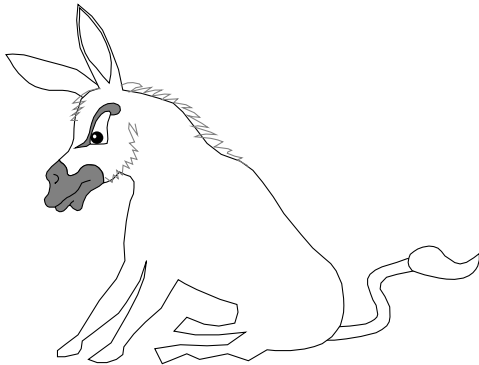

Lo zulù vive al Sud



leggi e associa

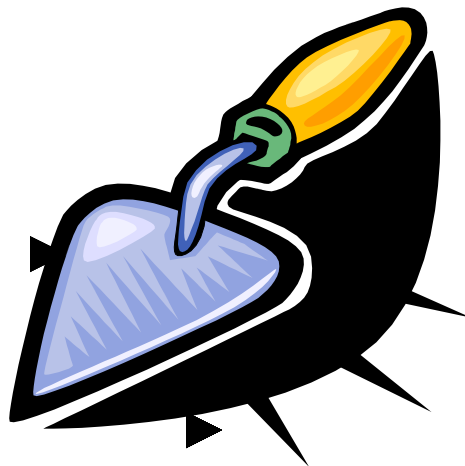

La zuppa

La cazzuola

La zucca

Lo zulù

Leggi

Tu zo

zu zi

Zu ze

To zu

Zu ze

zu zi

za zu

zu nu

Tu no

ZU NI

ne zu

zu na

O zu

E zo

O zu

O zi

I ze

u zu

O za

u nu

o zu

a no

a zu

i ni

O zu

a ne

i zu

ZU come ...

zu come...

zu *come ...*



ZU come ...

zu come ...

ZO come ...

zo come ...

zu come ...

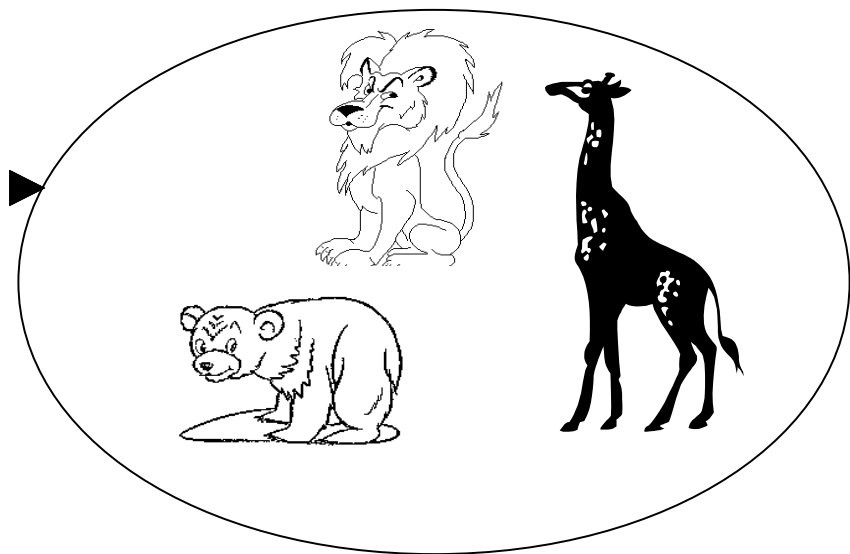

zo come ...

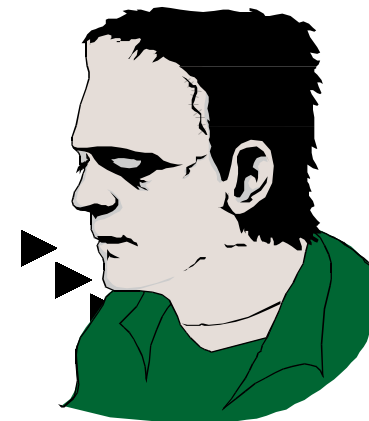
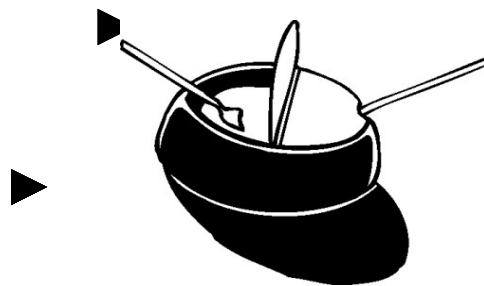

ZU come ...

zu come ...

zu come ...

ZI come ...

zi come ...

zi come ...

