

LETTURA SILLABICA - FONEMATICA

Emidio Tribulato

CI

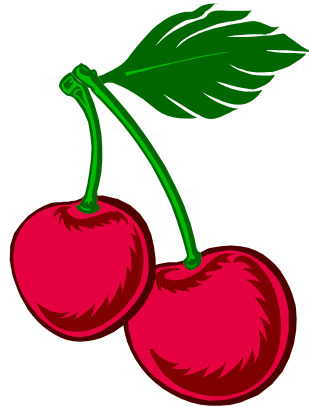

BA

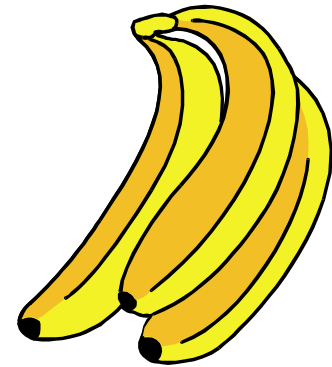

Volume terzo

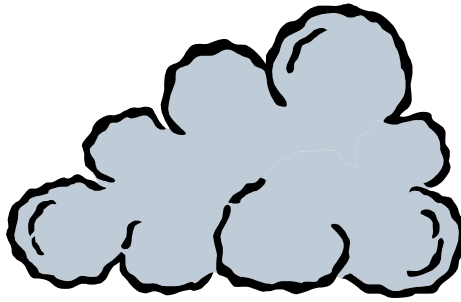

DU

NU

CRA

LETTURA SILLABICO-FONEMATICA
Far associare ogni sillaba con la rispettiva immagine e viceversa.

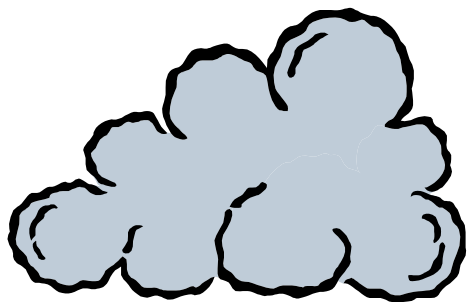

du

nu

cra

LETTURA SILLABICO-FONEMATICA
Far associare ogni sillaba con la rispettiva immagine e viceversa.

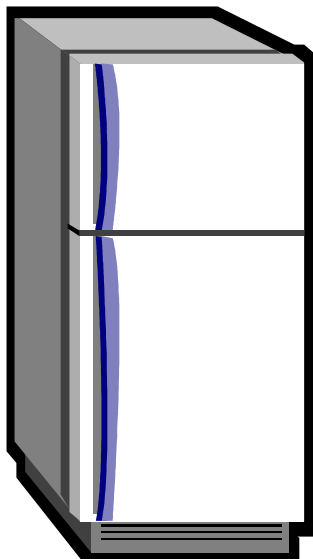
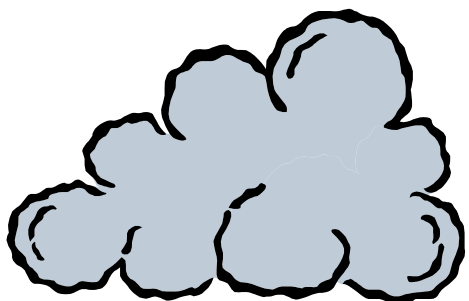

NU

CRA

FRI

LETTURA SILLABICO-FONEMATICA
Far associare ogni sillaba con la rispettiva immagine e viceversa.

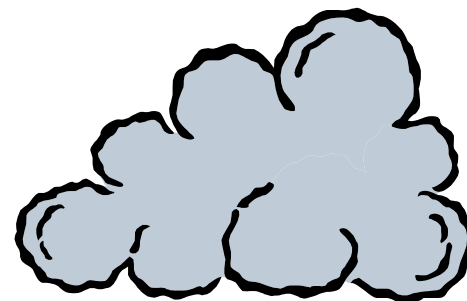
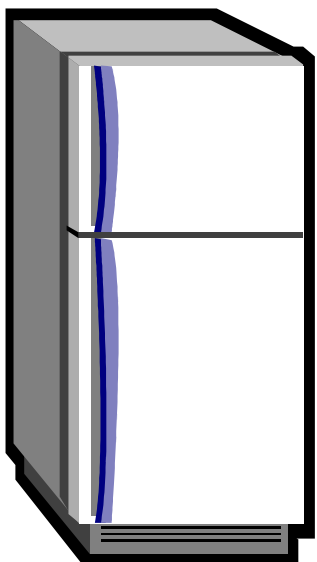

nu

cra

fri

LETTURA SILLABICO-FONEMATICA
Far associare ogni sillaba con la rispettiva immagine e viceversa.

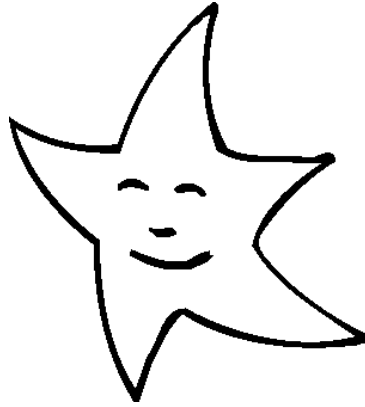
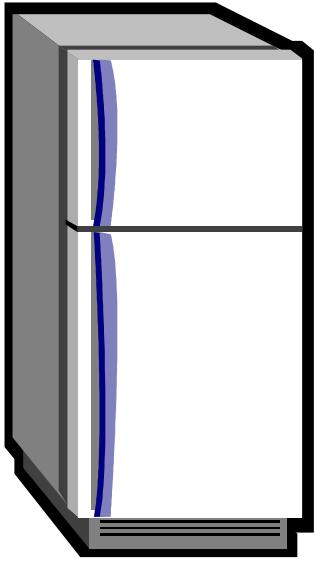

CRA

FRI

STE

LETTURA SILLABICO-FONEMATICA
Far associare ogni sillaba con la rispettiva immagine e viceversa.

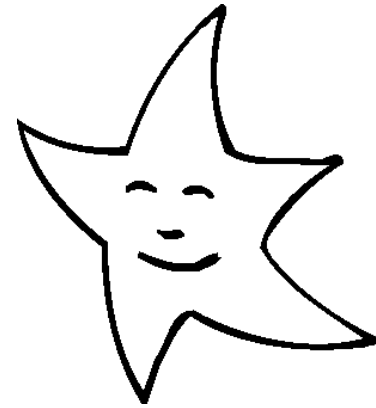
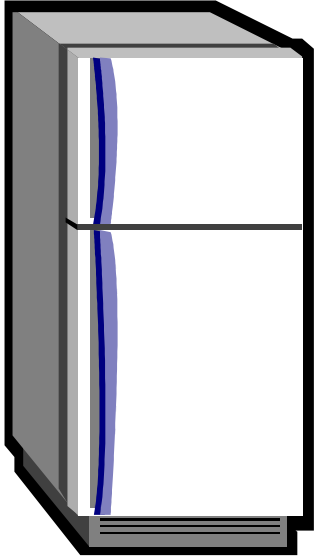

cra

fri

ste

LETTURA SILLABICO-FONEMATICA
Far associare ogni sillaba con la rispettiva immagine e viceversa.

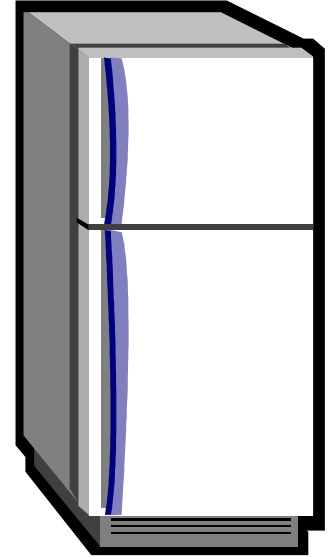
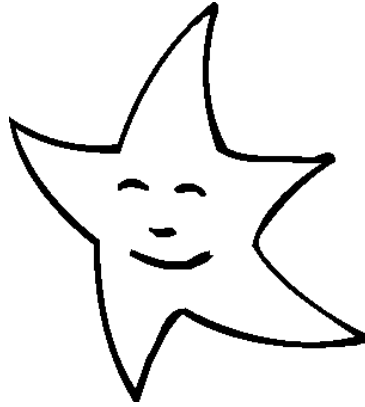
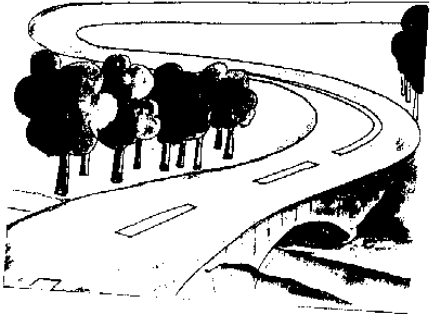

FRI

STE

STRA

LETTURA SILLABICO-FONEMATICA
Far associare ogni sillaba con la rispettiva immagine e viceversa.

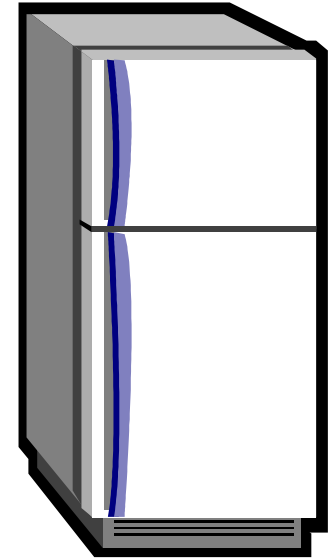
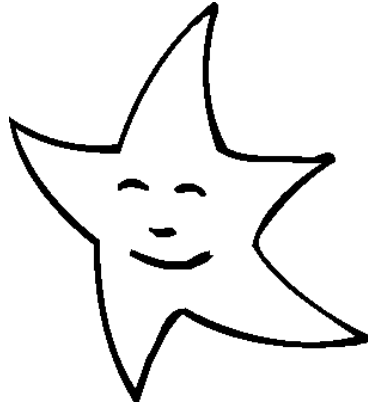
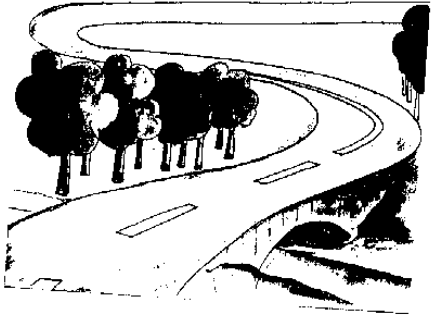

fri

ste

stra

LETTURA SILLABICO-FONEMATICA
Far associare ogni sillaba con la rispettiva immagine e viceversa.

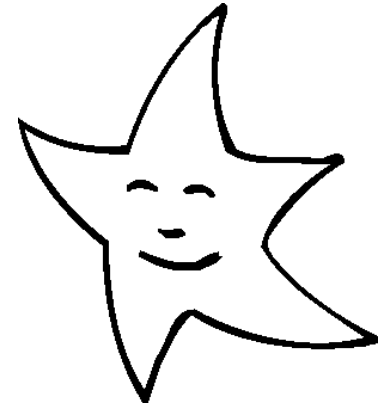
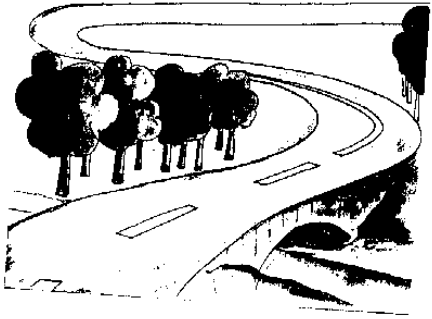

STE

STRA

BRU

LETTURA SILLABICO-FONEMATICA
Far associare ogni sillaba con la rispettiva immagine e viceversa.

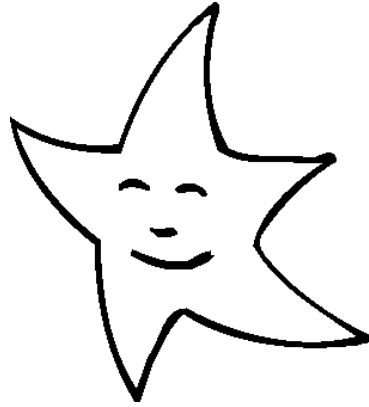
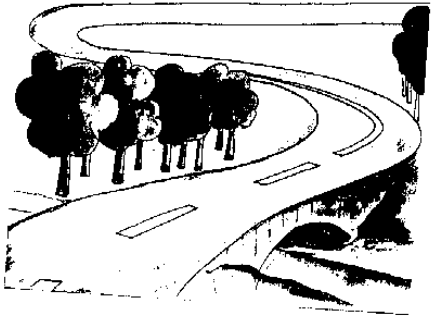

ste

stra

bru

LETTURA SILLABICO-FONEMATICA
Far associare ogni sillaba con la rispettiva immagine e viceversa.

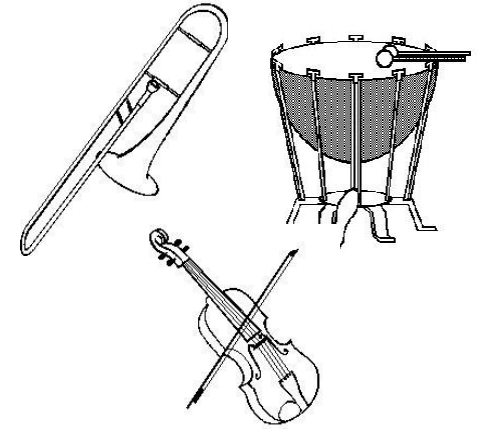
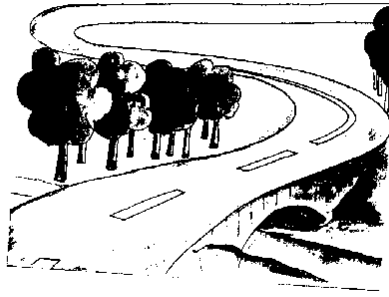

STRA

BRU

STRU

LETTURA SILLABICO-FONEMATICA
Far associare ogni sillaba con la rispettiva immagine e viceversa.

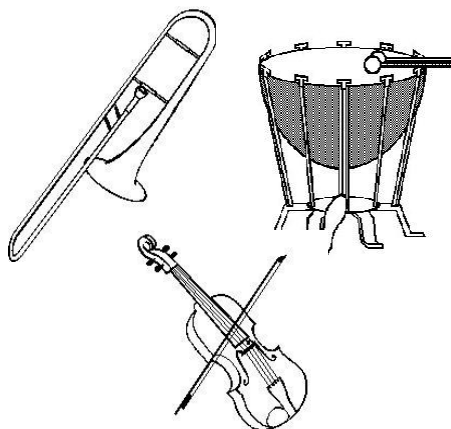
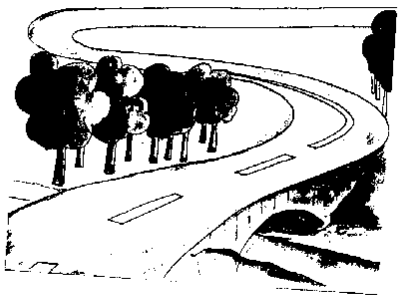

stra

bru

stru

LETTURA SILLABICO-FONEMATICA
Far associare ogni sillaba con la rispettiva immagine e viceversa.

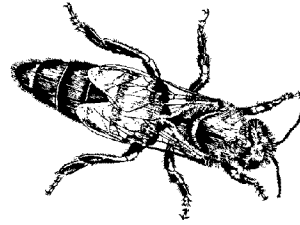
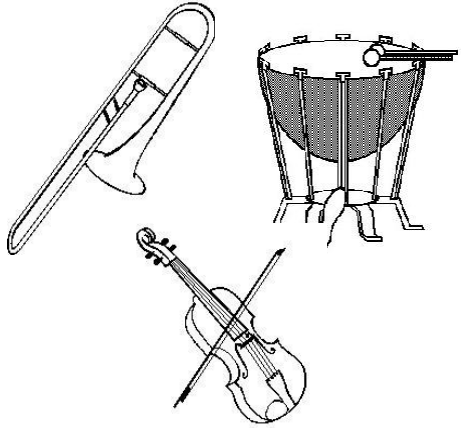

GRILLO



BRU

STRU

GRI

LETTURA SILLABICO-FONEMATICA
Far associare ogni sillaba con la rispettiva immagine e viceversa.

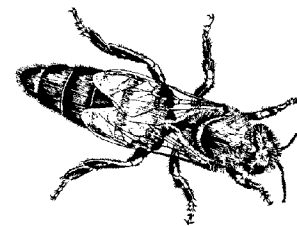
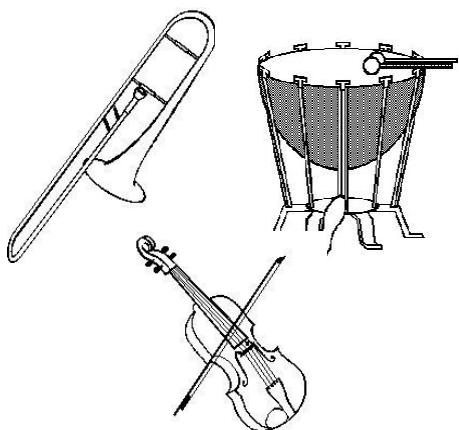

bru

stru

gri

LETTURA SILLABICO-FONEMATICA
Far associare ogni sillaba con la rispettiva immagine e viceversa.

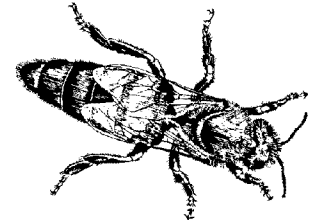
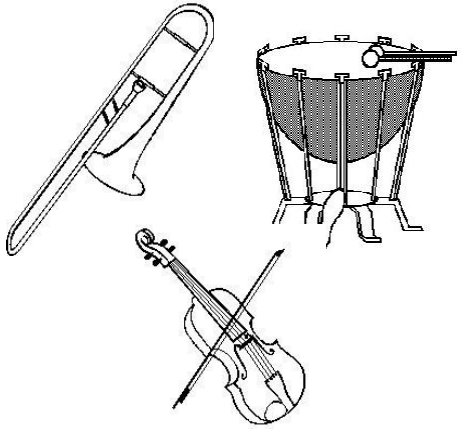

STRU

GRI

STRE

LETTURA SILLABICO-FONEMATICA
Far associare ogni sillaba con la rispettiva immagine e viceversa.

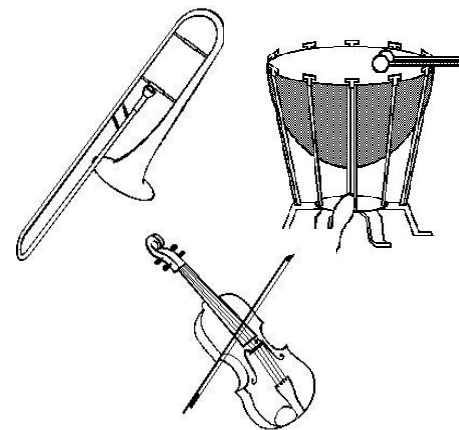
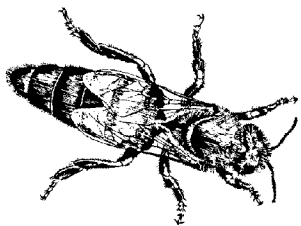

stru

gri

stre

LETTURA SILLABICO-FONEMATICA
Far associare ogni sillaba con la rispettiva immagine e viceversa.

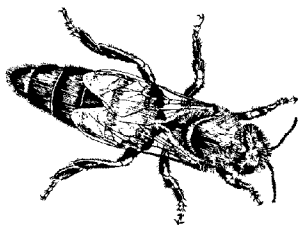

FRATE

GRI

STRE

FRA

LETTURA SILLABICO-FONEMATICA
Far associare ogni sillaba con la rispettiva immagine e viceversa.

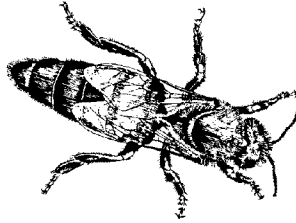

gri

stre

fra

LETTURA SILLABICO-FONEMATICA
Far associare ogni sillaba con la rispettiva immagine e viceversa.



STRE

FRA

STI

LETTURA SILLABICO-FONEMATICA
Far associare ogni sillaba con la rispettiva immagine e viceversa.



stre

fra

sti

LETTURA SILLABICO-FONEMATICA
Far associare ogni sillaba con la rispettiva immagine e viceversa.



FRA

STI

PRE

LETTURA SILLABICO-FONEMATICA
Far associare ogni sillaba con la rispettiva immagine e viceversa.



fra

sti

pre

LETTURA SILLABICO-FONEMATICA
Far associare ogni sillaba con la rispettiva immagine e viceversa.

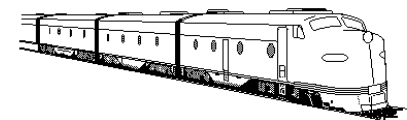

STI

PRE

TRE

LETTURA SILLABICO-FONEMATICA
Far associare ogni sillaba con la rispettiva immagine e viceversa.

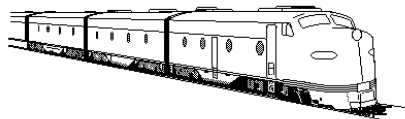

sti

pre

tre

LETTURA SILLABICO-FONEMATICA
Far associare ogni sillaba con la rispettiva immagine e viceversa.

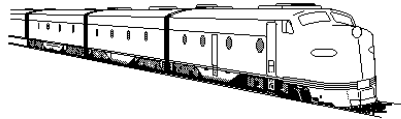
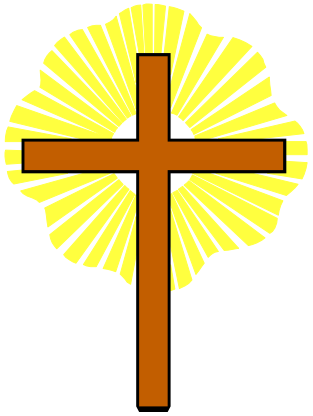

PRE

TRE

CRO

LETTURA SILLABICO-FONEMATICA
Far associare ogni sillaba con la rispettiva immagine e viceversa.

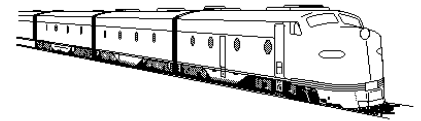
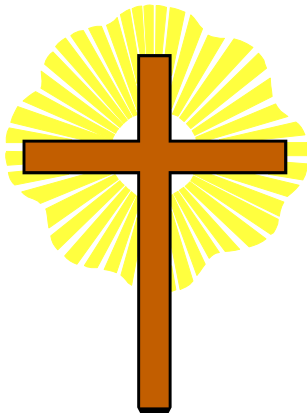

pre

tre

cro

LETTURA SILLABICO-FONEMATICA
Far associare ogni sillaba con la rispettiva immagine e viceversa.

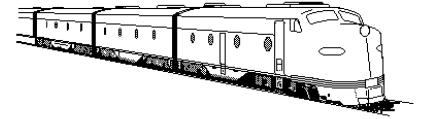
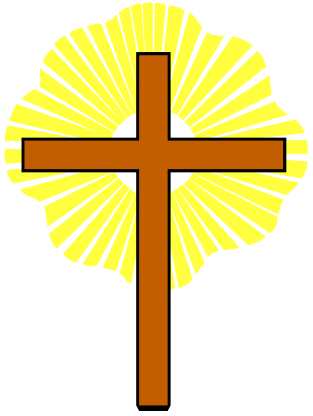

TRE

CRO

FRU

LETTURA SILLABICO-FONEMATICA
Far associare ogni sillaba con la rispettiva immagine e viceversa.

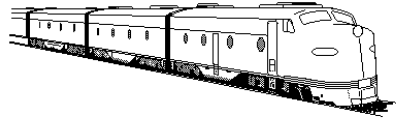
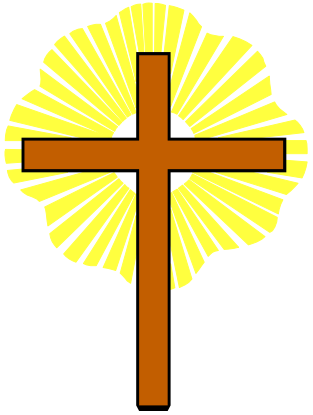

tre

cro

fru

LETTURA SILLABICO-FONEMATICA
Far associare ogni sillaba con la rispettiva immagine e viceversa.

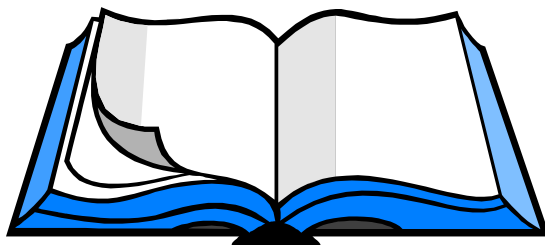
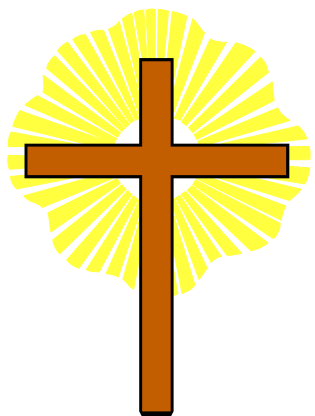

QUADERNO



CRO

FRU

QUA

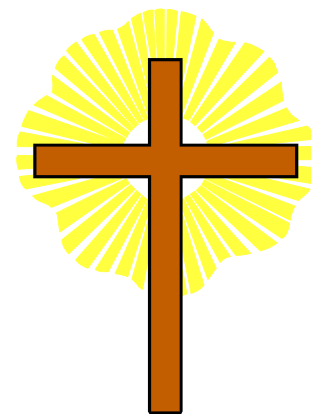
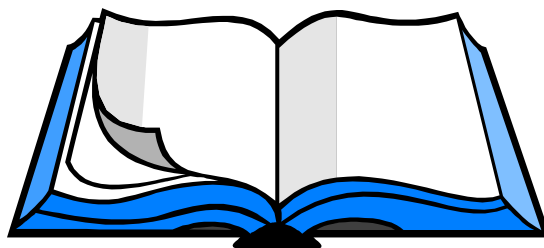

cro

fru

qua

LETTURA SILLABICO-FONEMATICA
Far associare ogni sillaba con la rispettiva immagine e viceversa.

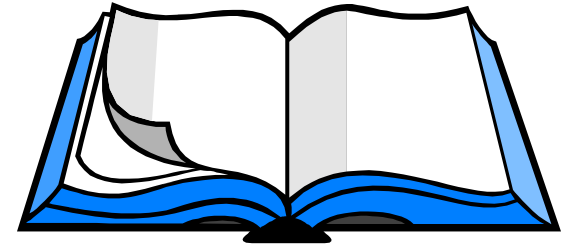

FRU

QUA

BRI

LETTURA SILLABICO-FONEMATICA
Far associare ogni sillaba con la rispettiva immagine e viceversa.

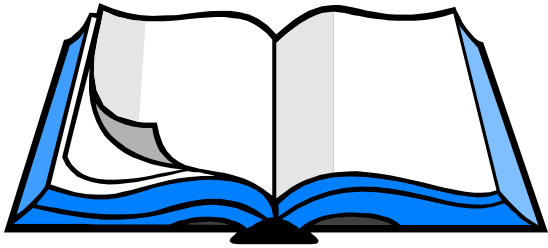

fru

qua

bri

LETTURA SILLABICO-FONEMATICA
Far associare ogni sillaba con la rispettiva immagine e viceversa.

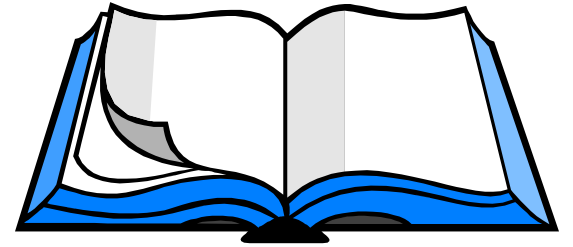
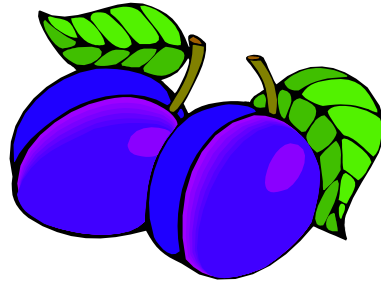

QUA

BRI

PRU

LETTURA SILLABICO-FONEMATICA
Far associare ogni sillaba con la rispettiva immagine e viceversa.

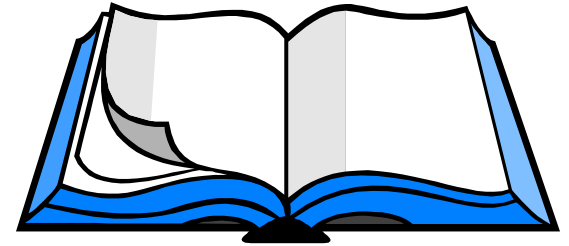
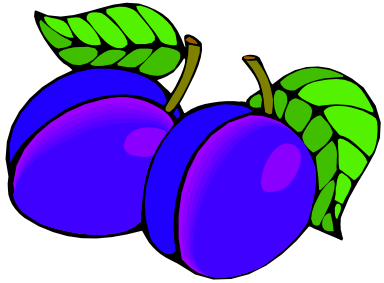

qua

bri

pru

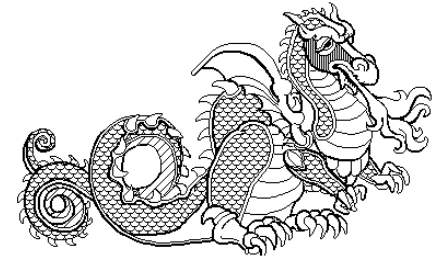
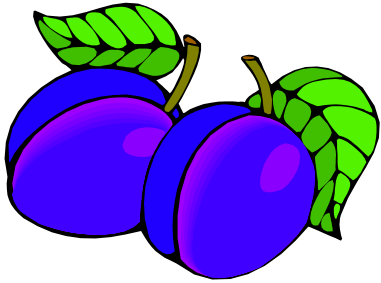

BRI

PRU

DRA

LETTURA SILLABICO-FONEMATICA
Far associare ogni sillaba con la rispettiva immagine e viceversa.

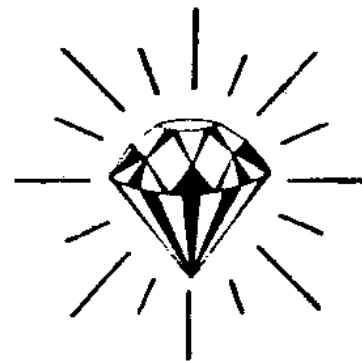
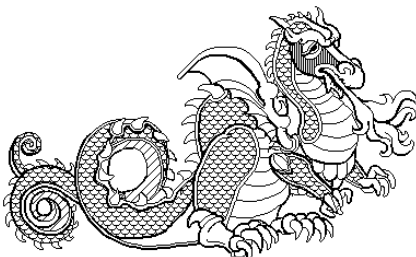
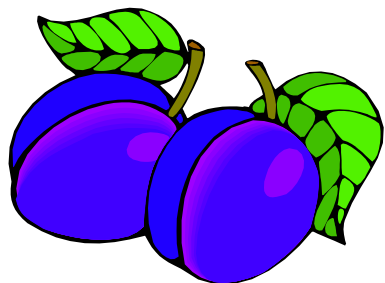

bri

pru

dra

LETTURA SILLABICO-FONEMATICA
Far associare ogni sillaba con la rispettiva immagine e viceversa.

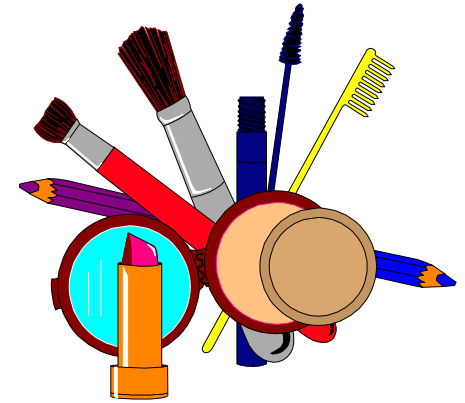
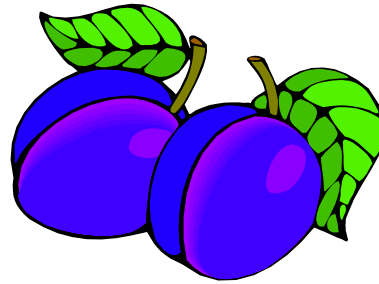
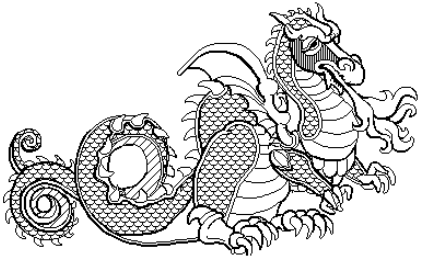

TRUCCHI

PRU

DRA

TRU

LETTURA SILLABICO-FONEMATICA
Far associare ogni sillaba con la rispettiva immagine e viceversa.

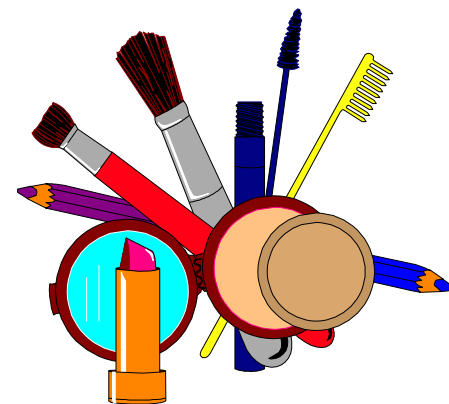
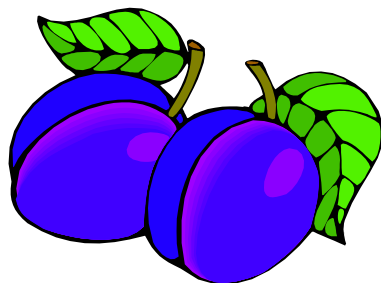
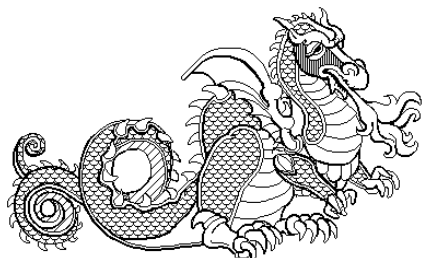

pru

dra

tru

LETTURA SILLABICO-FONEMATICA
Far associare ogni sillaba con la rispettiva immagine e viceversa.

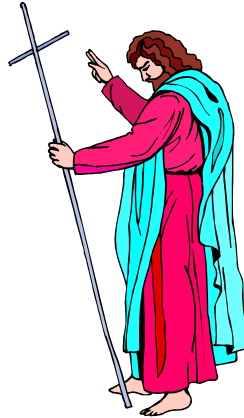
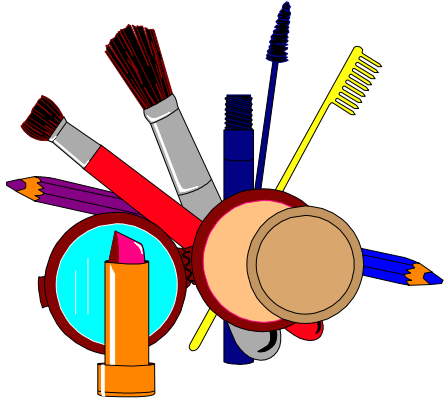

CRISTO

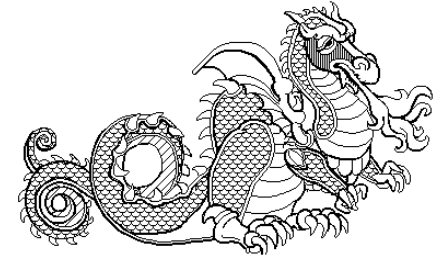

DRA

TRU

CRI

LETTURA SILLABICO-FONEMATICA
Far associare ogni sillaba con la rispettiva immagine e viceversa.

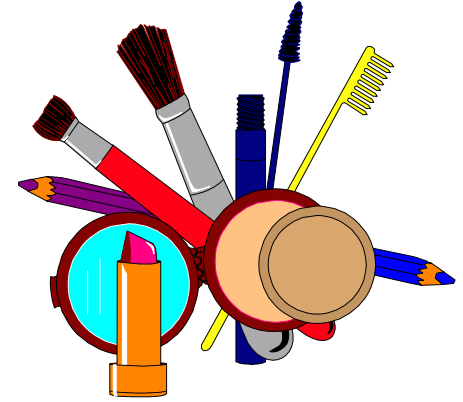
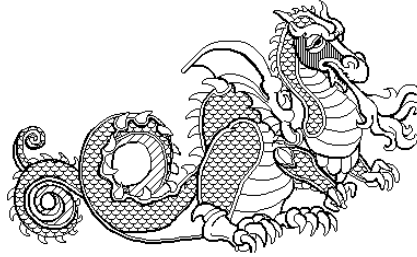
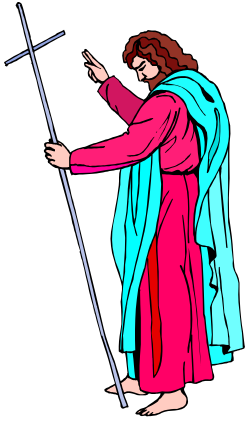

dra

tru

cri

LETTURA SILLABICO-FONEMATICA
Far associare ogni sillaba con la rispettiva immagine e viceversa.

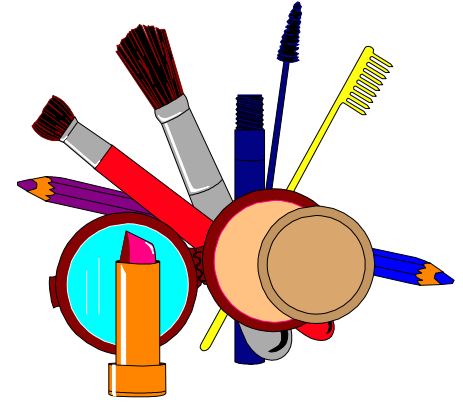
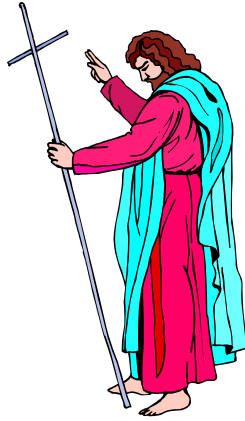

TRU

CRI

BRE

LETTURA SILLABICO-FONEMATICA
Far associare ogni sillaba con la rispettiva immagine e viceversa.

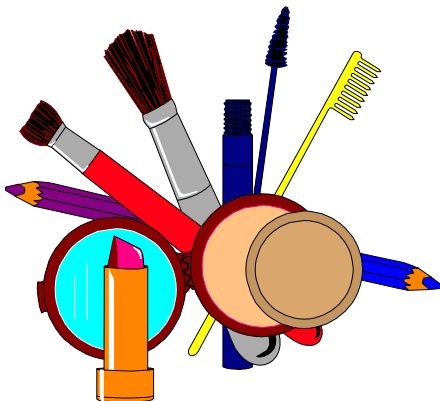
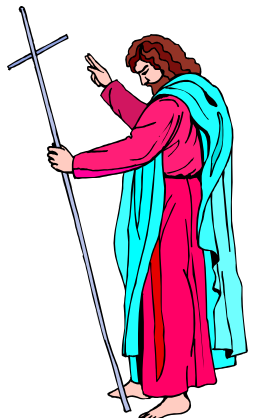

tru

cri

bre

LETTURA SILLABICO-FONEMATICA
Far associare ogni sillaba con la rispettiva immagine e viceversa.

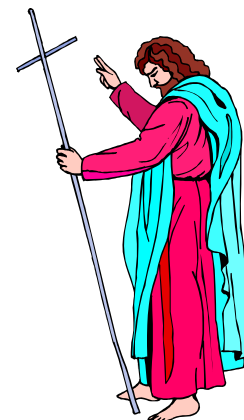

CRI

BRE

BRO

LETTURA SILLABICO-FONEMATICA
Far associare ogni sillaba con la rispettiva immagine e viceversa.

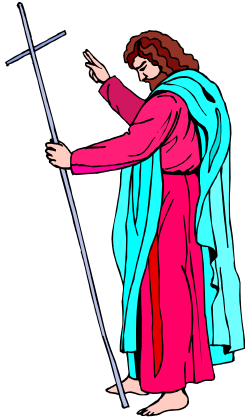

cri

bre

bro

LETTURA SILLABICO-FONEMATICA
Far associare ogni sillaba con la rispettiva immagine e viceversa.

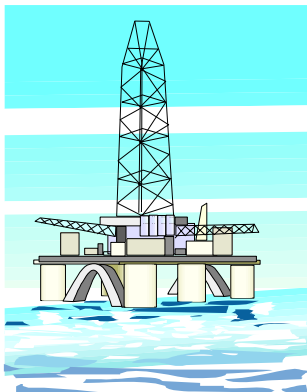

TRIVELLA



BRE

BRO

TRI

LETTURA SILLABICO-FONEMATICA
Far associare ogni sillaba con la rispettiva immagine e viceversa.

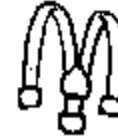
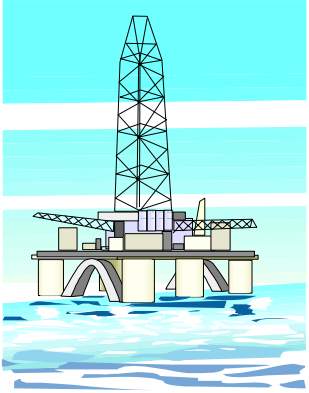

bre

bro

tri

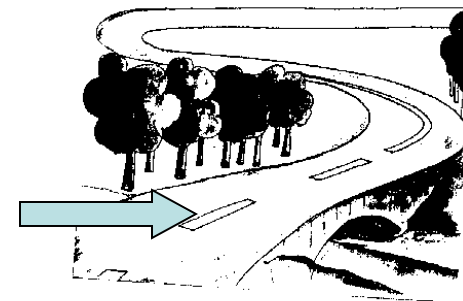
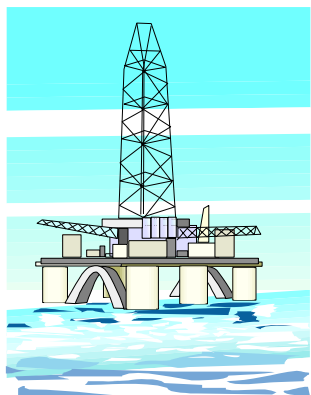

STRISCE

BRO

TRI

STRI

LETTURA SILLABICO-FONEMATICA
Far associare ogni sillaba con la rispettiva immagine e viceversa.

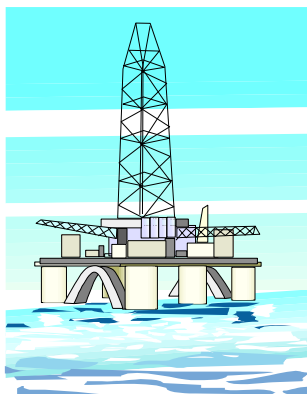
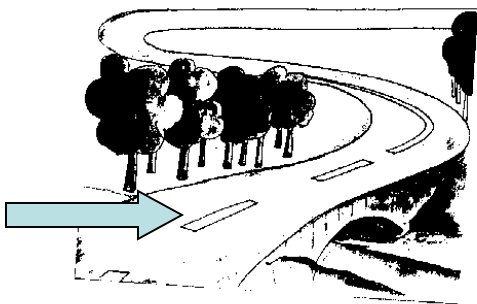

bro

tri

stri

LETTURA SILLABICO-FONEMATICA
Far associare ogni sillaba con la rispettiva immagine e viceversa.

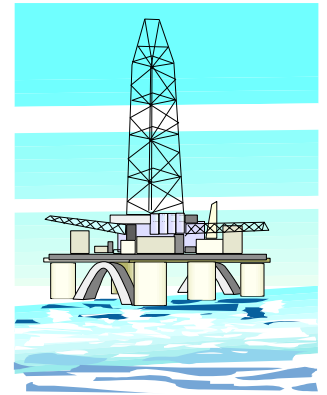
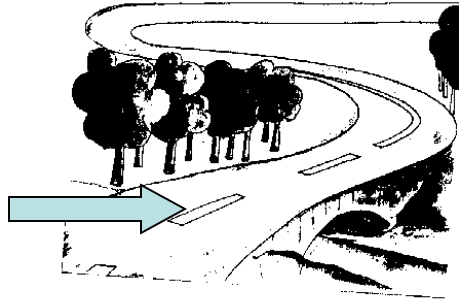
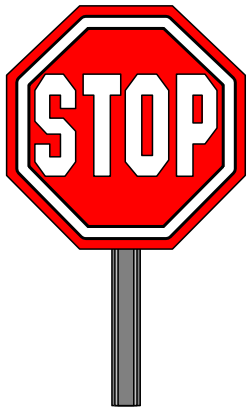

TRI

STRI

STO

LETTURA SILLABICO-FONEMATICA
Far associare ogni sillaba con la rispettiva immagine e viceversa.

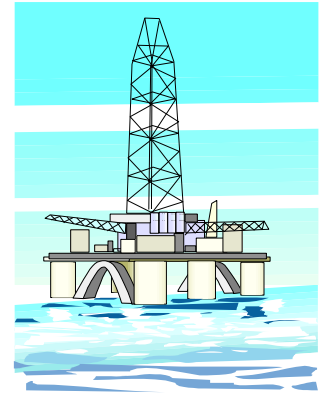
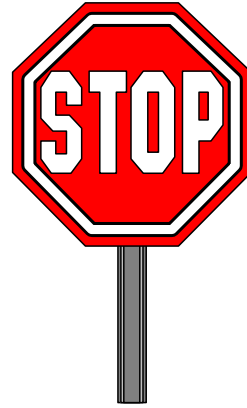
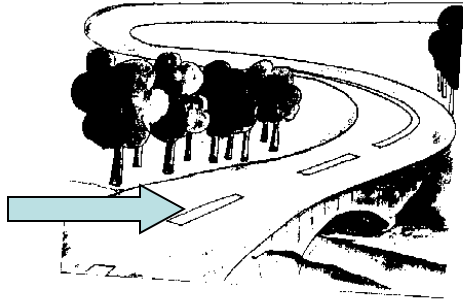

tri

stri

sto

LETTURA SILLABICO-FONEMATICA
Far associare ogni sillaba con la rispettiva immagine e viceversa.

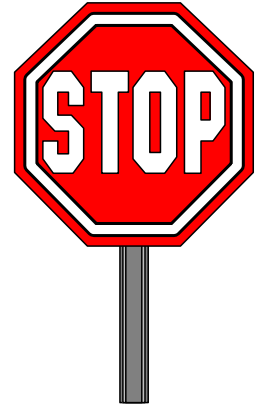
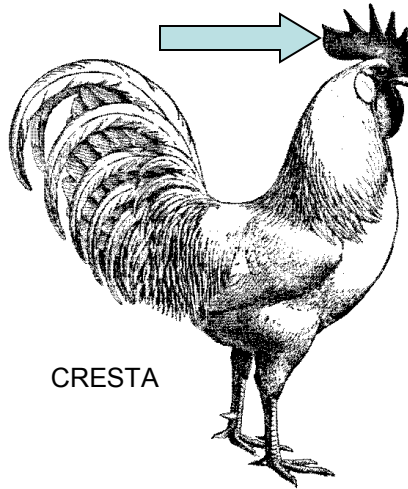
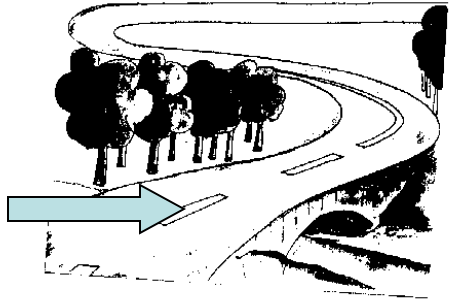

STRI

STO

CRE

LETTURA SILLABICO-FONEMATICA
Far associare ogni sillaba con la rispettiva immagine e viceversa.

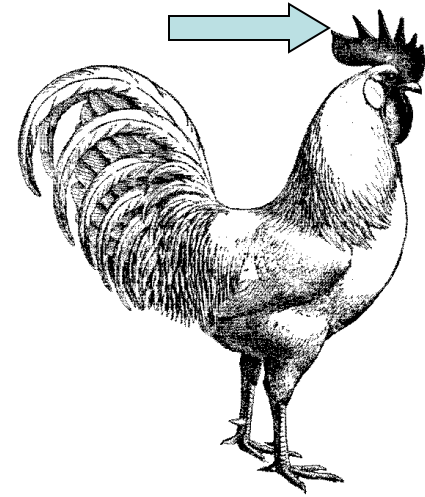
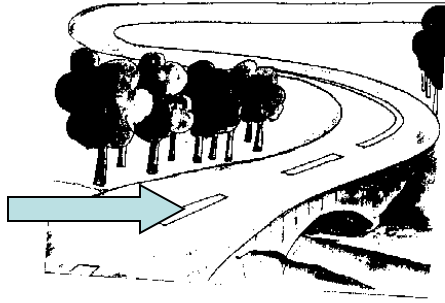

stri

sto

cre

LETTURA SILLABICO-FONEMATICA
Far associare ogni sillaba con la rispettiva immagine e viceversa.

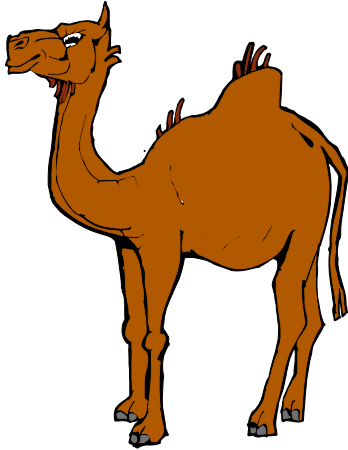

DROMEDARIO

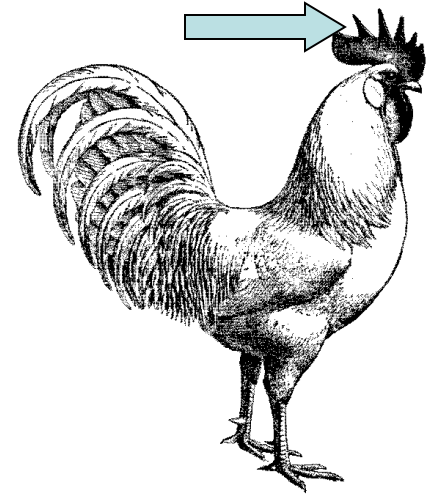

STO

CRE

DRO

LETTURA SILLABICO-FONEMATICA
Far associare ogni sillaba con la rispettiva immagine e viceversa.

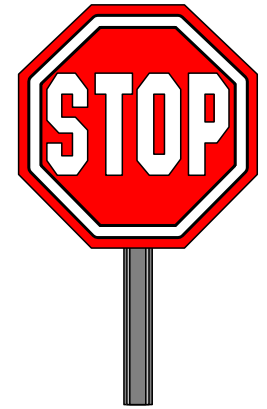
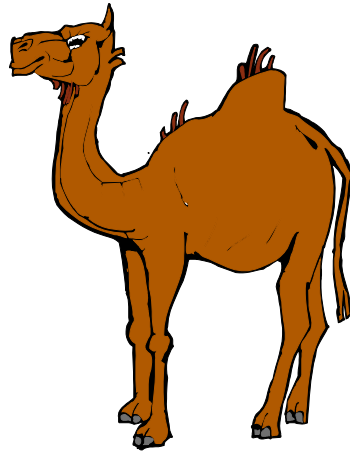
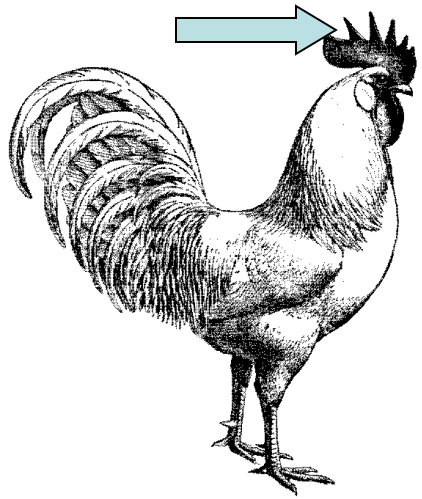

sto

cre

dro

LETTURA SILLABICO-FONEMATICA
Far associare ogni sillaba con la rispettiva immagine e viceversa.

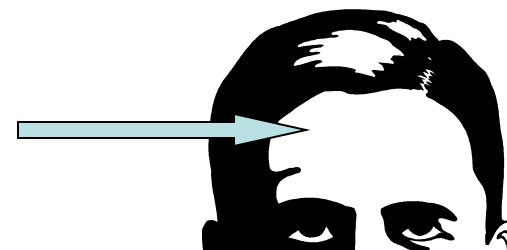
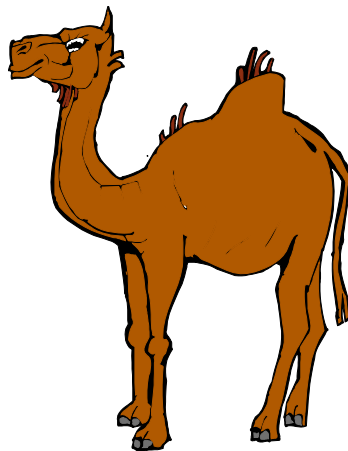
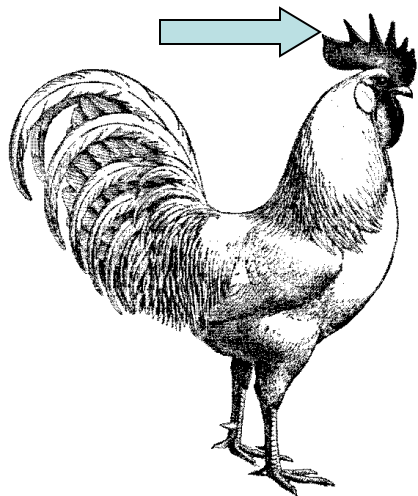

CRE

DRO

FRON

LETTURA SILLABICO-FONEMATICA
Far associare ogni sillaba con la rispettiva immagine e viceversa.

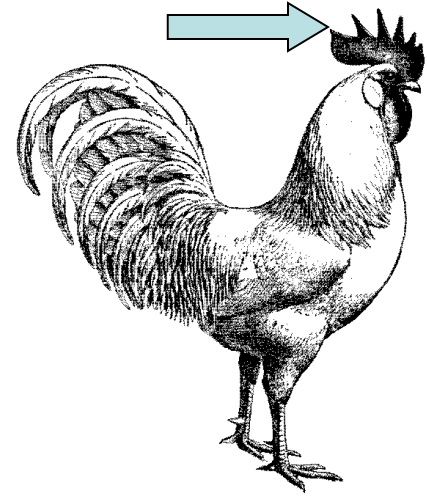
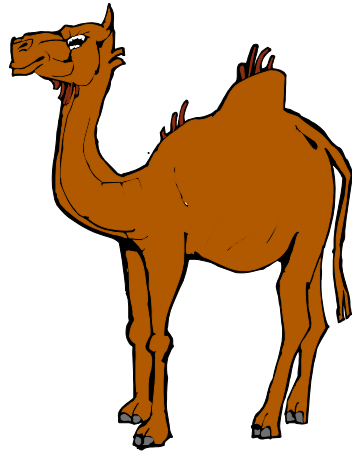
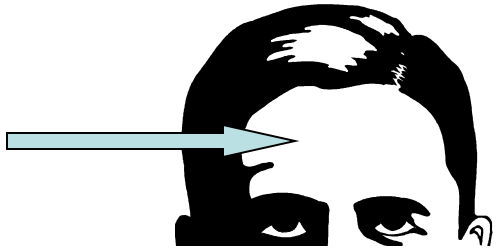

cre

dro

fron

LETTURA SILLABICO-FONEMATICA
Far associare ogni sillaba con la rispettiva immagine e viceversa.

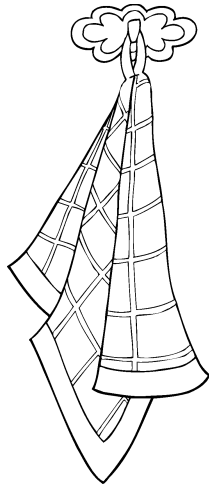
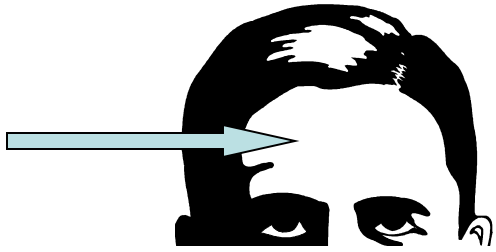

STROFINACCIO

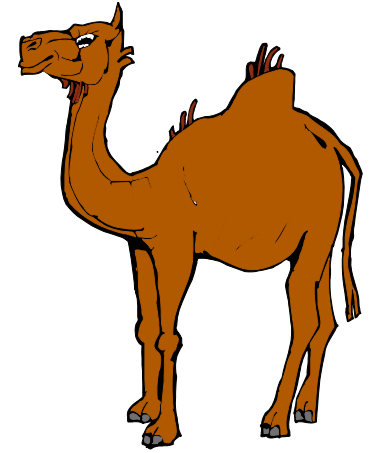

DRO

FRON

STRO

LETTURA SILLABICO-FONEMATICA
Far associare ogni sillaba con la rispettiva immagine e viceversa.

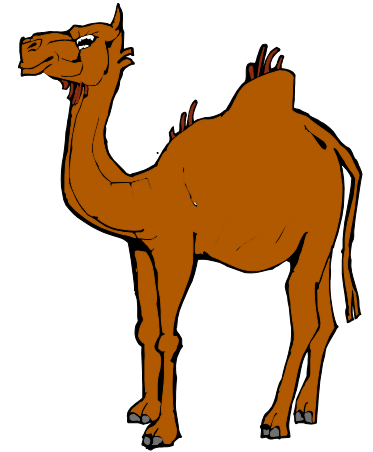
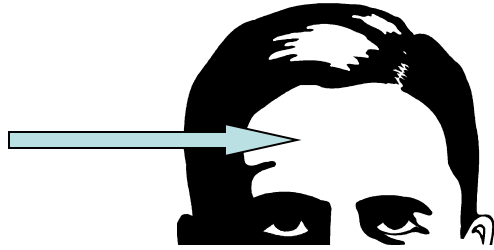
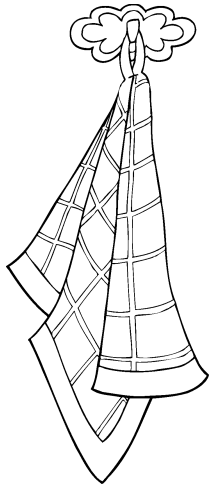

dro

fron

stro

LETTURA SILLABICO-FONEMATICA
Far associare ogni sillaba con la rispettiva immagine e viceversa.

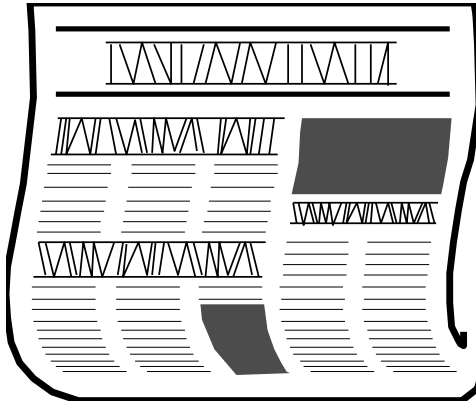
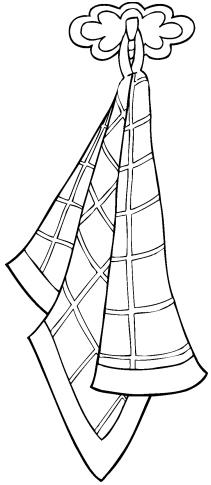

QUOTIDIANO

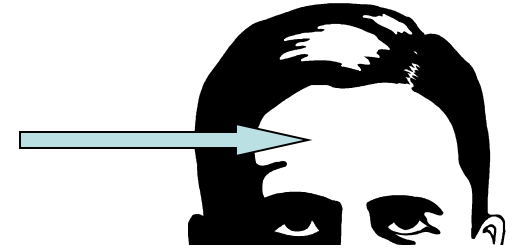

FRON

STRO

QUO

LETTURA SILLABICO-FONEMICA
Far associare ogni sillaba con la rispettiva immagine e viceversa.

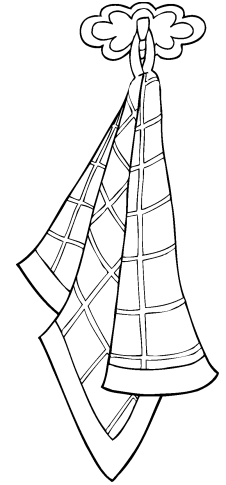
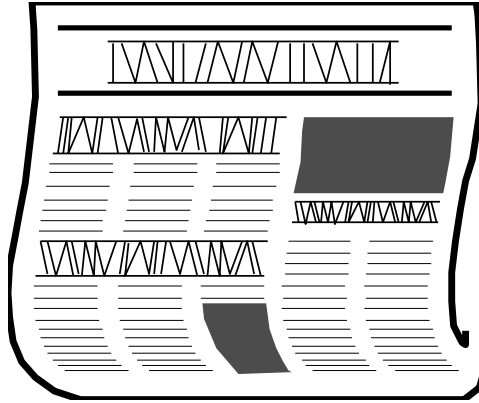
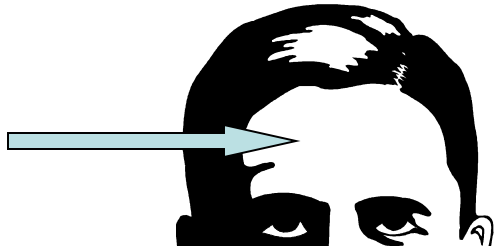

fron

stro

quo

LETTURA SILLABICO-FONEMATICA
Far associare ogni sillaba con la rispettiva immagine e viceversa.

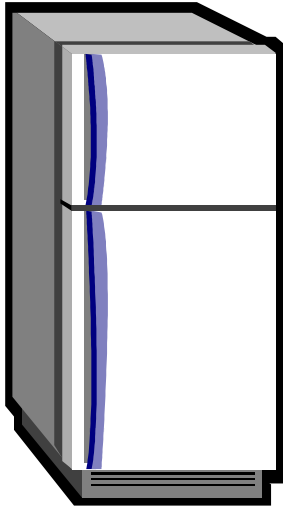

- CRAVATTA

- FRIGORIFERO

- STELLA

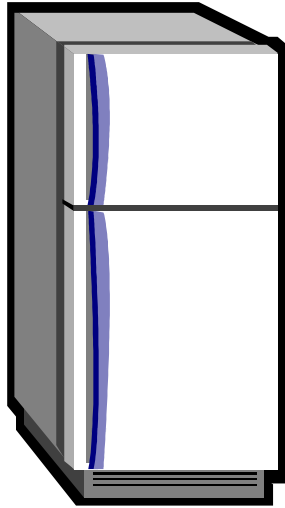

- cravatta

- frigorifero

- stella

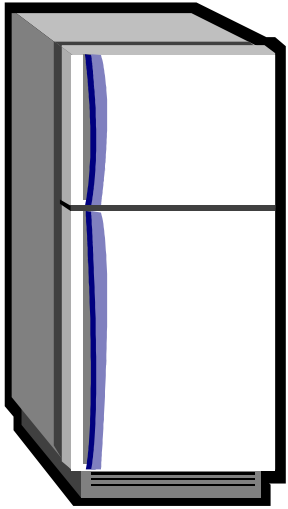

- CRAVATTA

- FRIGORIFERO

- STELLA

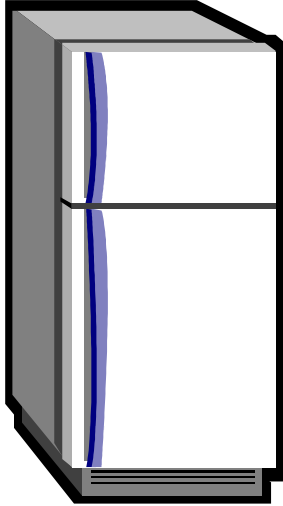

- cravatta

- frigorifero

- stella

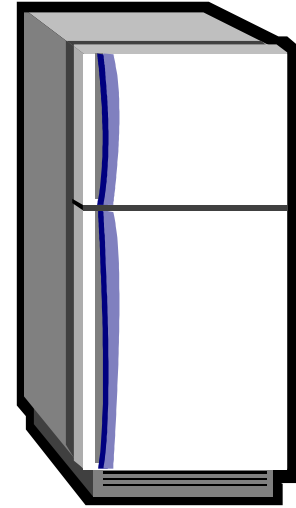

- FRIGORIFERO
 - STELLA
 - STRADA

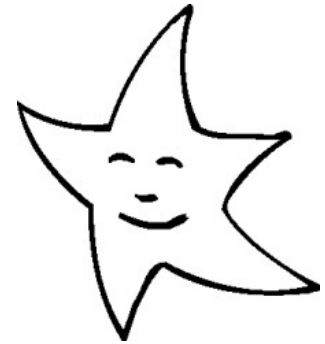
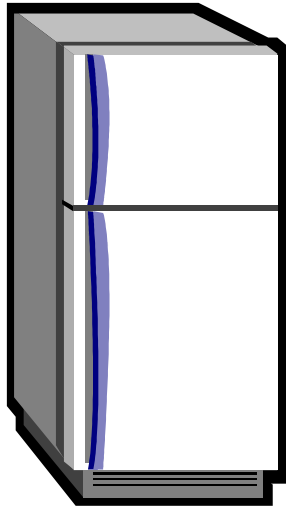

- frigorifero

- stella

- strada



- STELLA

- STRADA

- BRUCO

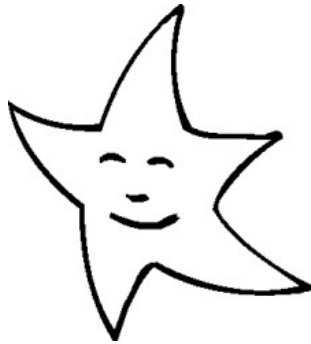

- stella

- strada

- bruco



- STRADA

- BRUCO

- STRUZZO

LETTURA SILLABICO-FONEMATICA

Far leggere e associare ogni parola all'immagine corrispondente.



- strada

- bruco

- struzzo

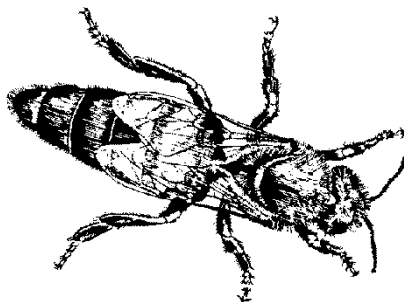

• BRUCO

• STRUZZO

• GRILLO

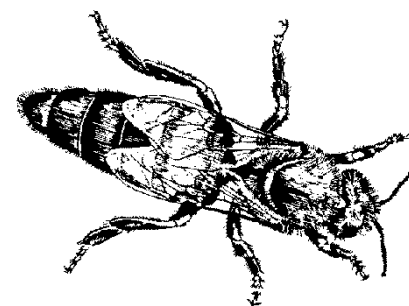

• bruco

• struzzo

• grillo

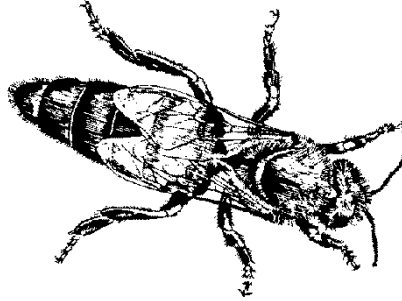

• STRUZZO

• GRILLO

• STREGA

LETTURA SILLABICO-FONEMATICA

Far leggere e associare ogni parola all'immagine corrispondente.

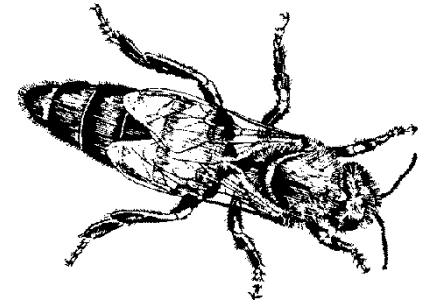

• struzzo

• grillo

• strega

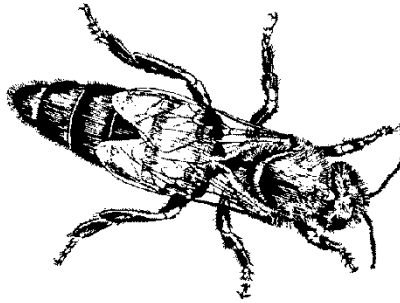

• GRILLO

• STREGA

• FRATE

LETTURA SILLABICO-FONEMATICA

Far leggere e associare ogni parola all'immagine corrispondente.

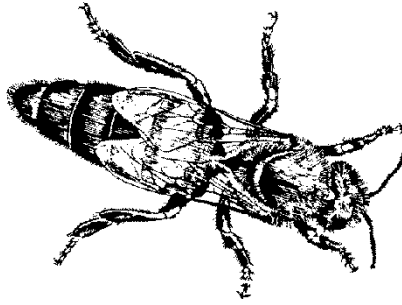

- grillo

- strega

- frate



• STREGA

• FRATE

• STIVALI



• strega

• frate

• stivali



• FRATE

• STIVALI

• PREGARE



• frate

• stivali

• pregare

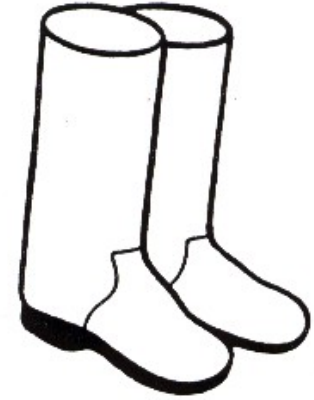
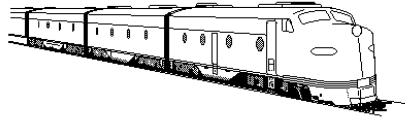

• STIVALI

• PREGARE

• TRENO

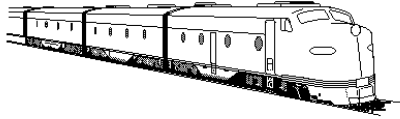

• stivali

• pregare

• treno

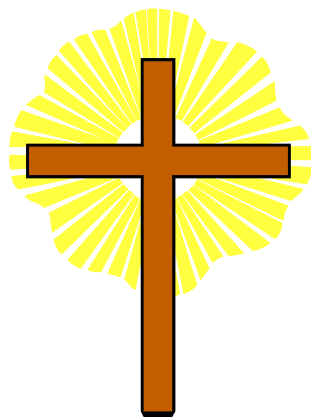
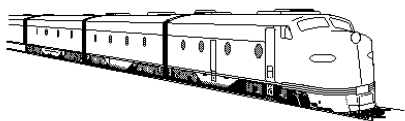

• PREGARE

• TRENO

• CROCE

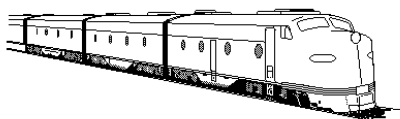
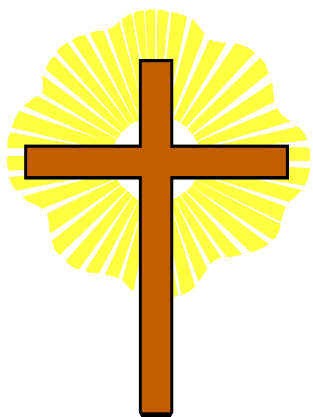

• pregare

• treno

• croce

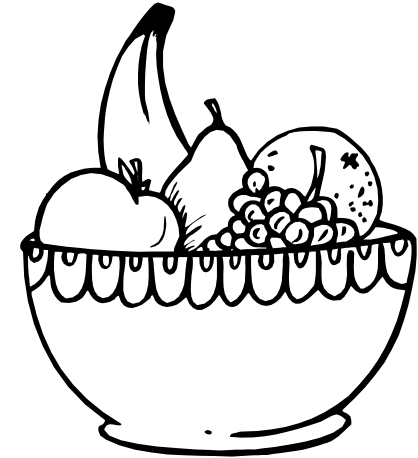
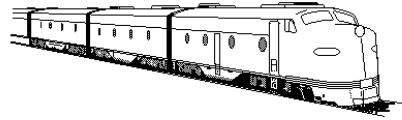
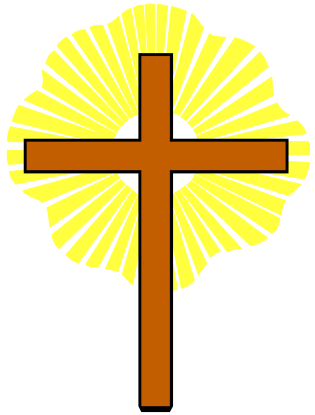

• TRENO

• CROCE

• FRUTTA

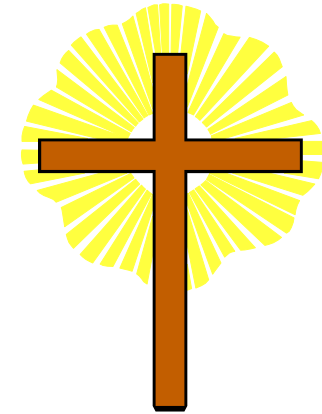
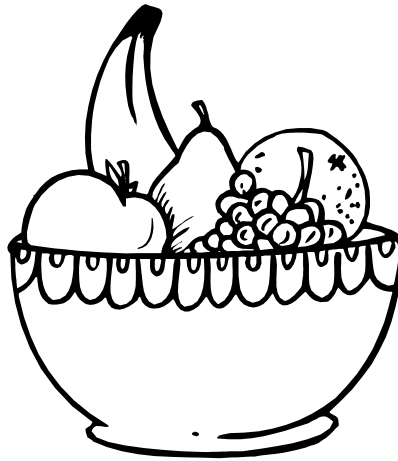
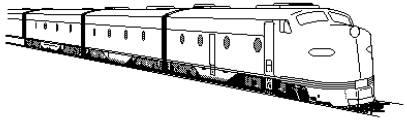

• treno

• croce

• frutta

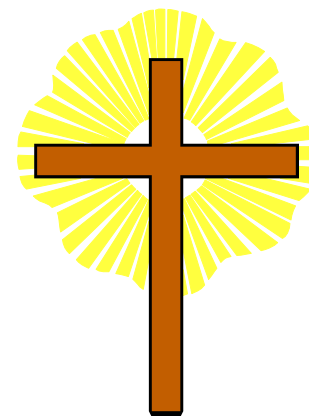
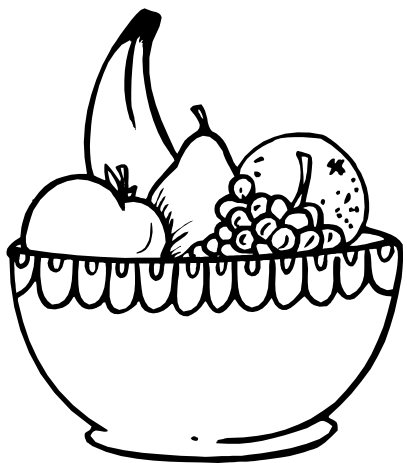

• CROCE

• FRUTTA

• QUADRO

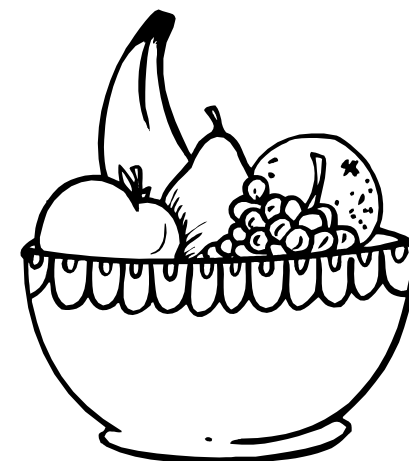
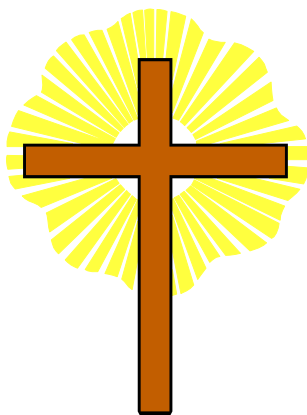

- croce

- frutta

- quadro

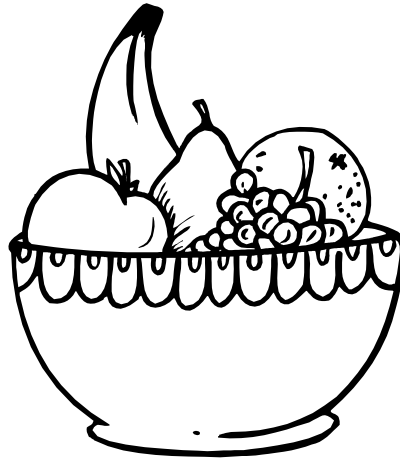

• FRUTTA

• QUADRO

• BRILLANTE

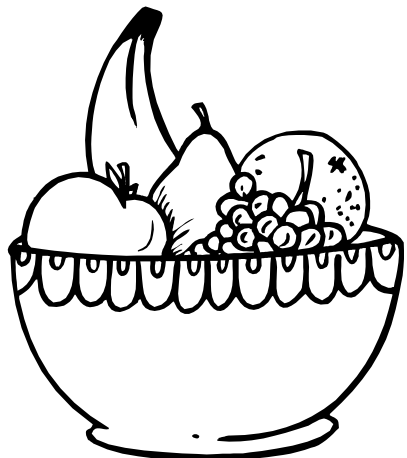

- frutta

- quadro

- brillante



- QUADRO
- BRILLANTE
- PRURITO



- quadro

- brillante

- prurito

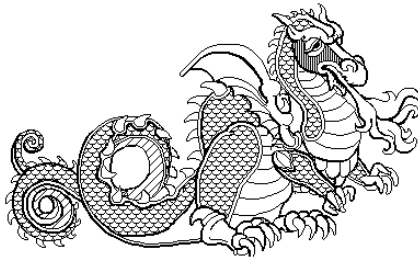

- BRILLANTE

- PRURITO

- DRAGO

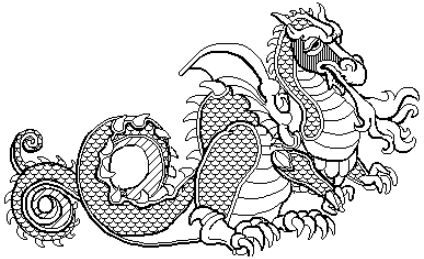

• brillante

• prurito

• drago

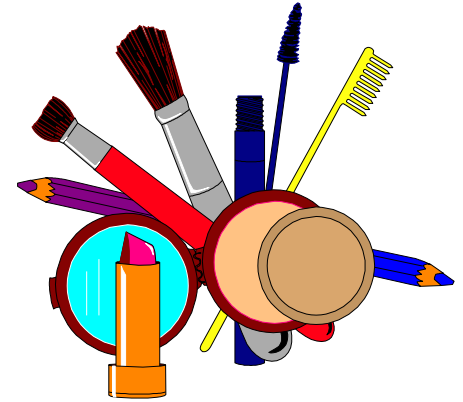
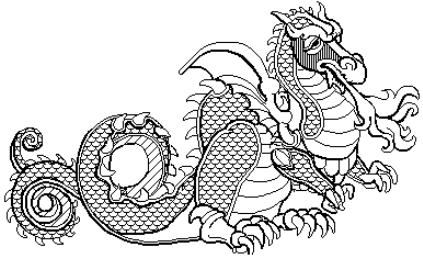

- PRURITO
- DRAGO
- TRUCCO

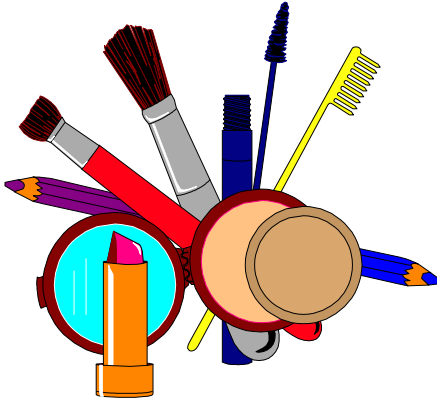
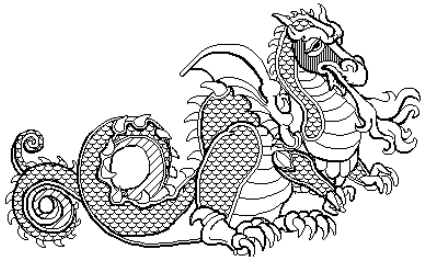

- prurito

- drago

- trucco

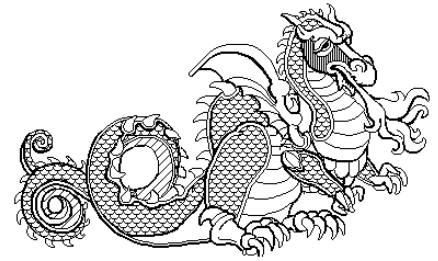
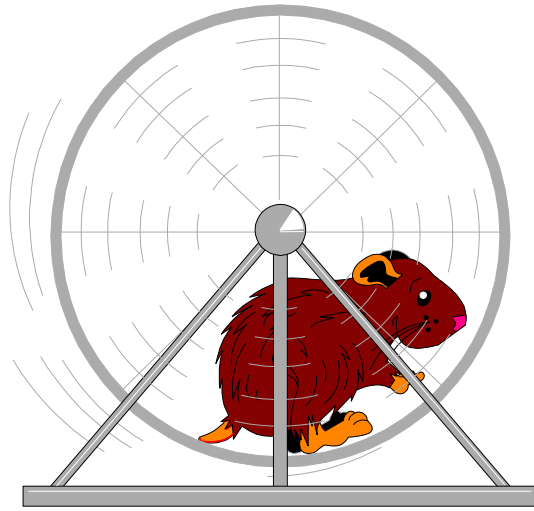
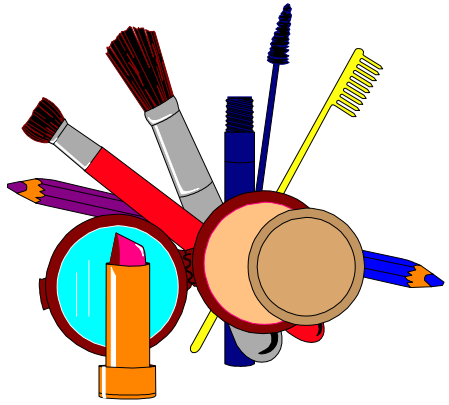

- DRAGO

- TRUCCO

- CRICETO

LETTURA SILLABICO-FONEMATICA

Far leggere e associare ogni parola all'immagine corrispondente.

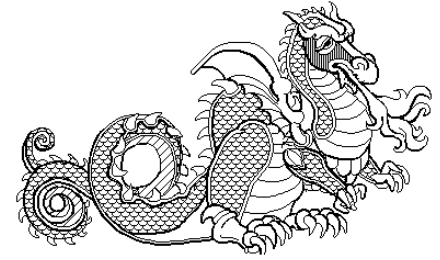
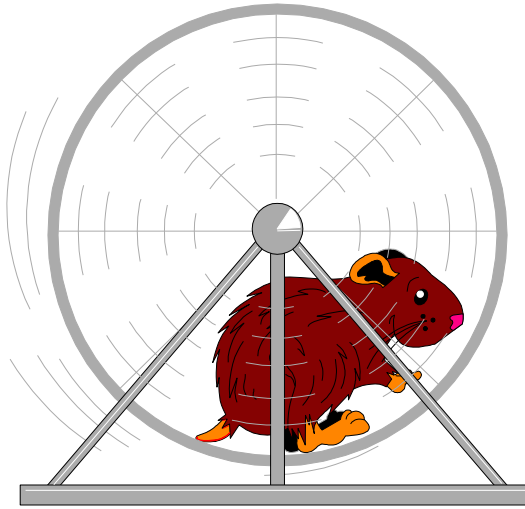
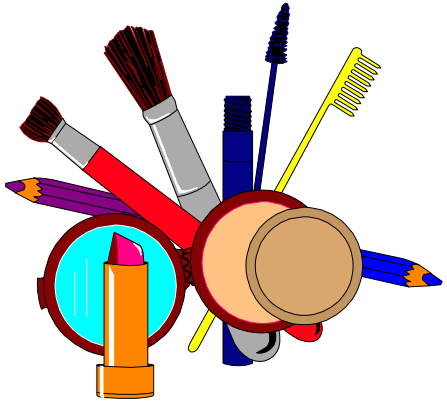

- drago

- trucco

- criceto

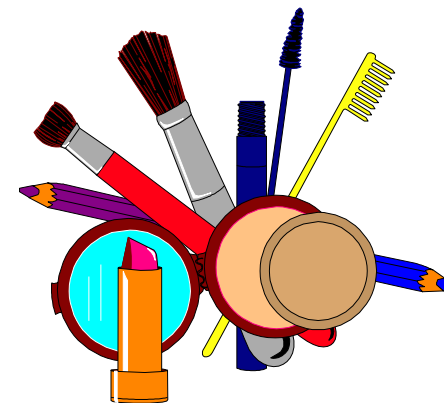
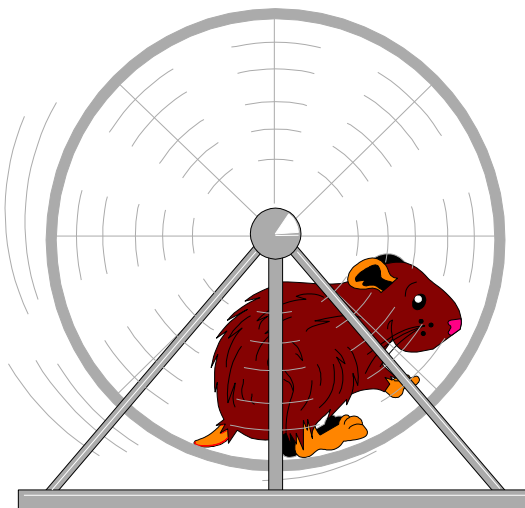

- TRUCCO
- CRICETO
- BRETELLE

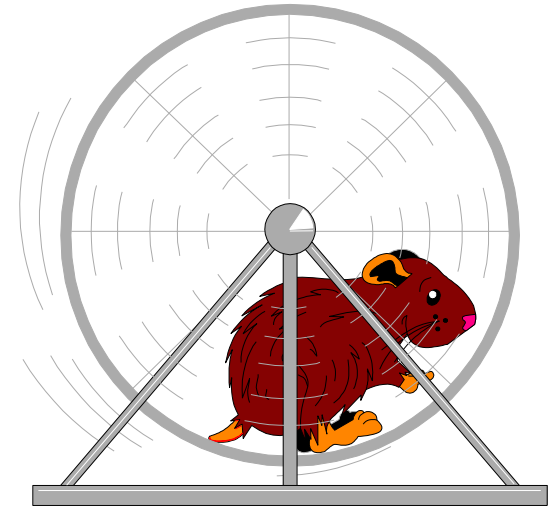
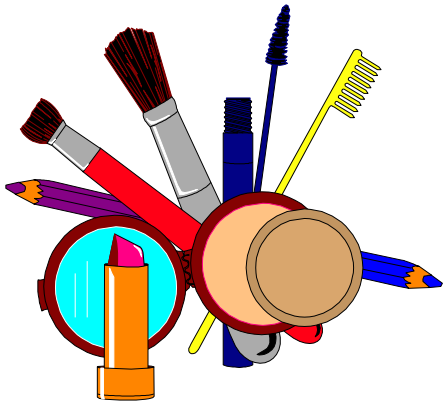

- **trucco**

- **criceto**

- **bretelle**

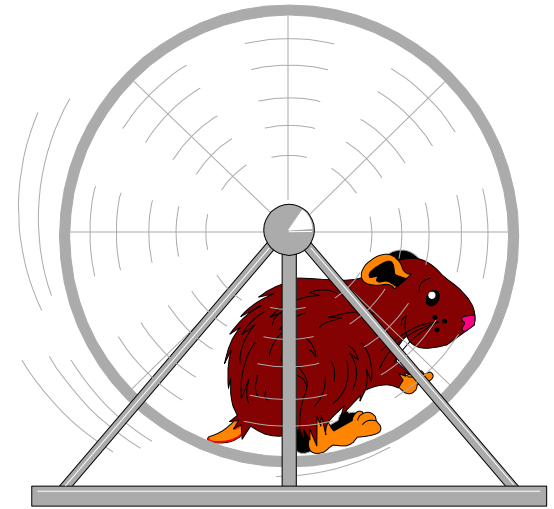

- CRICETO

- BRETELLE

- BROCCA

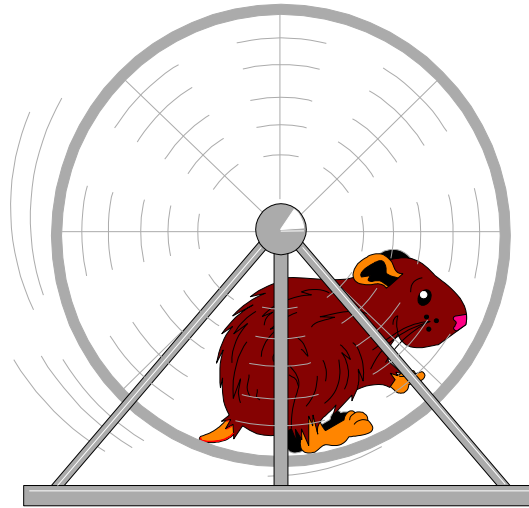

- criceto

- bretelle

- brocca

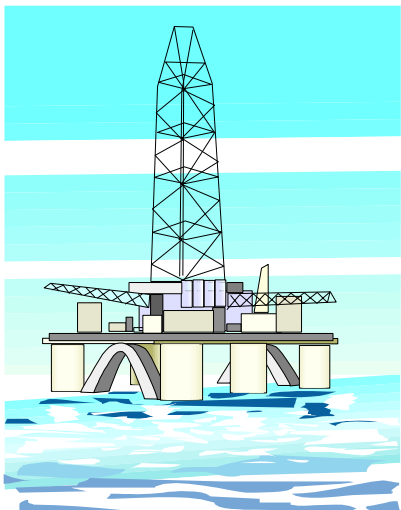

- BRETELLE

- BROCCA

- TRIVELLA

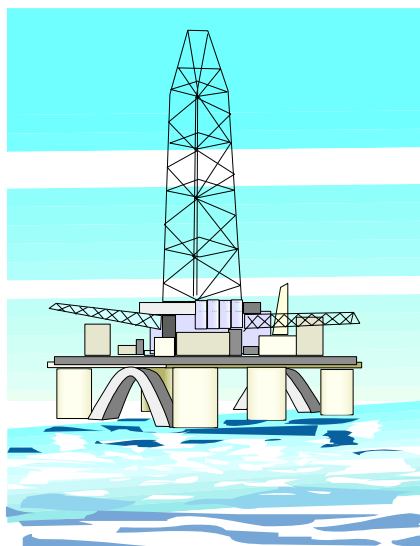

- bretelle

- brocca

- trivella

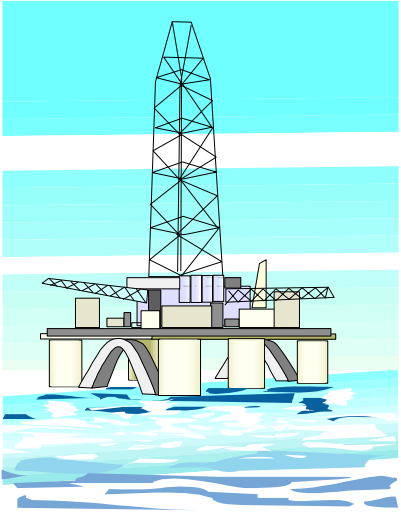

- BROCCA
- TRIVELLA
- ISTRICE

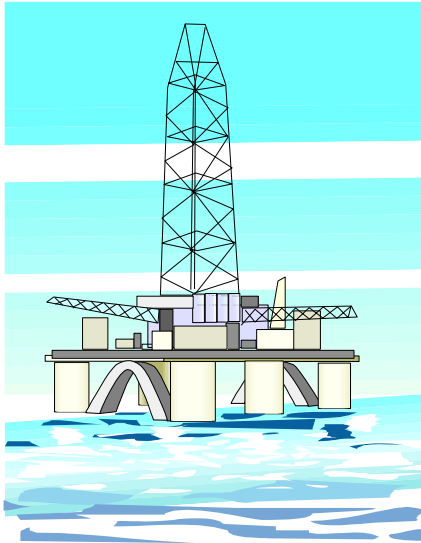

- brocca

- trivella

- istrice

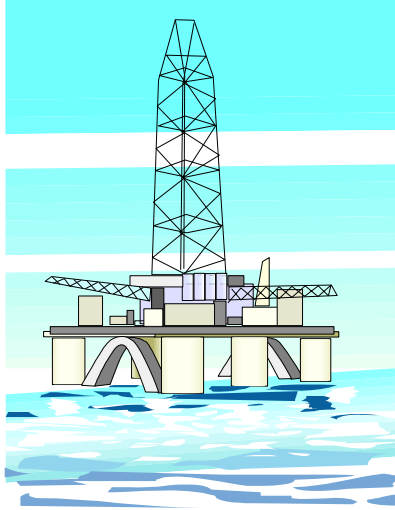
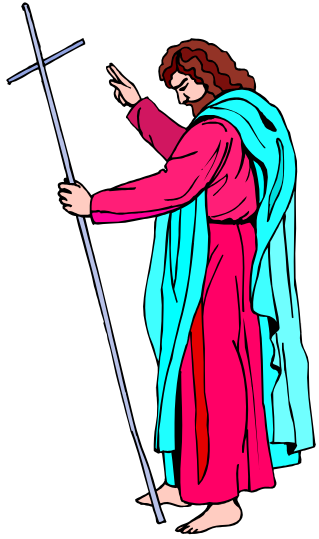

- TRIVELLA
- ISTRICE
- CRISTO

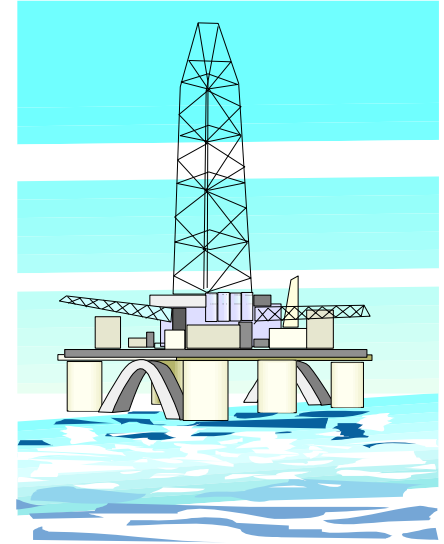
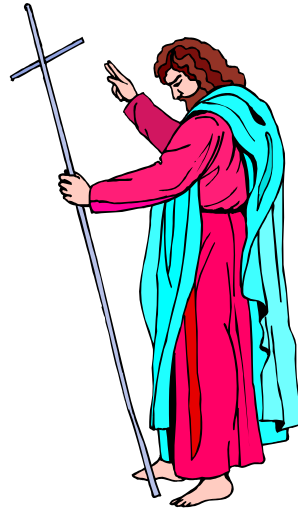

- trivella

- istrice

- Cristo

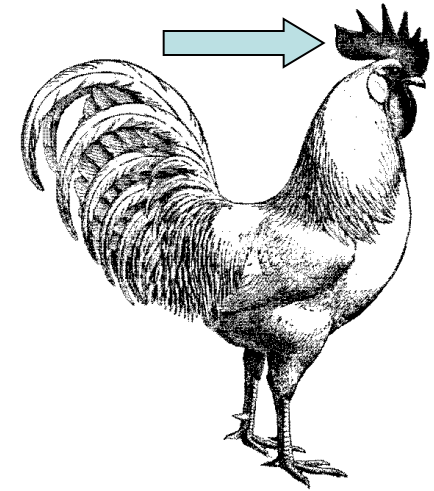
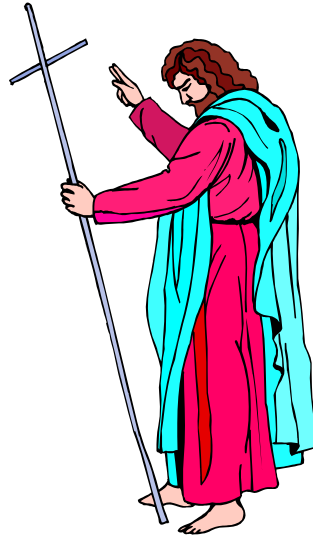

- ISTRICE

- CRISTO

- CRESTA

LETTURA SILLABICO-FONEMATICA

Far leggere e associare ogni parola all'immagine corrispondente.

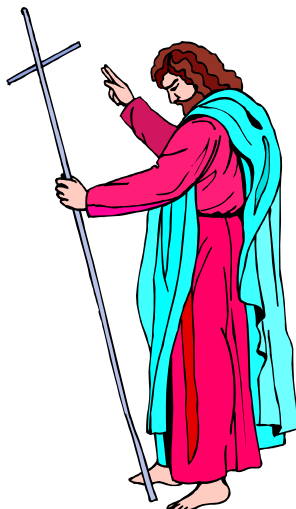
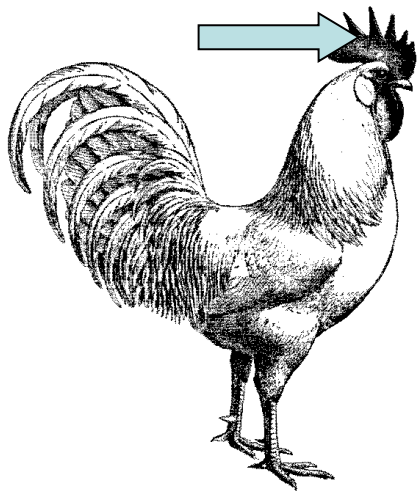

- istrice

- Cristo

- cresta

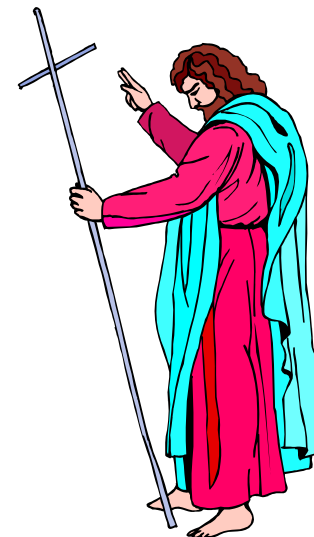
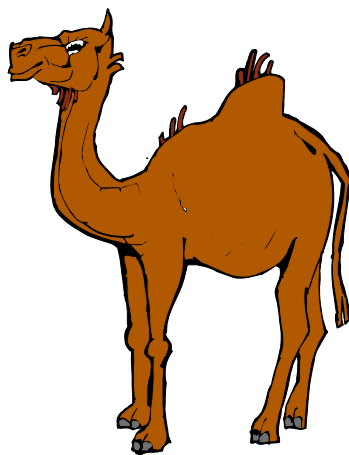
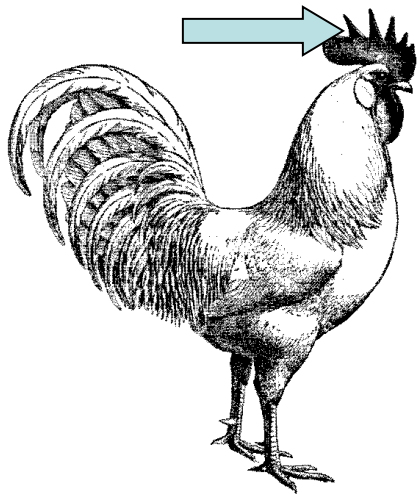

- CRISTO
- CRESTA
- DROMEDARIO

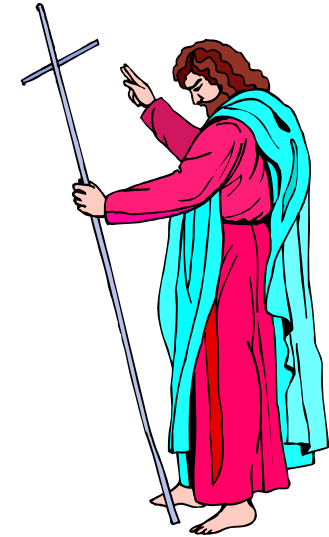
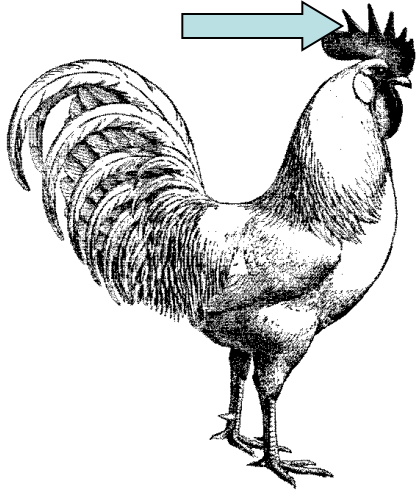
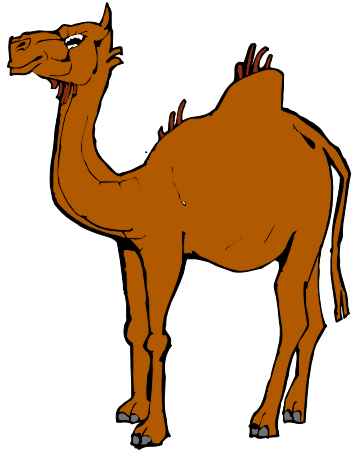

- Cristo
- cresta
- dromedario

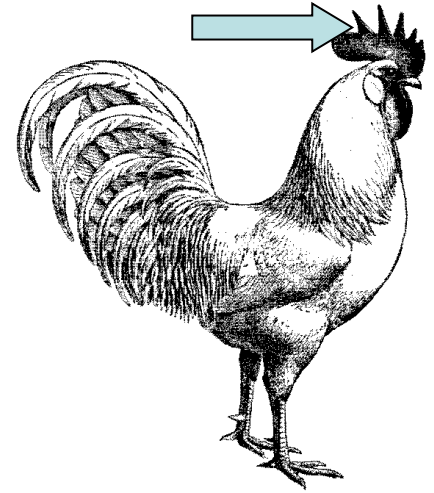
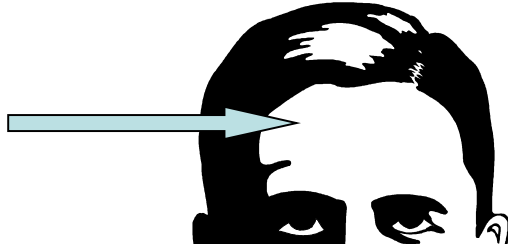
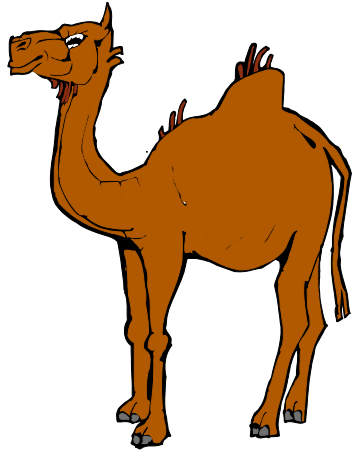

- CRESTA
- DROMEDARIO
- FRONTE

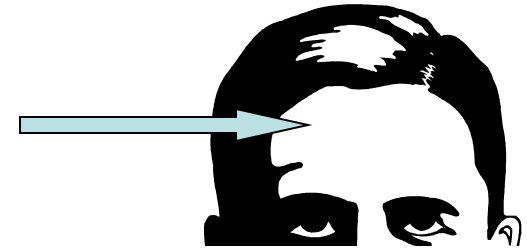
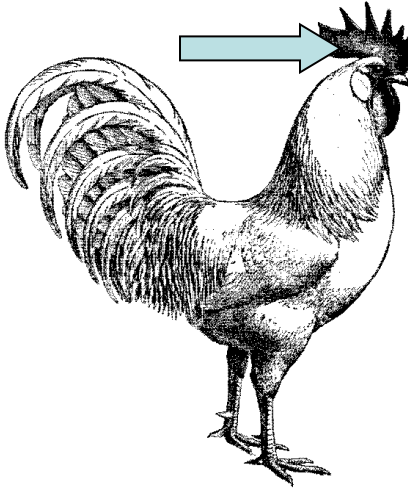
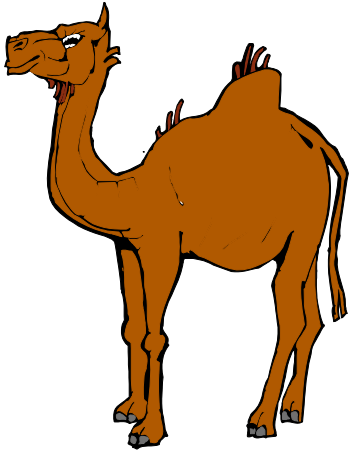

- cresta

- dromedario

- fronte

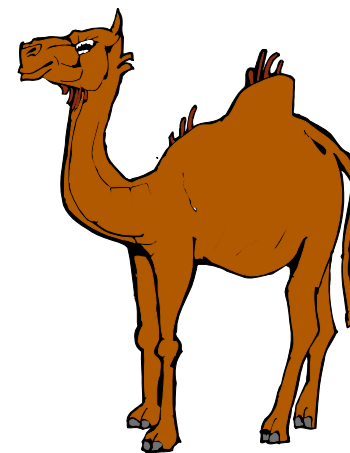
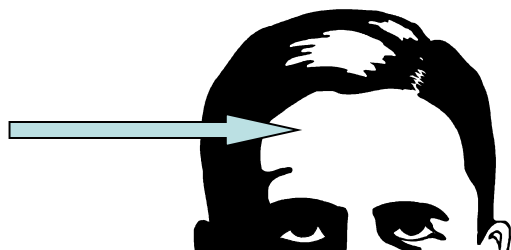
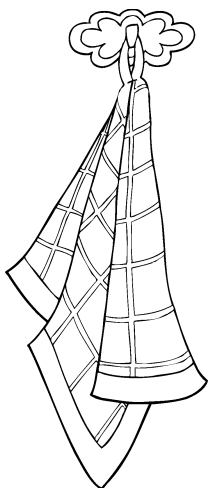

- DROMEDARIO
 - FRONTE
 - STROFINACCIO

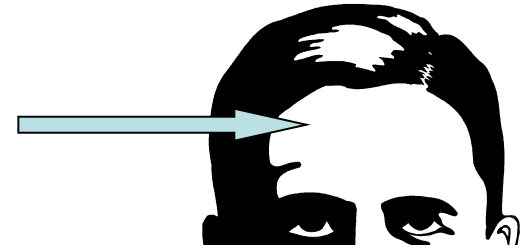
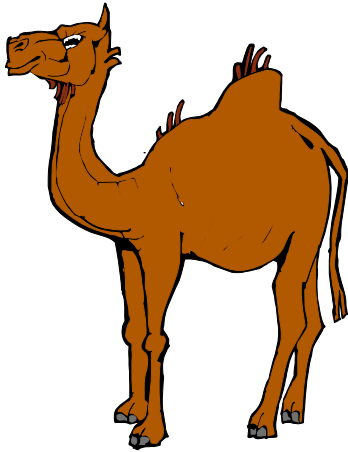
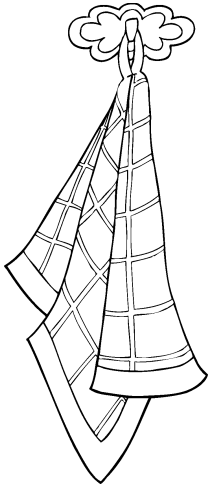

- dromedario
- fronte
- strofinaclo

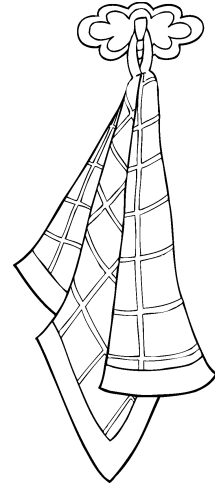
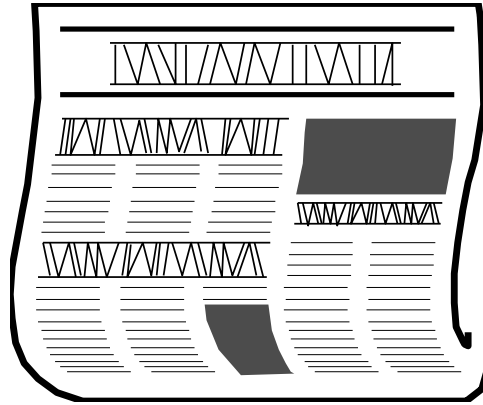
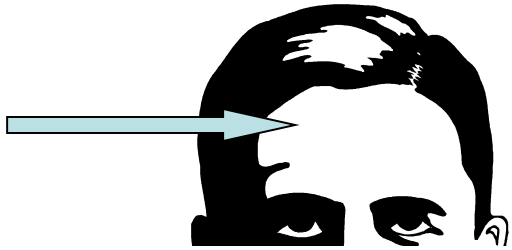

- FRONTE
 - STROFINACCIO
 - QUOTIDIANO

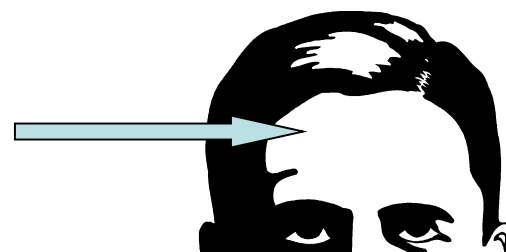
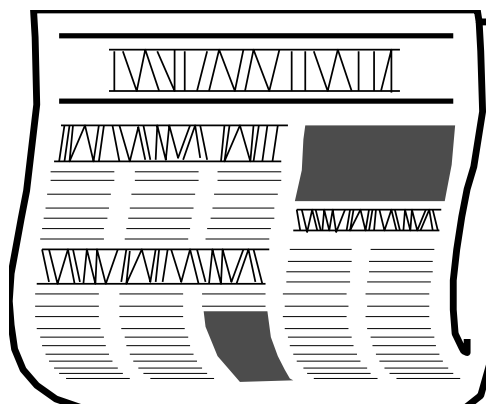
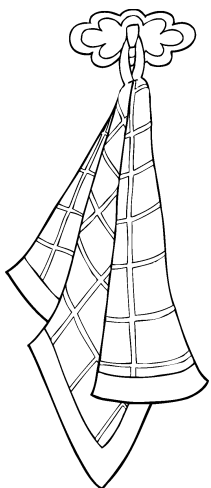

- fronte

- strofinaccio

- quotidiano

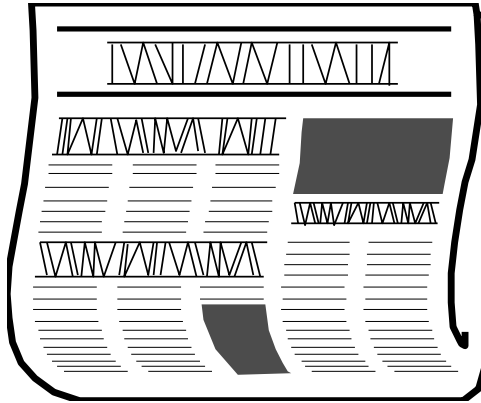
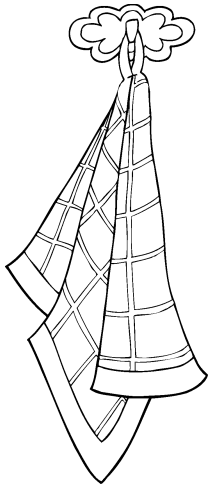

15

STRO

QUO

QUIN

LETTURA SILLABICO-FONEMATICA
Far associare ogni sillaba con la rispettiva immagine e viceversa.

15

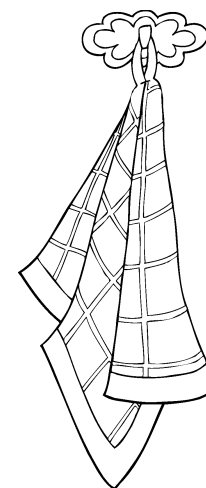
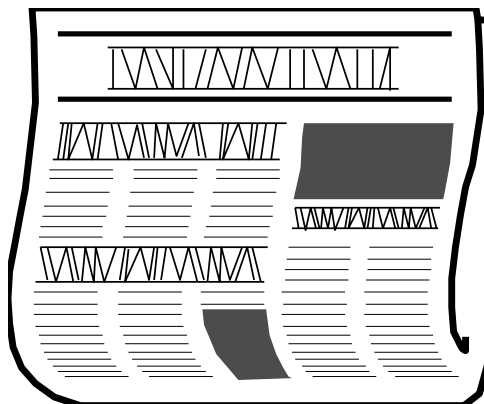

STRO

QUO

QUIN

LETTURA SILLABICO-FONEMATICA
Far associare ogni sillaba con la rispettiva immagine e viceversa.

15

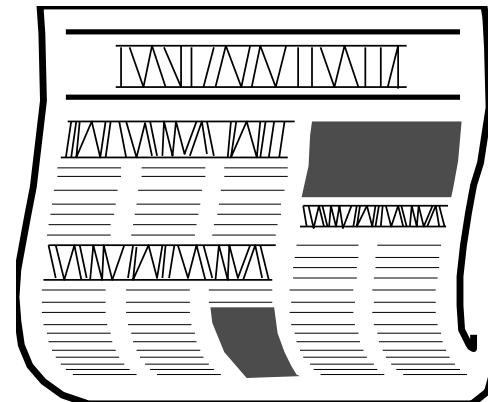
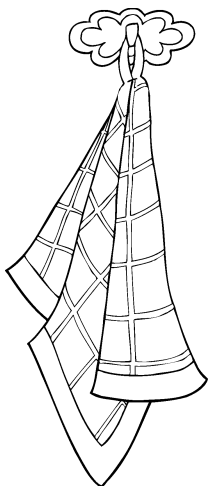

stro

quo

quin

LETTURA SILLABICO-FONEMATICA
Far associare ogni sillaba con la rispettiva immagine e viceversa.

15

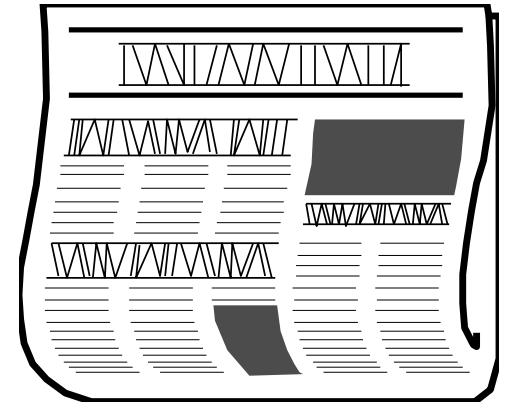

QUO

QUIN

FRE

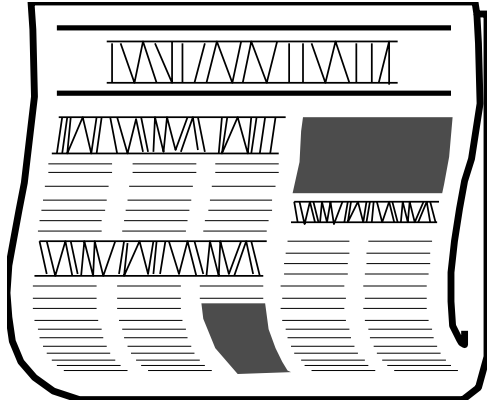

15



quo

quin

fre



QUERCIA



15

QUIN

FRE

QUER

LETTURA SILLABICO-FONEMATICA
Far associare ogni sillaba con la rispettiva immagine e viceversa.

15

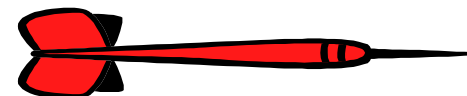

quin

fre

quer



STATUA

FRE

QUER

STA



STATUA



fre

quer

sta

LETTURA SILLABICO-FONEMATICA
Far associare ogni sillaba con la rispettiva immagine e viceversa.



STATUA



QUER

STA

TRO

LETTURA SILLABICO-FONEMICA
Far associare ogni sillaba con la rispettiva immagine e viceversa.



quer

sta

tro

LETTURA SILLABICO-FONEMATICA
Far associare ogni sillaba con la rispettiva immagine e viceversa.

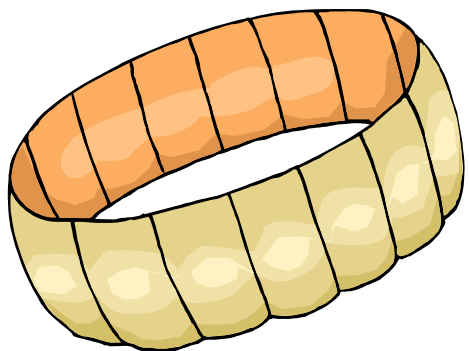

STA

TRO

BRA

LETTURA SILLABICO-FONEMATICA
Far associare ogni sillaba con la rispettiva immagine e viceversa.

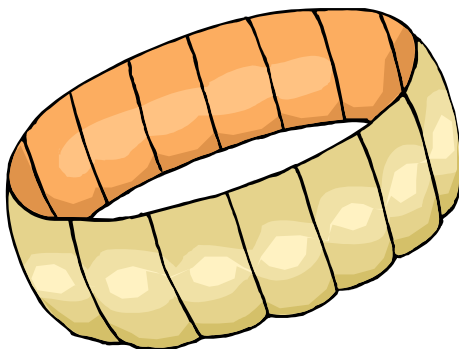

sta

tro

bra

LETTURA SILLABICO-FONEMATICA
Far associare ogni sillaba con la rispettiva immagine e viceversa.

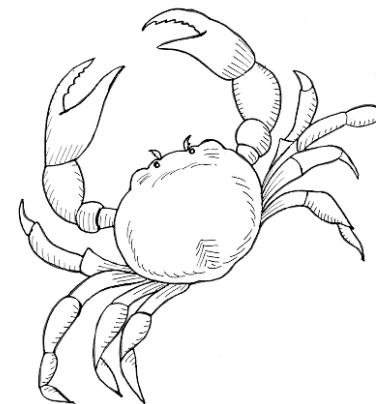
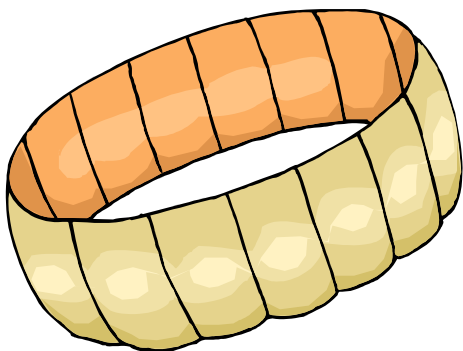

TRO

BRA

GRAN

LETTURA SILLABICO-FONEMATICA
Far associare ogni sillaba con la rispettiva immagine e viceversa.

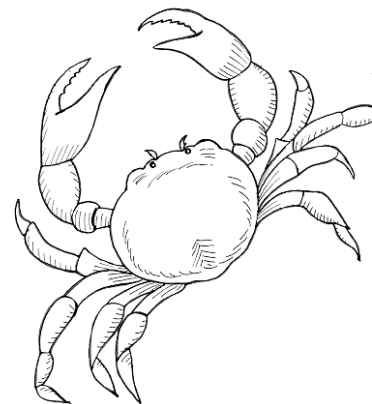
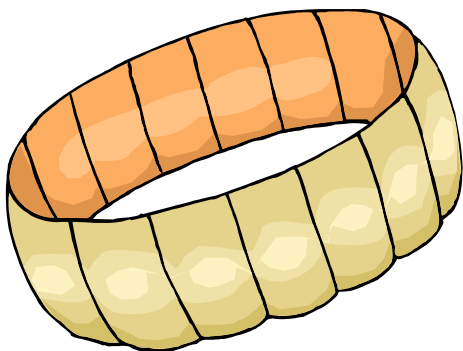

tro

bra

gran

LETTURA SILLABICO-FONEMATICA
Far associare ogni sillaba con la rispettiva immagine e viceversa.

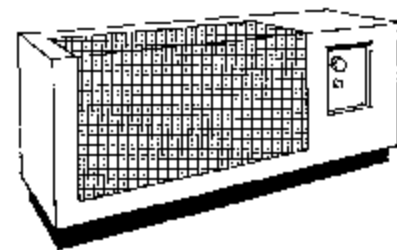
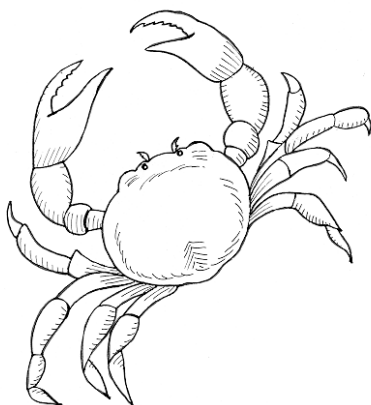
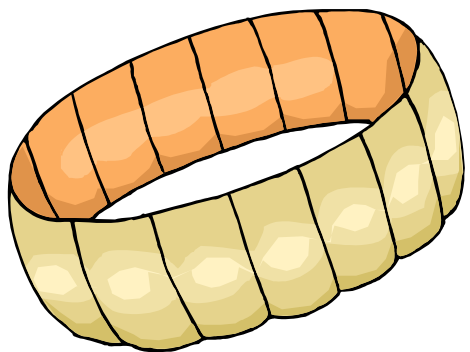

STUFA

BRA

GRAN

STU

LETTURA SILLABICO-FONEMATICA
Far associare ogni sillaba con la rispettiva immagine e viceversa.

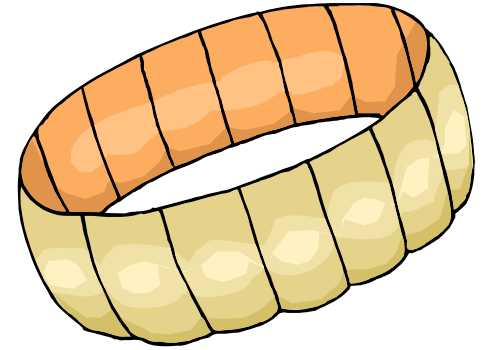
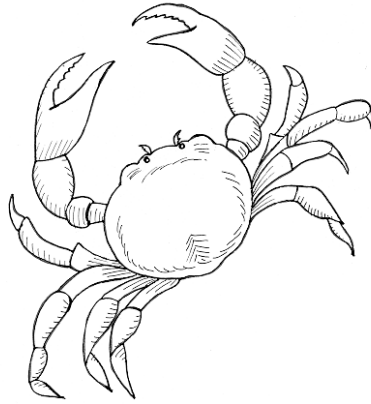
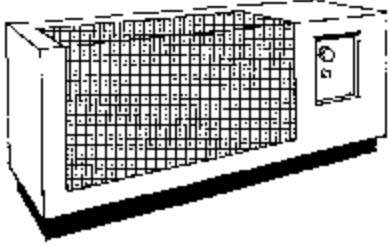

bra

gran

stu

LETTURA SILLABICO-FONEMATICA
Far associare ogni sillaba con la rispettiva immagine e viceversa.

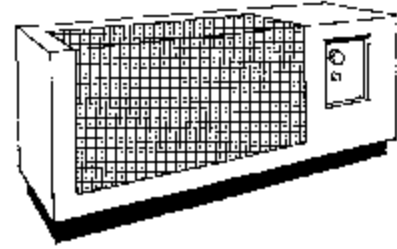
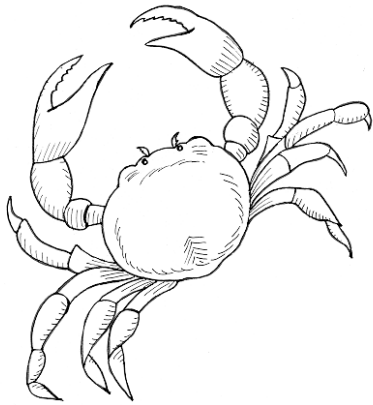
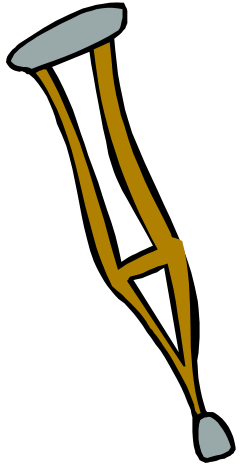

GRAN

STU

GRU

LETTURA SILLABICO-FONEMATICA
Far associare ogni sillaba con la rispettiva immagine e viceversa.

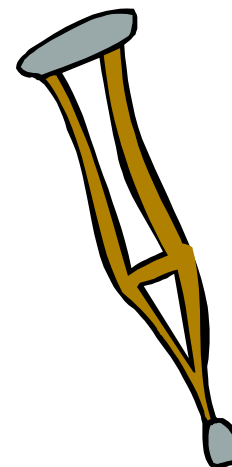
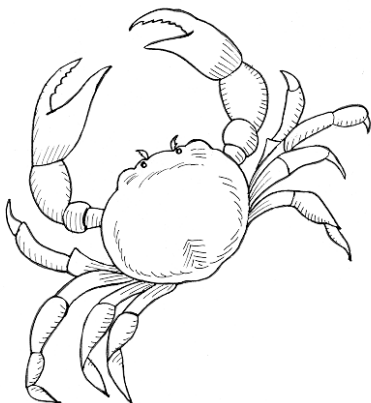
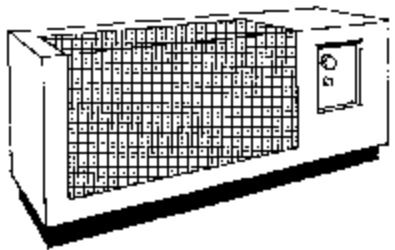

gran

stu

gru

LETTURA SILLABICO-FONEMATICA
Far associare ogni sillaba con la rispettiva immagine e viceversa.

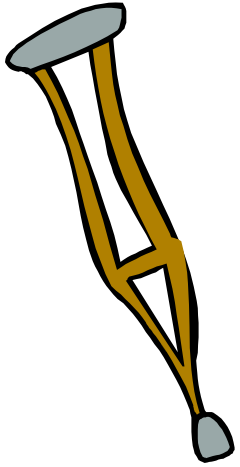

PRINCIPESSA

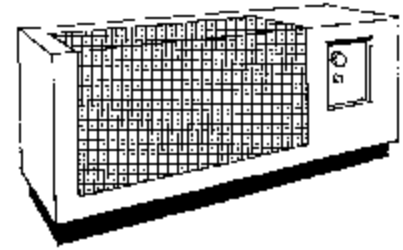

STU

GRU

PRIN

LETTURA SILLABICO-FONEMATICA
Far associare ogni sillaba con la rispettiva immagine e viceversa.

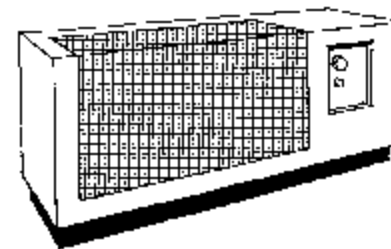
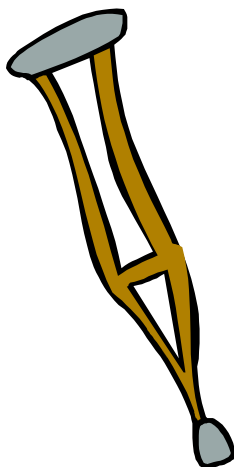

stu

gru

prin

LETTURA SILLABICO-FONEMATICA
Far associare ogni sillaba con la rispettiva immagine e viceversa.

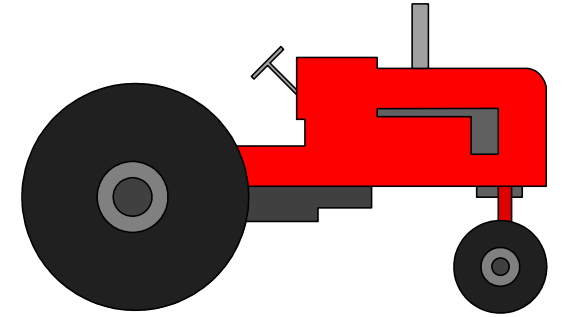
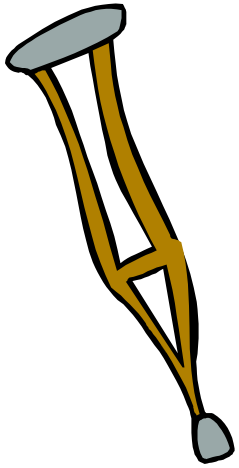

GRU

PRIN

TRA

LETTURA SILLABICO-FONEMATICA
Far associare ogni sillaba con la rispettiva immagine e viceversa.

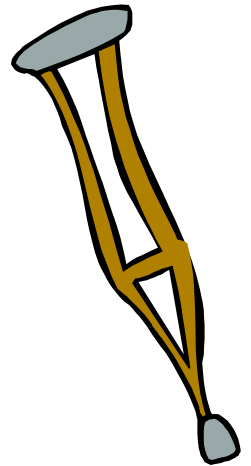
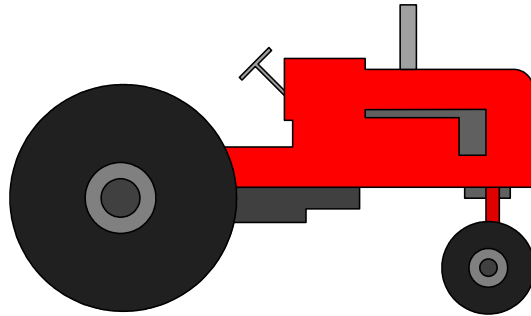

gru

prin

tra

LETTURA SILLABICO-FONEMATICA
Far associare ogni sillaba con la rispettiva immagine e viceversa.

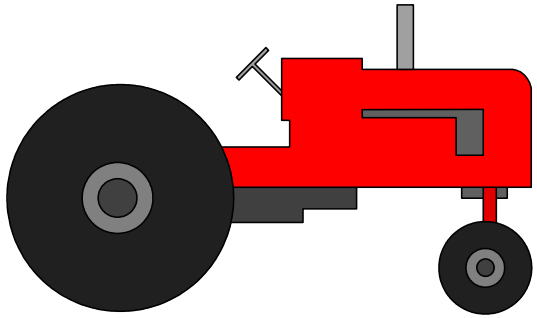

PRIN

TRA

CHI

LETTURA SILLABICO-FONEMATICA
Far associare ogni sillaba con la rispettiva immagine e viceversa.

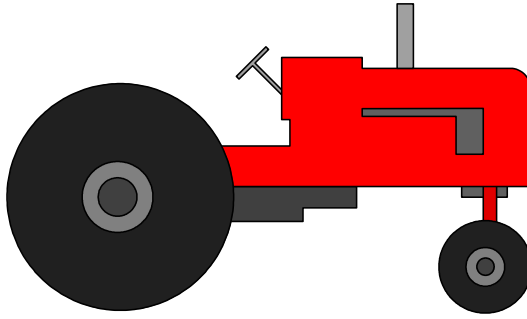

prin

tra

chi

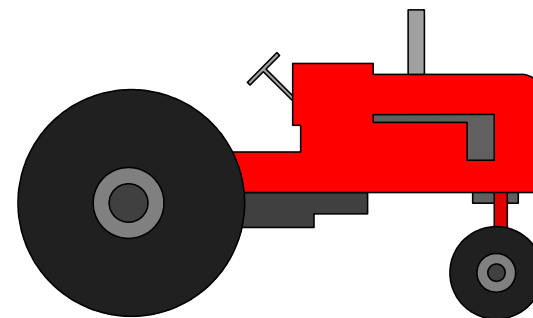

TRA

CHI

SCA

LETTURA SILLABICO-FONEMATICA
Far associare ogni sillaba con la rispettiva immagine e viceversa.

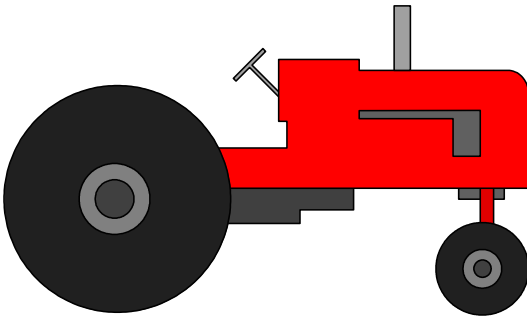

tra

chi

sca



CHI

SCA

SPO

LETTURA SILLABICO-FONEMATICA
Far associare ogni sillaba con la rispettiva immagine e viceversa.



chi

sca

spo

LETTURA SILLABICO-FONEMATICA
Far associare ogni sillaba con la rispettiva immagine e viceversa.

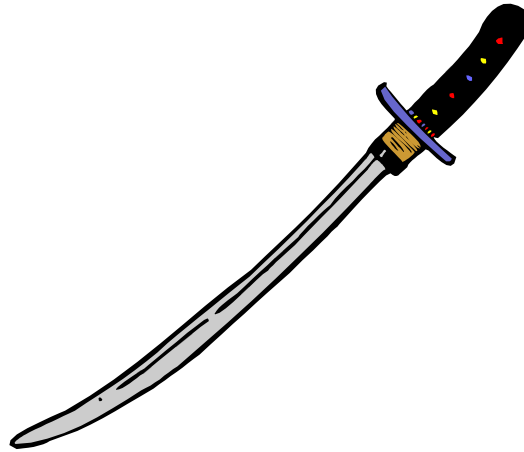

SCA

SPO

SPA

LETTURA SILLABICO-FONEMATICA
Far associare ogni sillaba con la rispettiva immagine e viceversa.

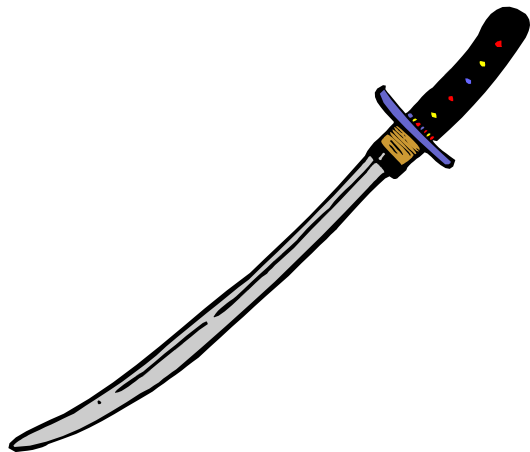

sca

spo

spa

LETTURA SILLABICO-FONEMATICA
Far associare ogni sillaba con la rispettiva immagine e viceversa.

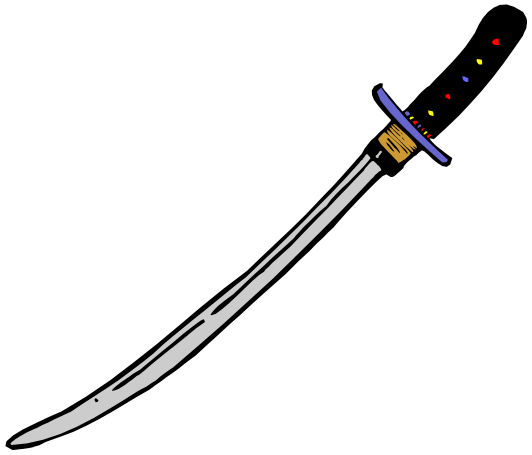

GNOMO



SPO

SPA

GNO

LETTURA SILLABICO-FONEMATICA
Far associare ogni sillaba con la rispettiva immagine e viceversa.

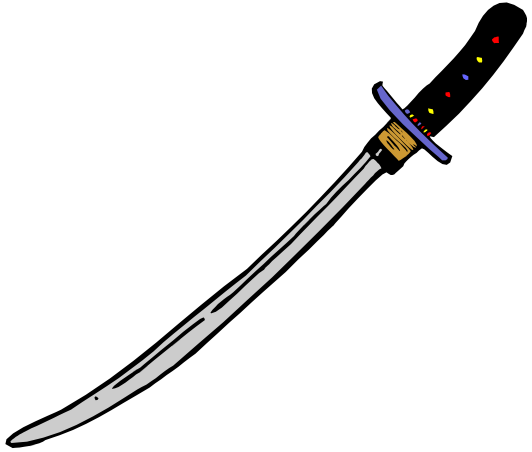

spo

spa

gno

LETTURA SILLABICO-FONEMATICA
Far associare ogni sillaba con la rispettiva immagine e viceversa.

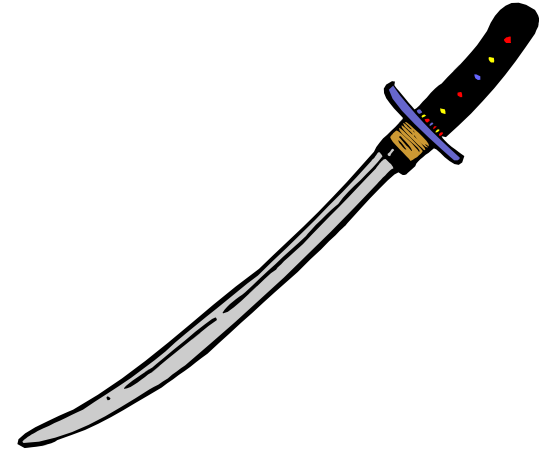
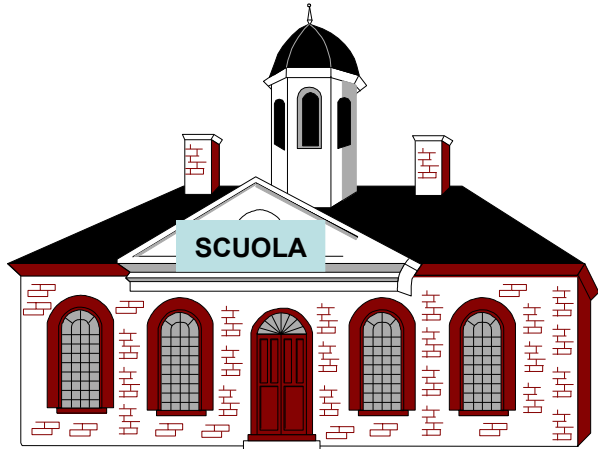

SPA

GNO

SCU

LETTURA SILLABICO-FONEMATICA
Far associare ogni sillaba con la rispettiva immagine e viceversa.

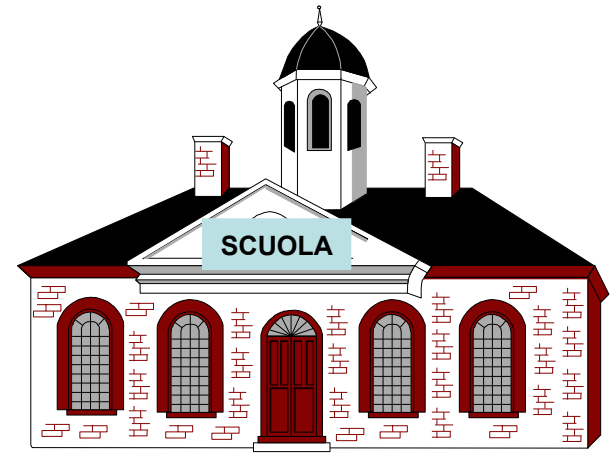
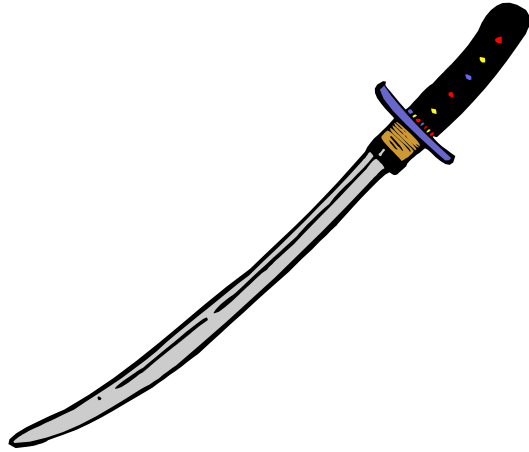

spa

gno

scu

LETTURA SILLABICO-FONEMATICA
Far associare ogni sillaba con la rispettiva immagine e viceversa.

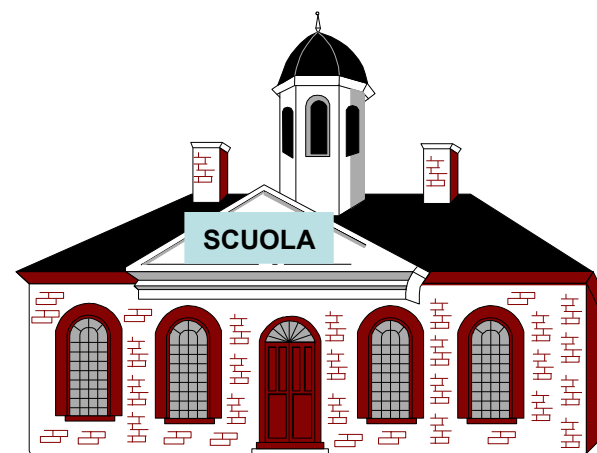
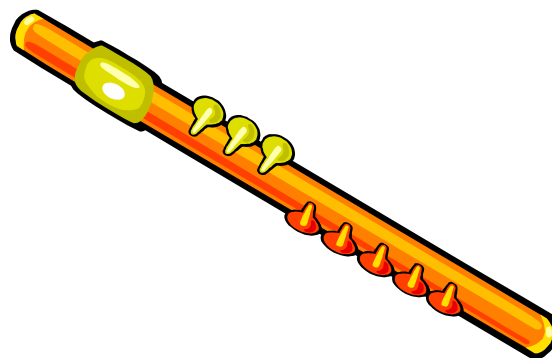

GNO

SCU

FLA

LETTURA SILLABICO-FONEMATICA
Far associare ogni sillaba con la rispettiva immagine e viceversa.

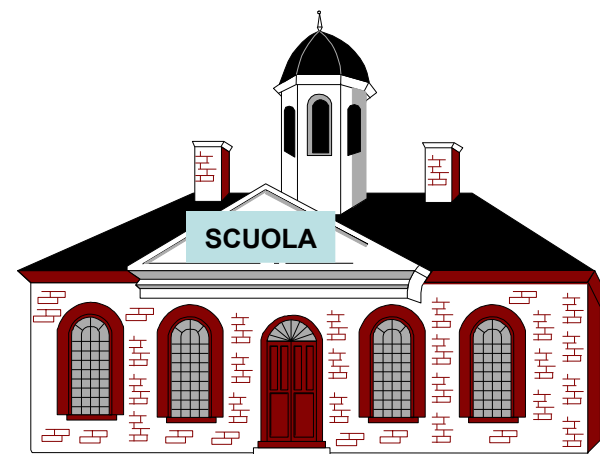
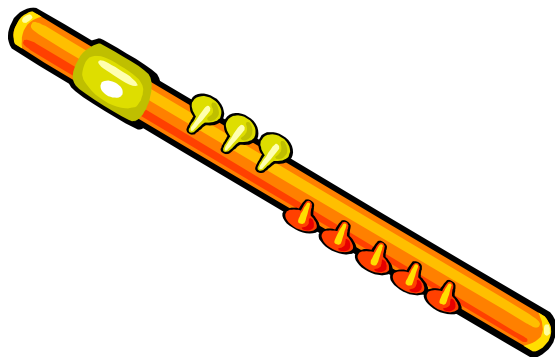

gno

scu

fla

LETTURA SILLABICO-FONEMATICA
Far associare ogni sillaba con la rispettiva immagine e viceversa.

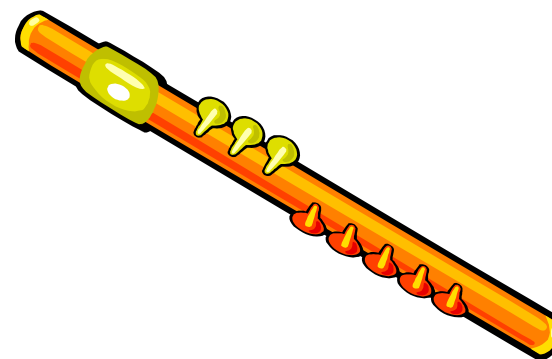
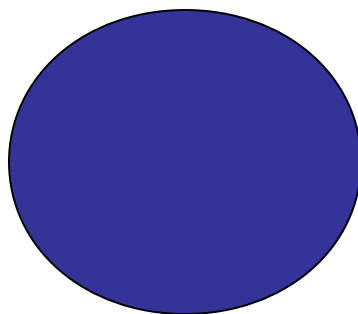
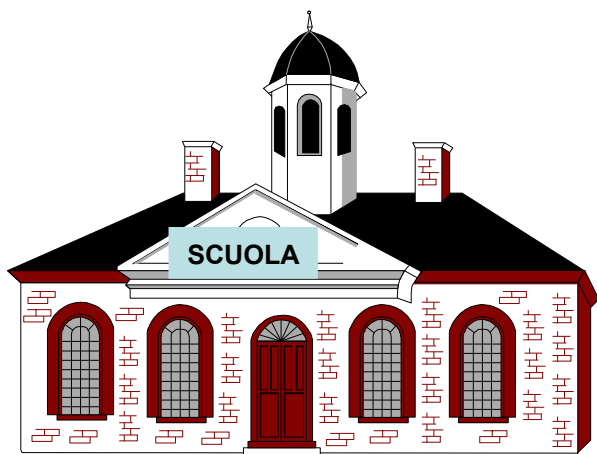

SCU

FLA

BLU

LETTURA SILLABICO-FONEMATICA
Far associare ogni sillaba con la rispettiva immagine e viceversa.

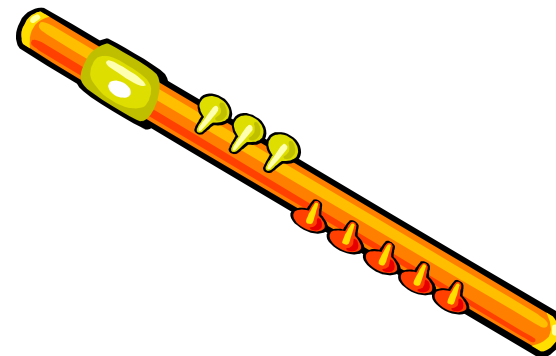
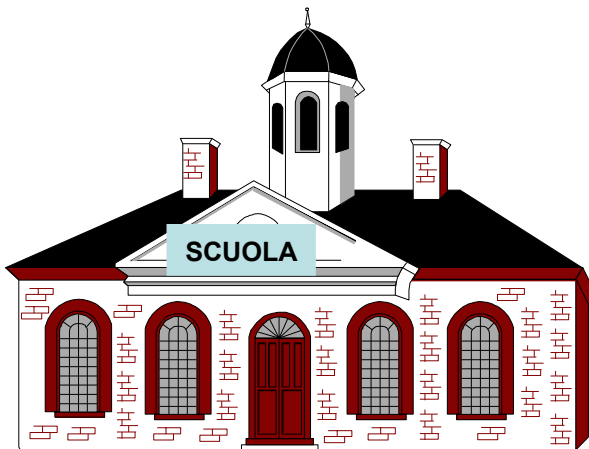
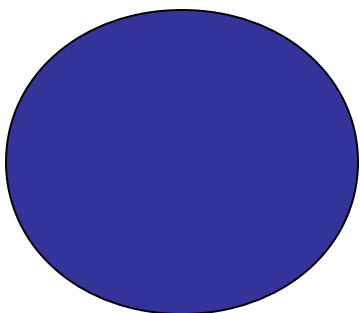

scu

fla

blu

LETTURA SILLABICO-FONEMATICA
Far associare ogni sillaba con la rispettiva immagine e viceversa.

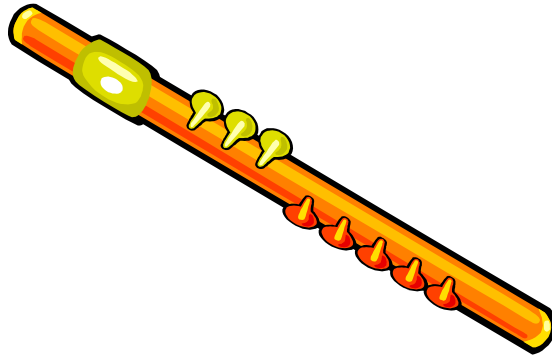
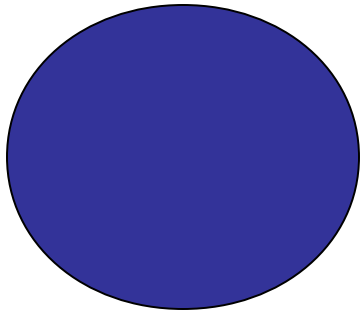

FLA

BLU

SCE

LETTURA SILLABICO-FONEMATICA
Far associare ogni sillaba con la rispettiva immagine e viceversa.

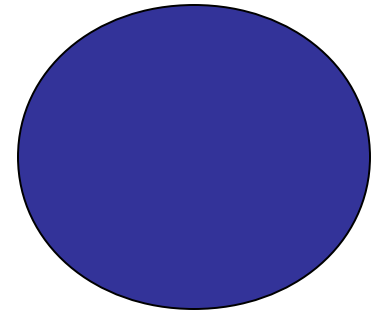
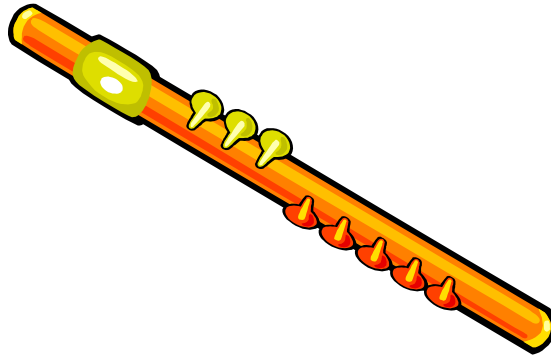

fla

blu

sce

LETTURA SILLABICO-FONEMATICA
Far associare ogni sillaba con la rispettiva immagine e viceversa.

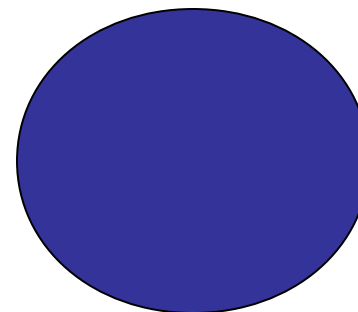
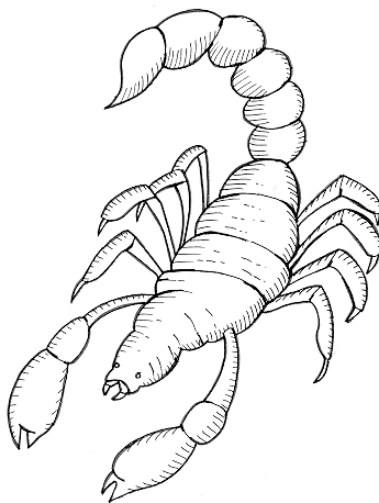

BLU

SCE

SCO

LETTURA SILLABICO-FONEMATICA
Far associare ogni sillaba con la rispettiva immagine e viceversa.

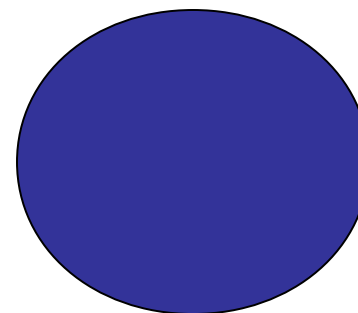
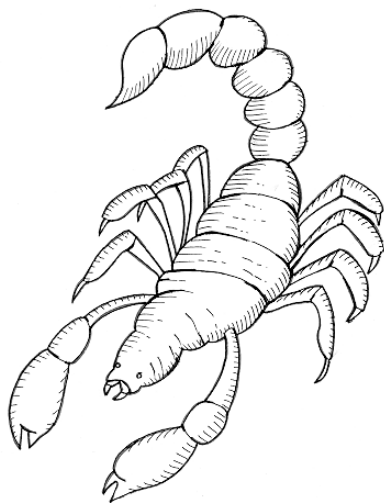

blu

sce

sco

LETTURA SILLABICO-FONEMATICA
Far associare ogni sillaba con la rispettiva immagine e viceversa.

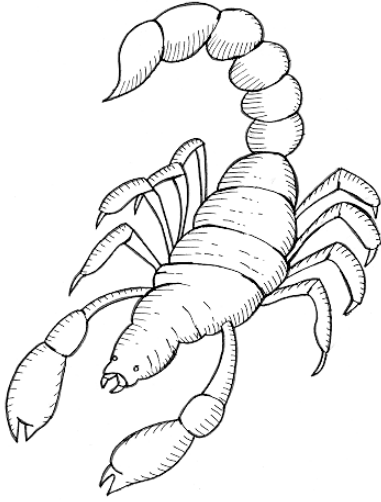
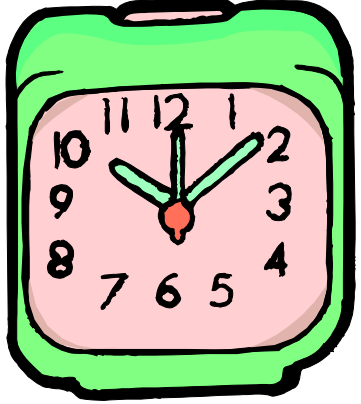

SCE

SCO

SVE

LETTURA SILLABICO-FONEMATICA
Far associare ogni sillaba con la rispettiva immagine e viceversa.

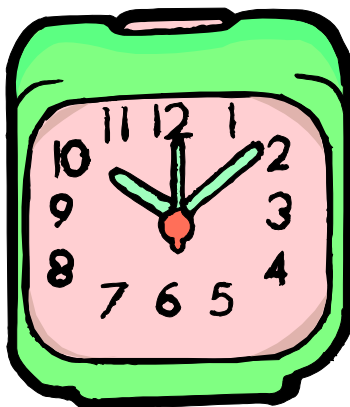
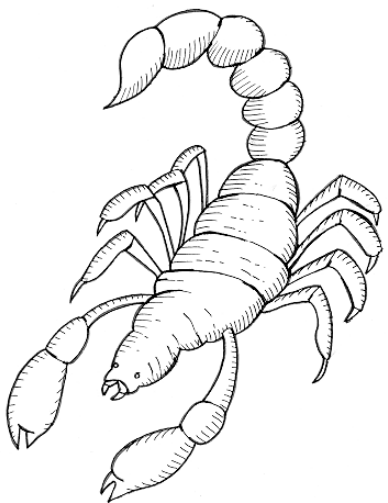

sce

sco

sve

LETTURA SILLABICO-FONEMATICA
Far associare ogni sillaba con la rispettiva immagine e viceversa.

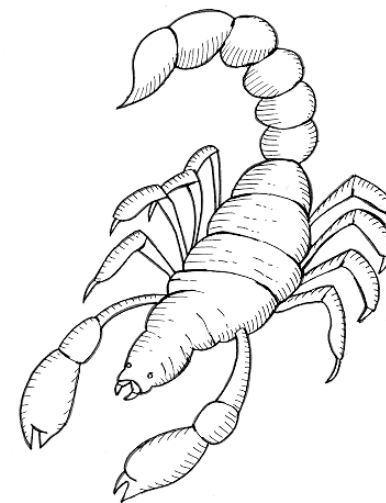
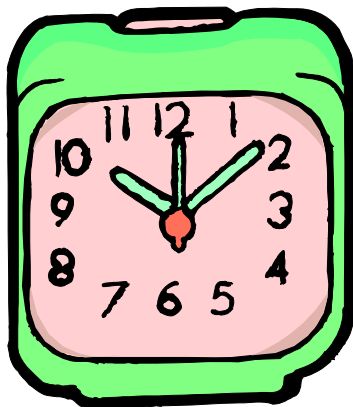
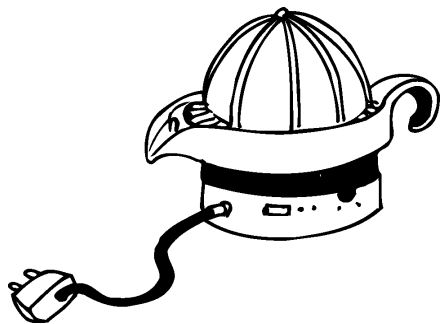

SCO

SVE

SPRE

LETTURA SILLABICO-FONEMATICA
Far associare ogni sillaba con la rispettiva immagine e viceversa.

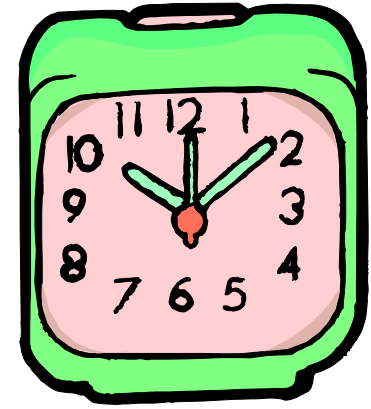
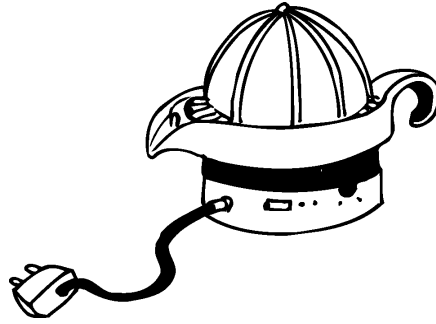
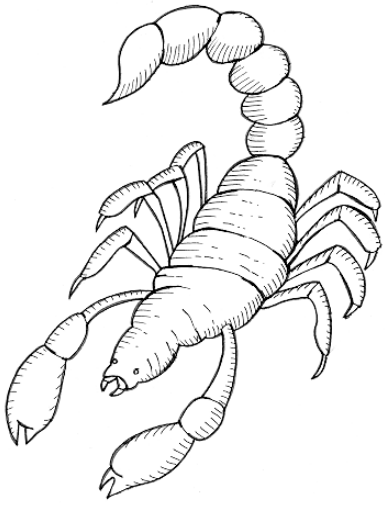

sco

sve

spre

LETTURA SILLABICO-FONEMATICA
Far associare ogni sillaba con la rispettiva immagine e viceversa.

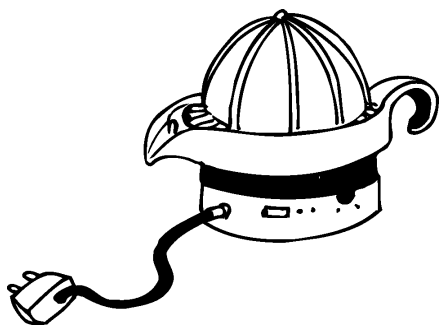

SPREMIAGRUMI

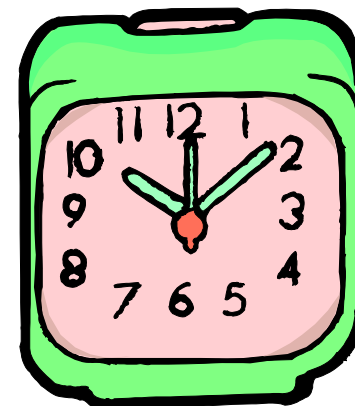

SVE

SPRE

SLI

LETTURA SILLABICO-FONEMATICA
Far associare ogni sillaba con la rispettiva immagine e viceversa.

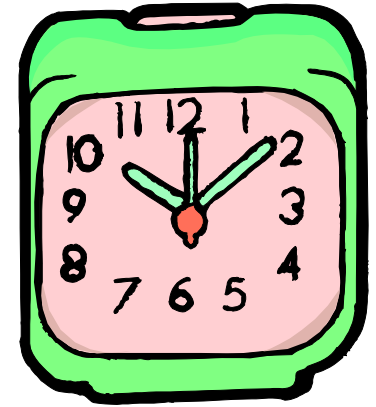
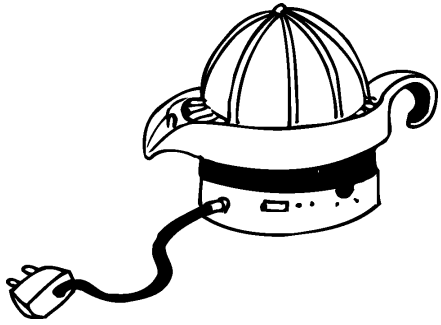

sve

spre

sli

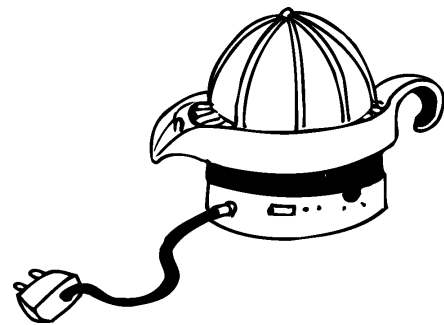
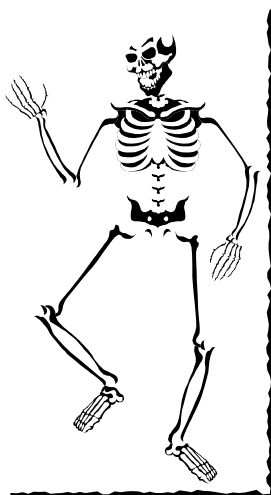
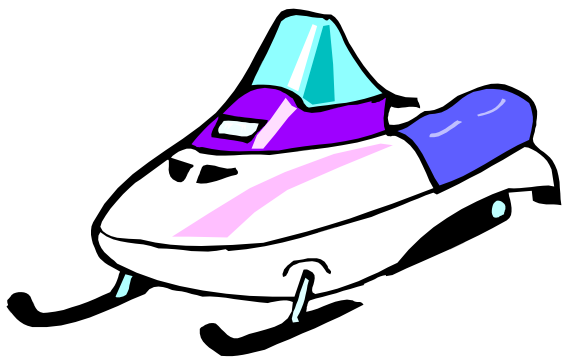

SPRE

SLI

SCHE

LETTURA SILLABICO-FONEMATICA
Far associare ogni sillaba con la rispettiva immagine e viceversa.

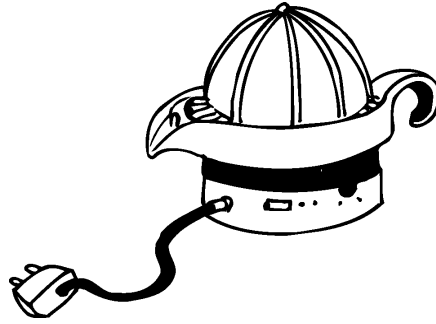
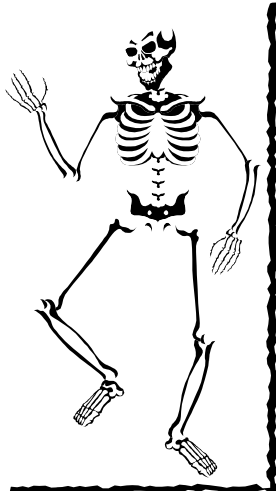

spre

sli

sche

LETTURA SILLABICO-FONEMATICA
Far associare ogni sillaba con la rispettiva immagine e viceversa.

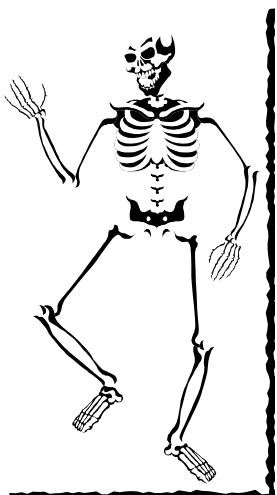

SLI

SCHE

PIN

LETTURA SILLABICO-FONEMATICA
Far associare ogni sillaba con la rispettiva immagine e viceversa.

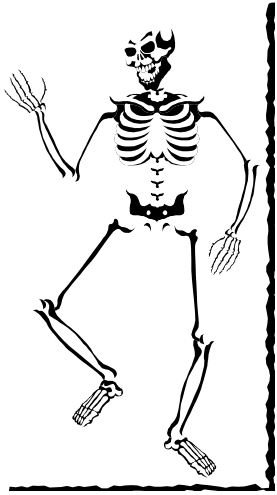

sli

sche

pin

LETTURA SILLABICO-FONEMATICA
Far associare ogni sillaba con la rispettiva immagine e viceversa.

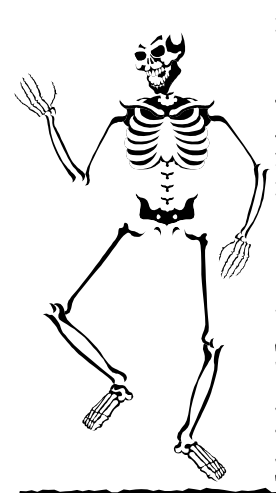
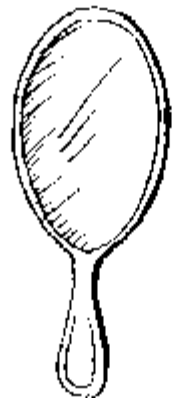
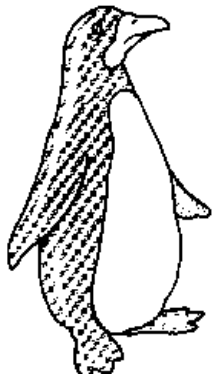

SCHE

PIN

SPE

LETTURA SILLABICO-FONEMATICA
Far associare ogni sillaba con la rispettiva immagine e viceversa.

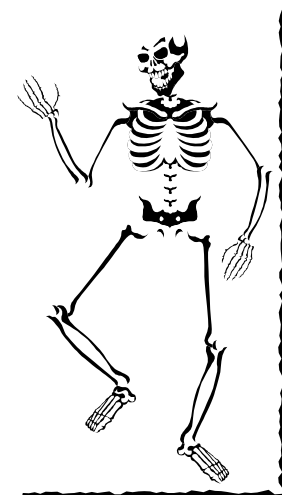
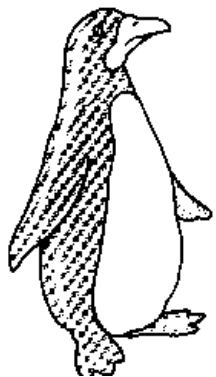

sche

pin

spe

LETTURA SILLABICO-FONEMATICA
Far associare ogni sillaba con la rispettiva immagine e viceversa.

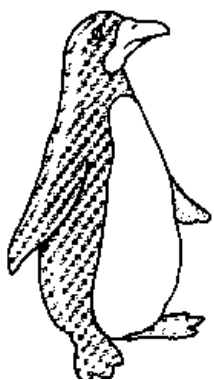

PIN

SPE

GRO

LETTURA SILLABICO-FONEMATICA
Far associare ogni sillaba con la rispettiva immagine e viceversa.

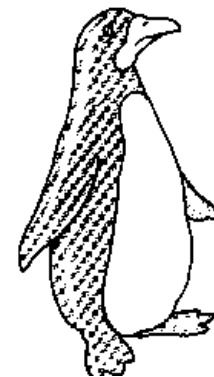
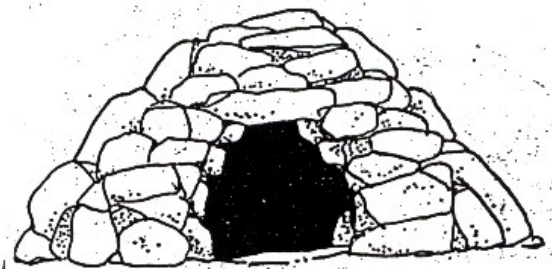

pin

spe

gro

LETTURA SILLABICO-FONEMATICA
Far associare ogni sillaba con la rispettiva immagine e viceversa.

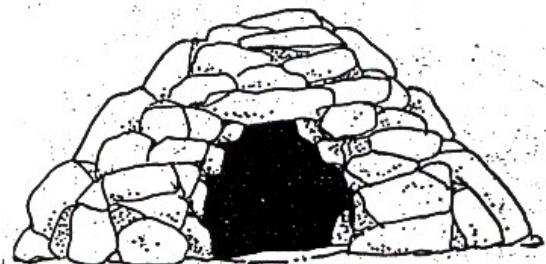
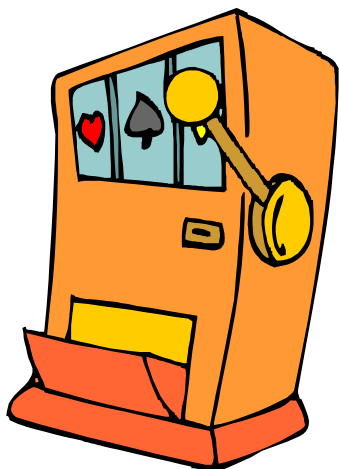

SPE

GRO

SLOT

LETTURA SILLABICO-FONEMATICA
Far associare ogni sillaba con la rispettiva immagine e viceversa.

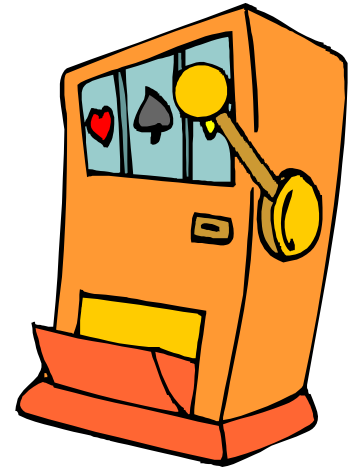
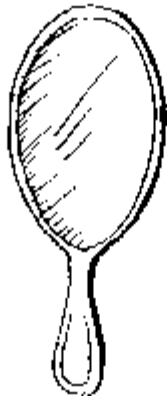
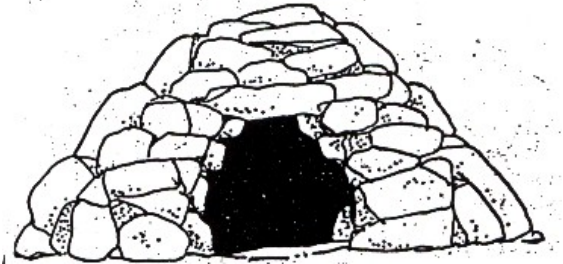

spe

gro

slot

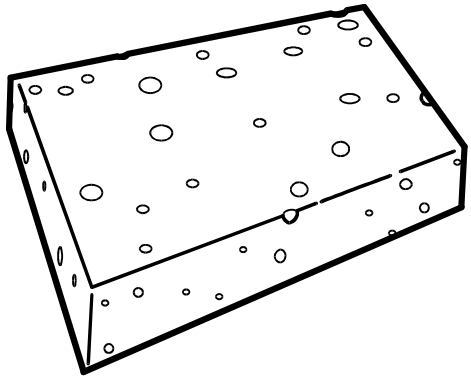

SPUGNA

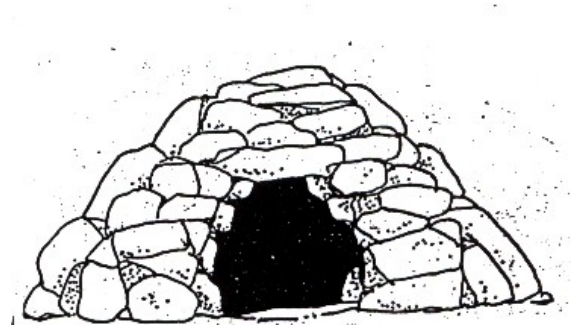
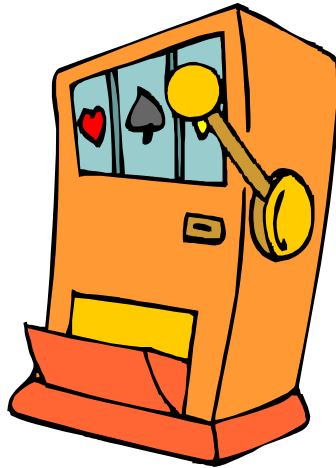

GRO

SLOT

SPU

LETTURA SILLABICO-FONEMATICA
Far associare ogni sillaba con la rispettiva immagine e viceversa.

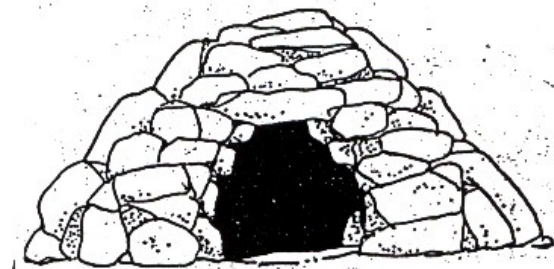
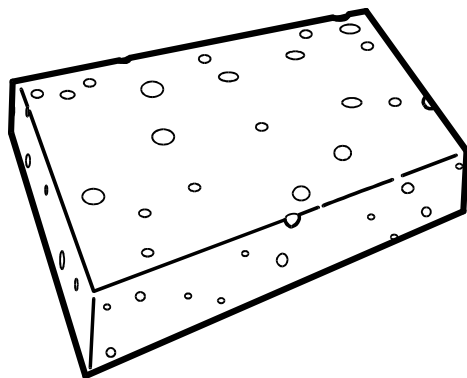
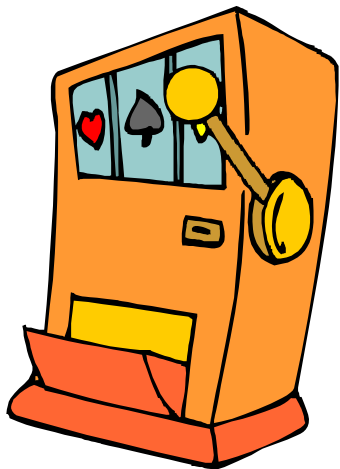

gro

slot

spu

LETTURA SILLABICO-FONEMATICA
Far associare ogni sillaba con la rispettiva immagine e viceversa.

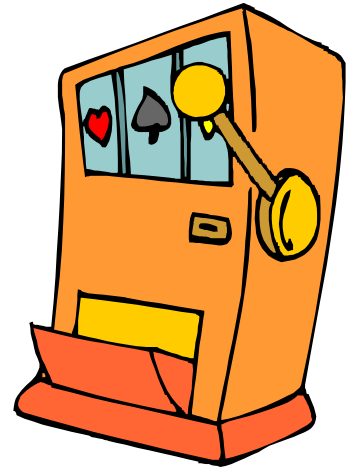
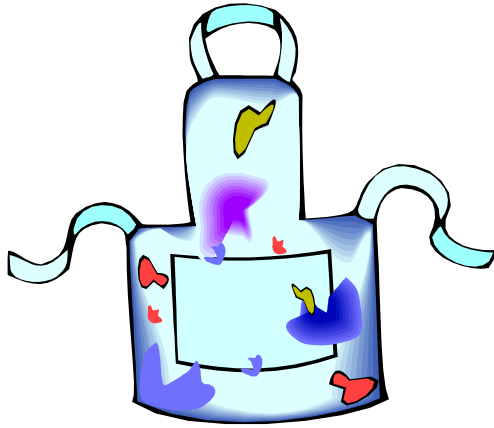
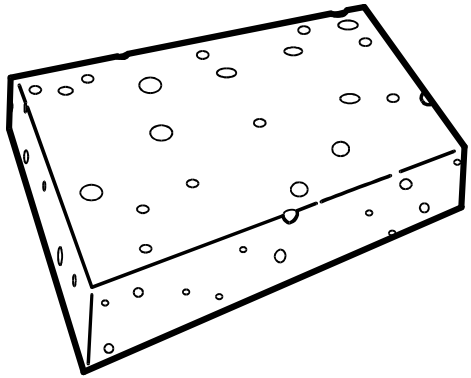

SLOT

SPU

GREM

LETTURA SILLABICO-FONEMATICA
Far associare ogni sillaba con la rispettiva immagine e viceversa.

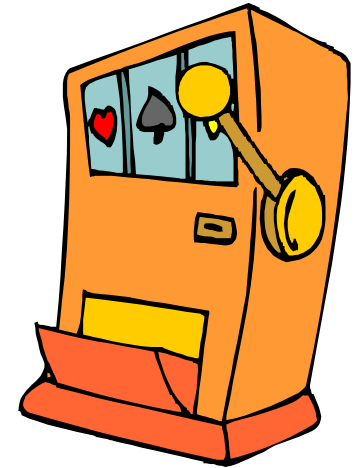
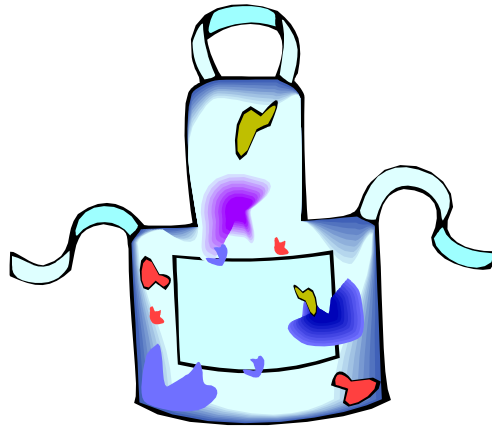
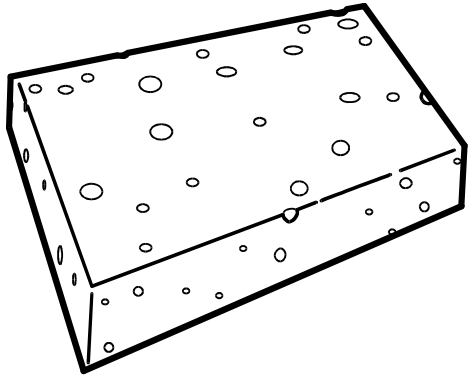

slot

spu

grem

LETTURA SILLABICO-FONEMATICA
Far associare ogni sillaba con la rispettiva immagine e viceversa.

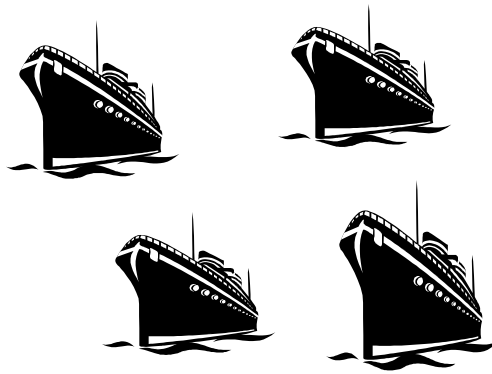
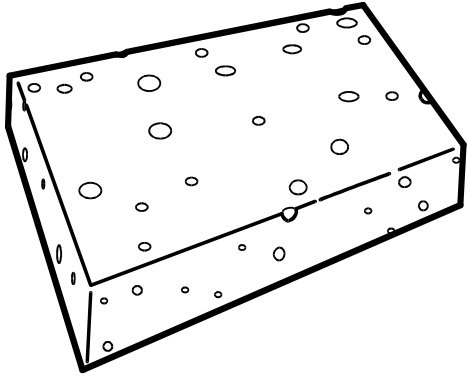

FLOTTA

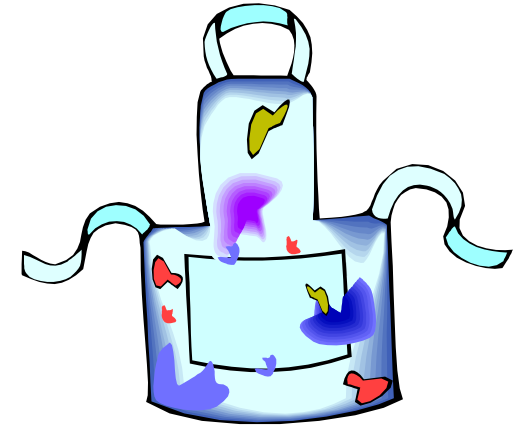

SPU

GREM

FLO

LETTURA SILLABICO-FONEMATICA
Far associare ogni sillaba con la rispettiva immagine e viceversa.

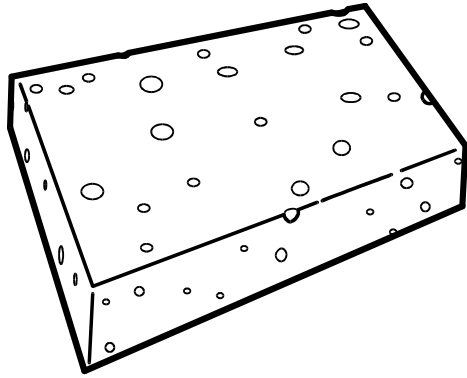
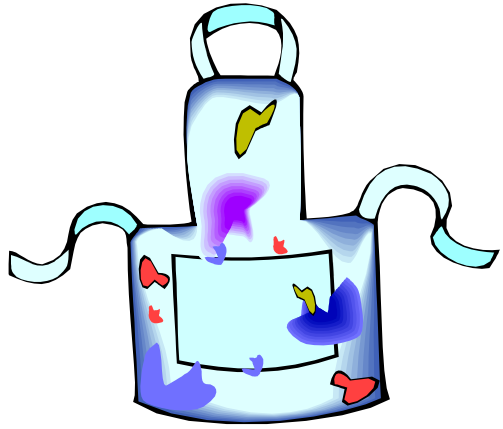

spu

grem

flo

LETTURA SILLABICO-FONEMATICA
Far associare ogni sillaba con la rispettiva immagine e viceversa.

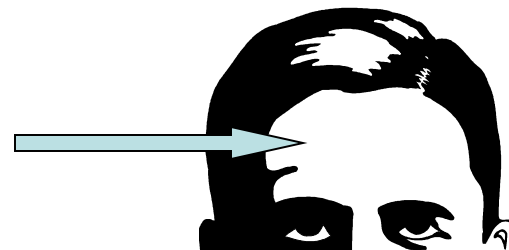
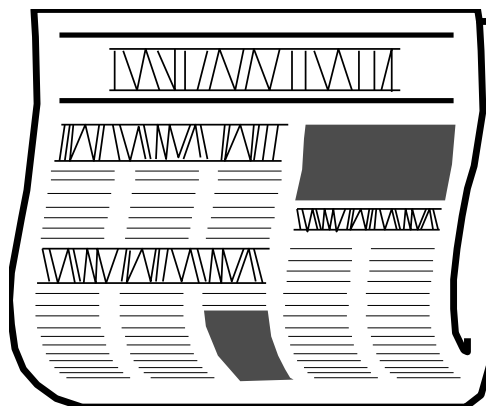
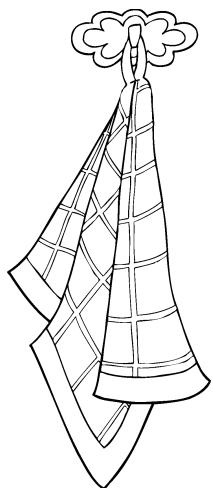

- FRONTE
 - STROFINACCIO
 - QUOTIDIANO

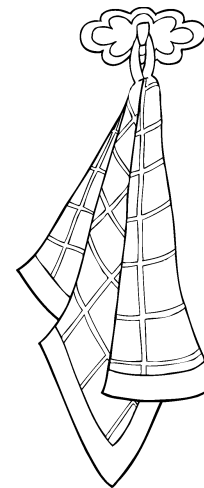
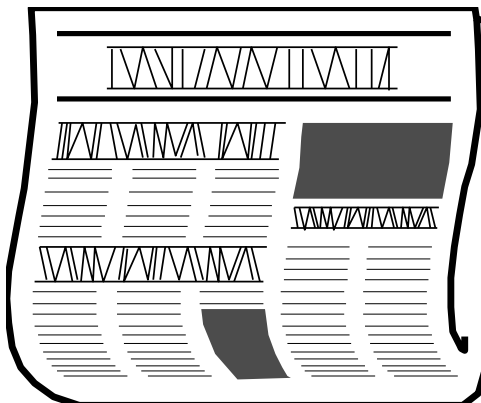
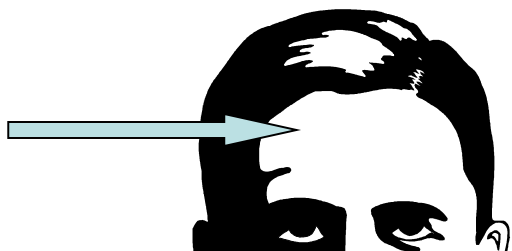

- fronte
- strofinaccio
- quotidiano

15

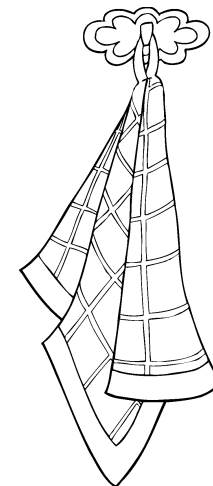
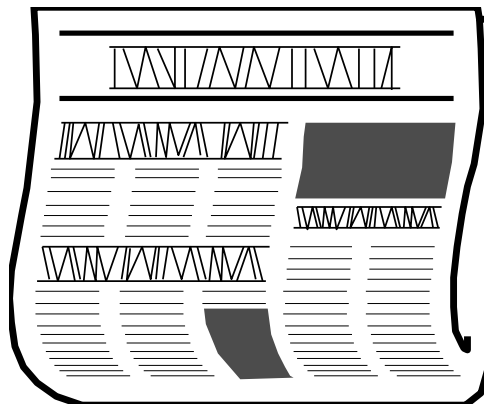

- STROFINACCIO
 - QUOTIDIANO
- QUINDICI

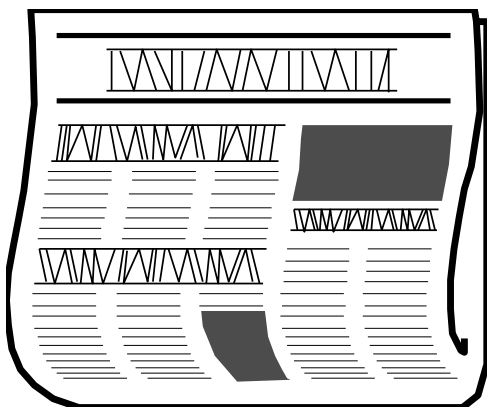

15

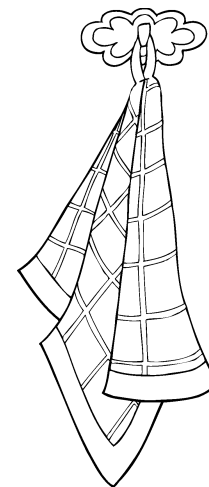

- strofinaccio
- quotidiano
- quindici

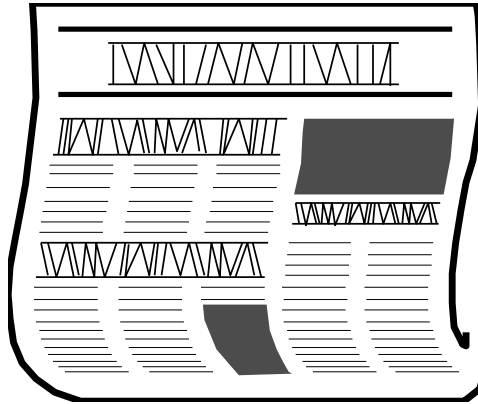

15

- STROFINACCIO
 - QUOTIDIANO
- FRECCIA



15

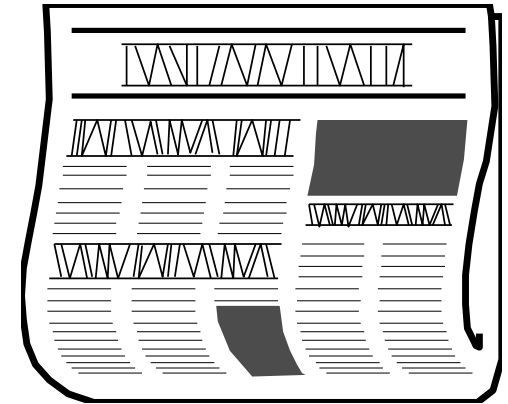

- strofinaccio
- quotidiano
- freccia

15



- QUINDICI
 - FRECCIA
- QUERCIA



15



- quindici

- freccia

- quercia



- FRECCIA
 - QUERCIA
- STATUA



• freccia

• quercia

• statua



- QUERCIA

- STATUA

- TROTTOLA



- quercia

- statua

- trottola

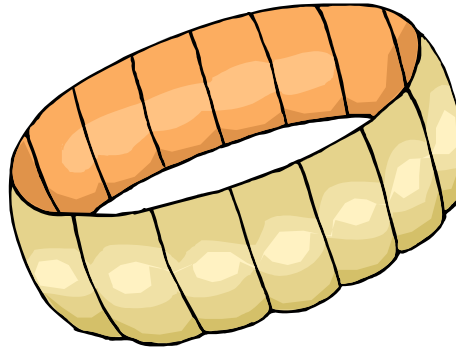

- STATUA
 - TROTTOLA
 - BRACCIALE

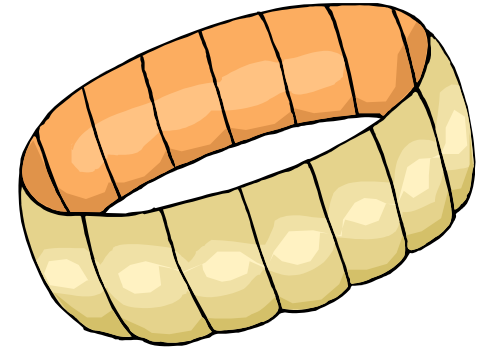

- statua

- trottola

- bracciale

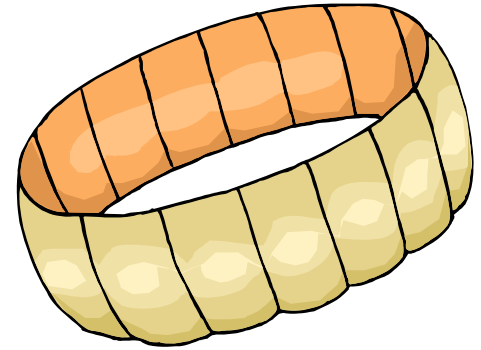
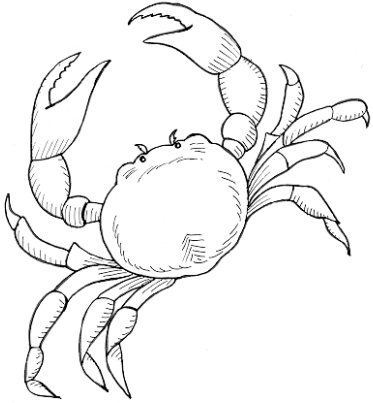

- TROTTOLA
- BRACCIALE
- GRANCHIO

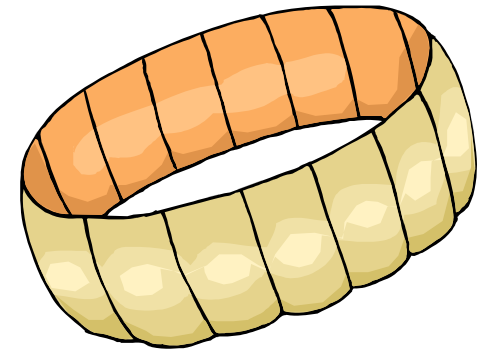
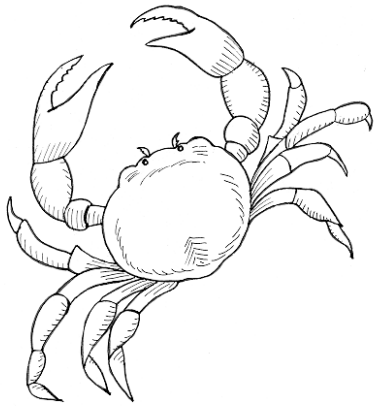

• trottola

• bracciale

• granchio

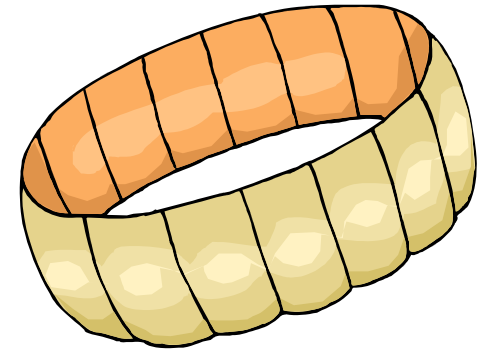
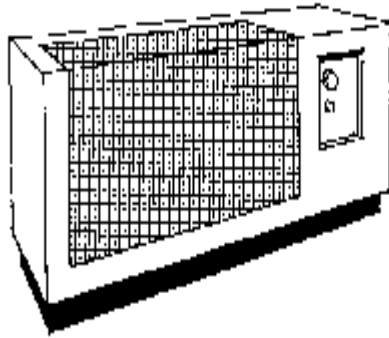
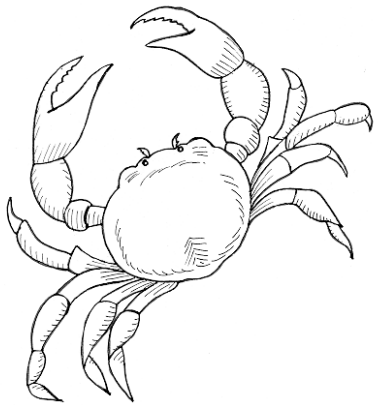

- BRACCIALE
- GRANCHIO
- STUFA

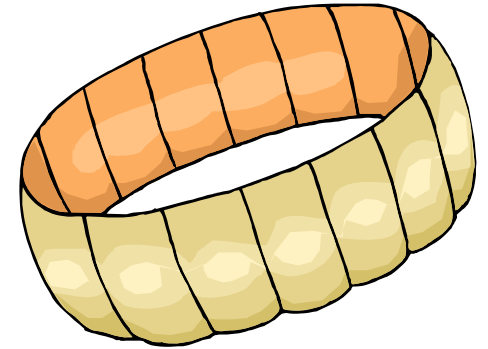
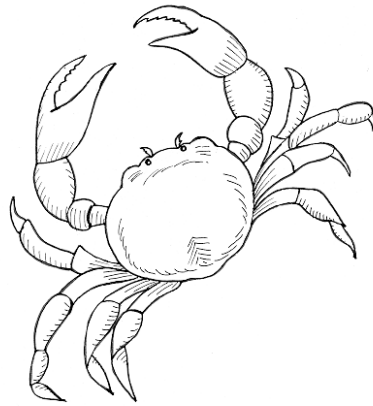
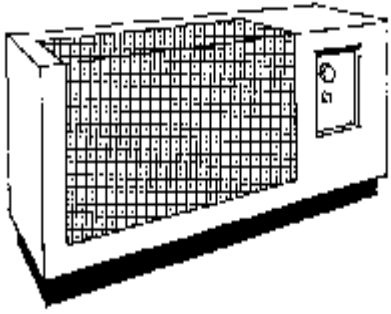

- bracciale

- granchio

- stufa

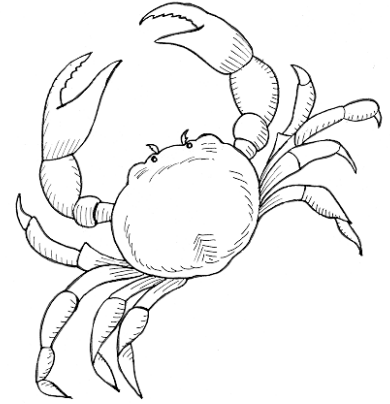
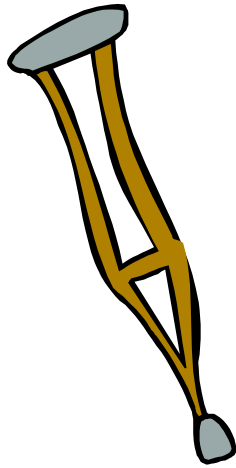
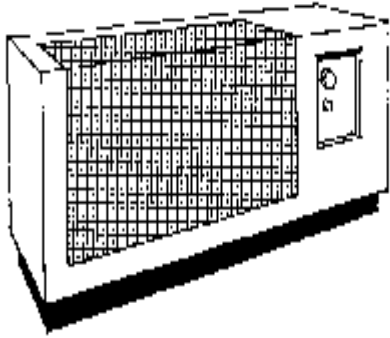

- GRANCHIO
 - STUFA
 - GRUCCIA

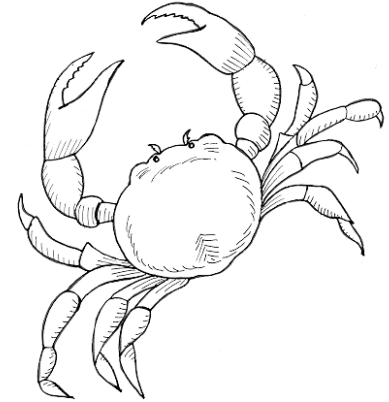
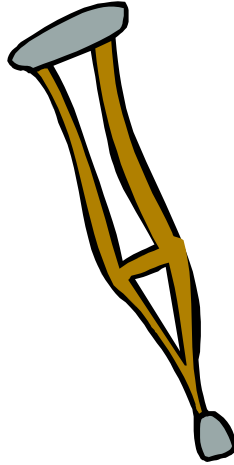
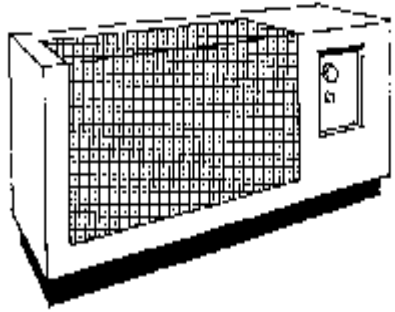

- granchio

- stufa

- gruccia

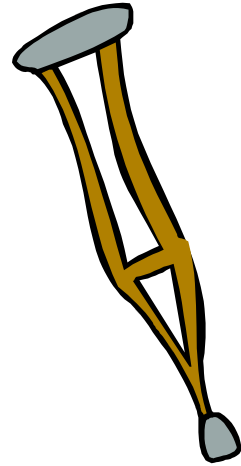
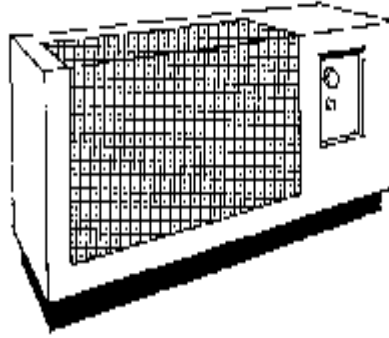

- STUFA
- GRUCCIA
- PRINCIPESSA

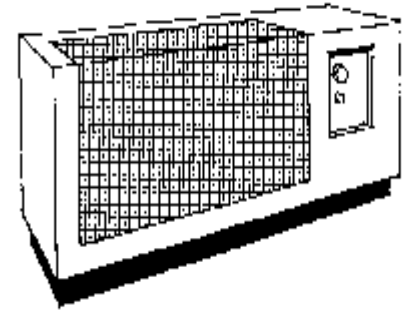
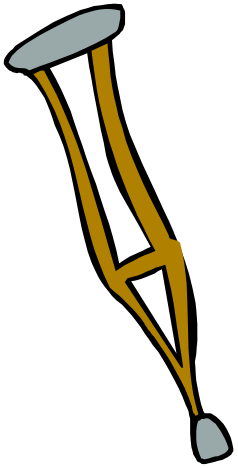

- stufa

- gruccion

- principessa

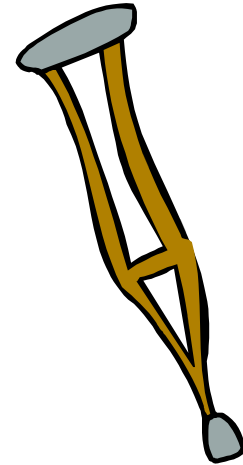
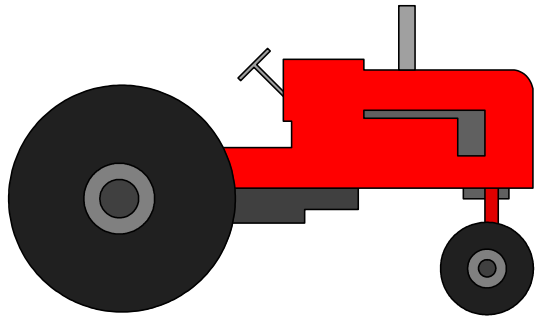

- GRUCCIA
 - PRINCIPESSA
 - TRATTORE

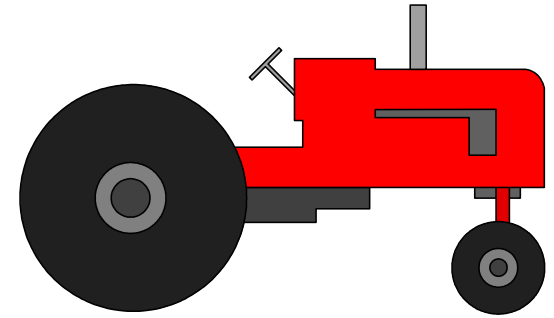
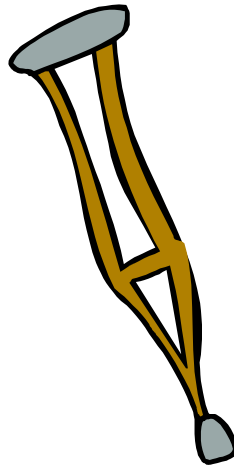

- gruccion

- principessa

- trattore

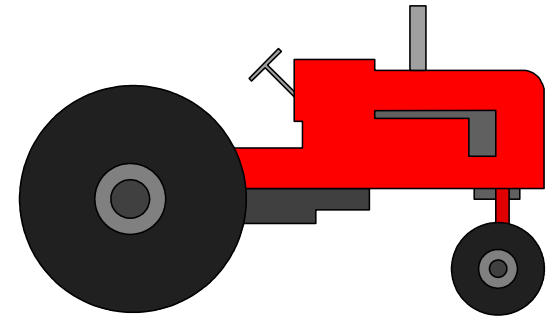
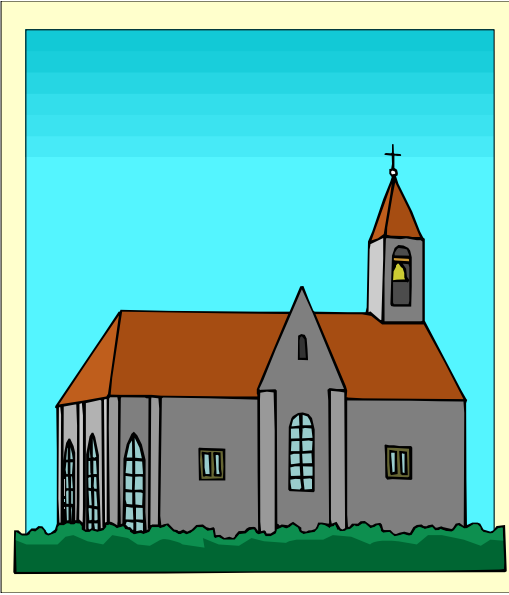

- PRINCIPESSA
- TRATTORE
- CHIESA

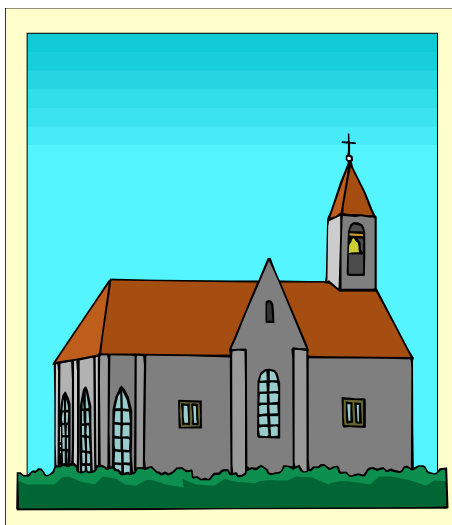
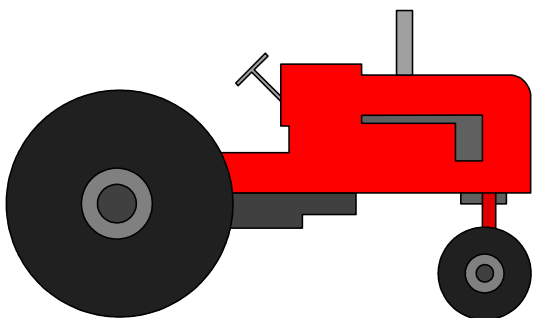

- principessa
- trattore
- chiesa

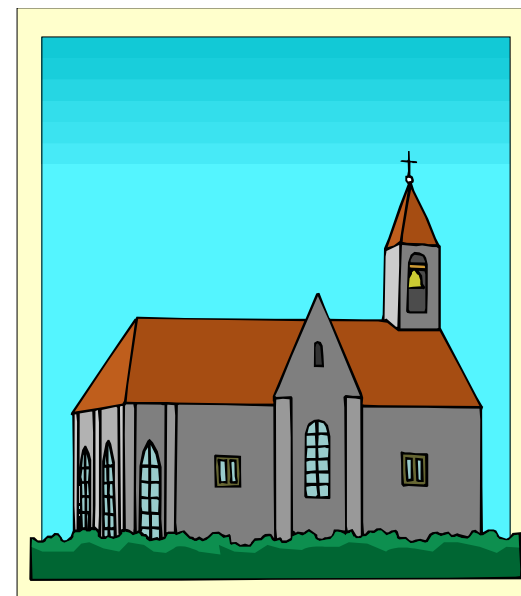
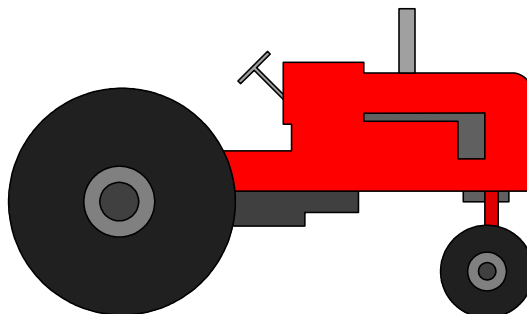
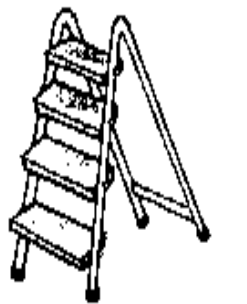

- TRATTORE
 - CHIESA
 - SCALA

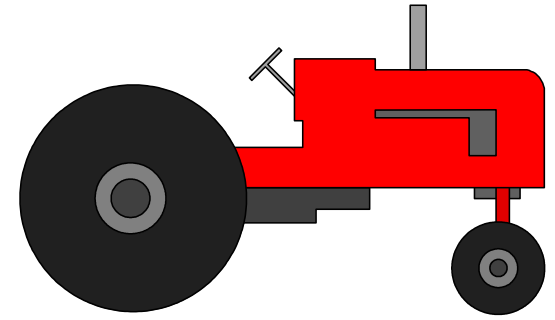
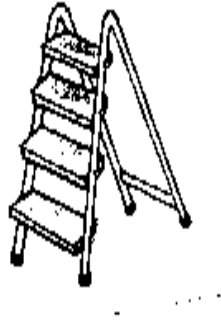
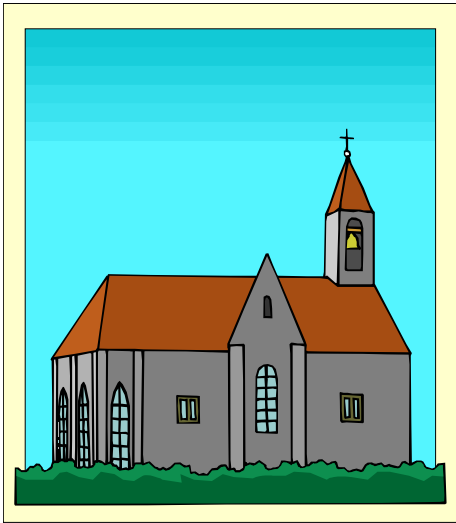

• trattore

• chiesa

• scala

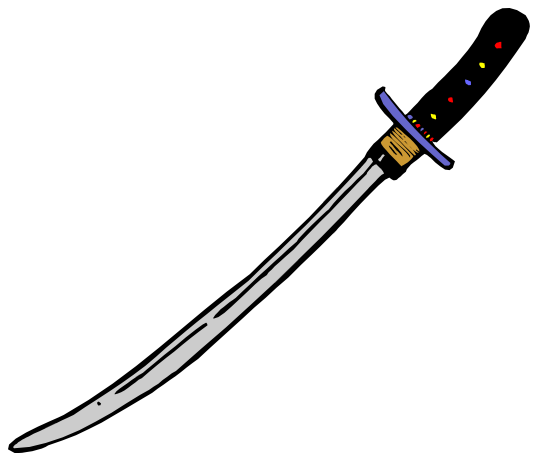

- SCALA
 - SPOSA
 - SPADA

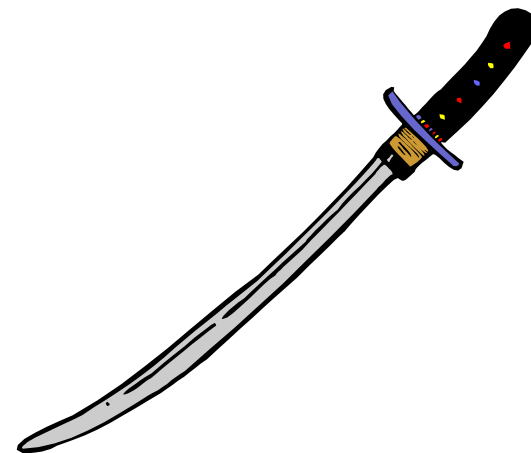

• scala

• sposa

• spada

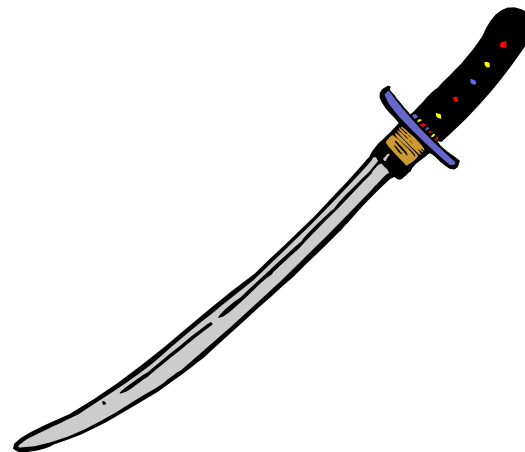

• SPOSA

• SPADA

• GNOMO

LETTURA SILLABICO-FONEMATICA

Far leggere e associare ogni parola all'immagine corrispondente.

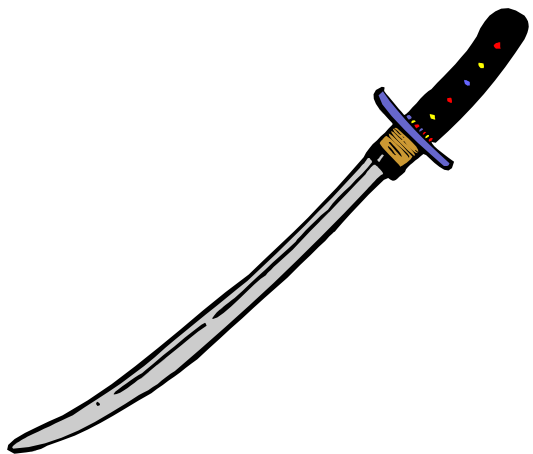

• sposa

• spada

• gnomo

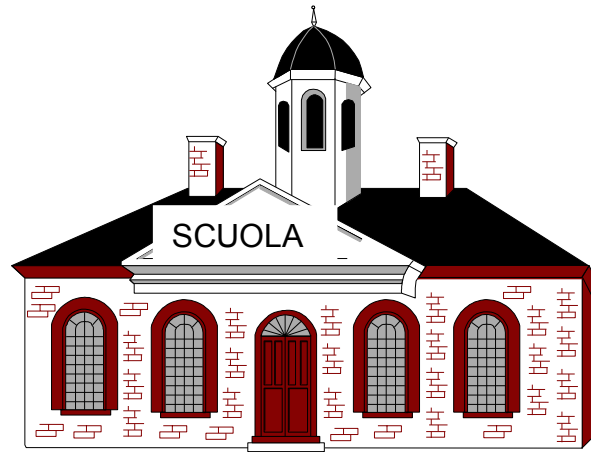
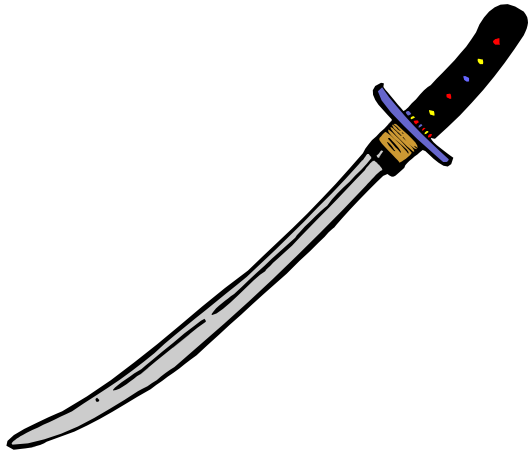

• SPADA

• GNOMO

• SCUOLA

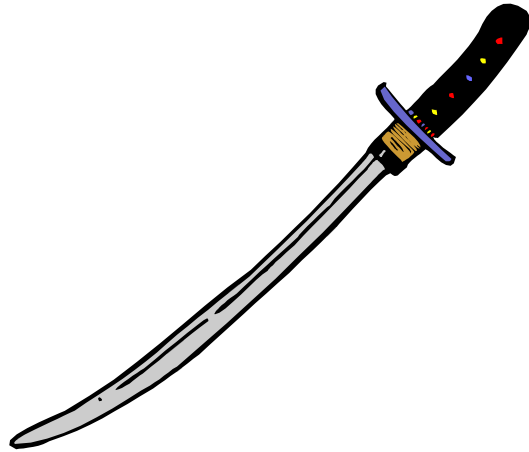

- spada

- gnomo

- scuola

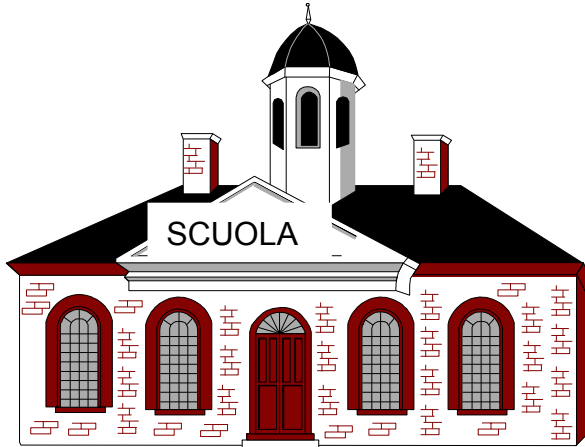
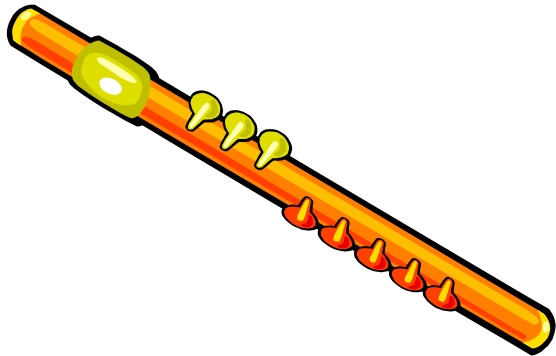

- GNOMO

- SCUOLA

- FLAUTO

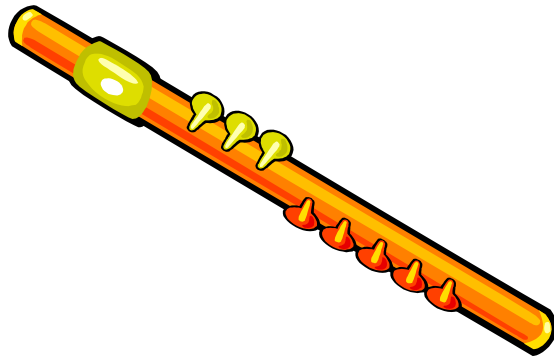

- gnomo

- scuola

- flauto

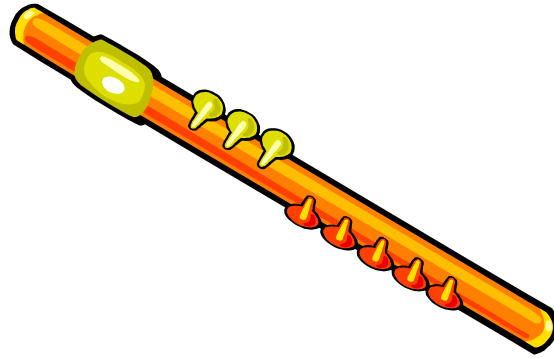
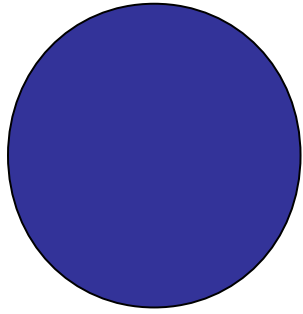

- SCUOLA

- FLAUTO

- BLU

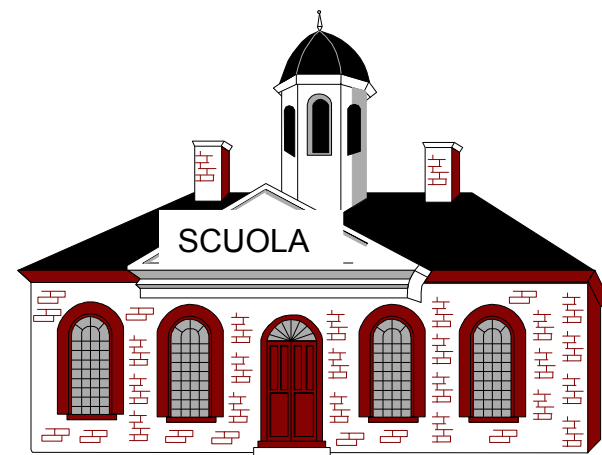
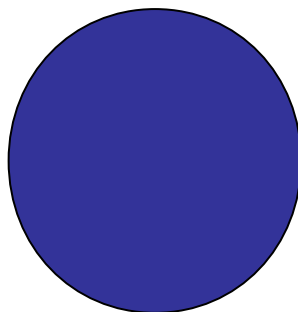
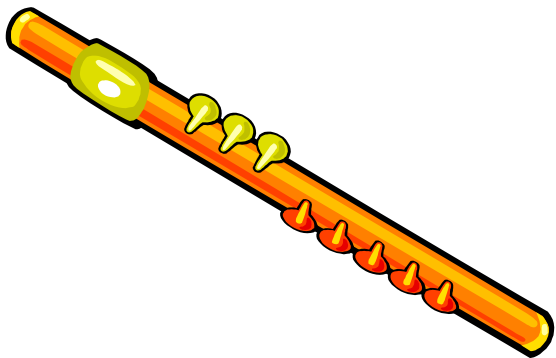

- scuola

- flauto

- blu

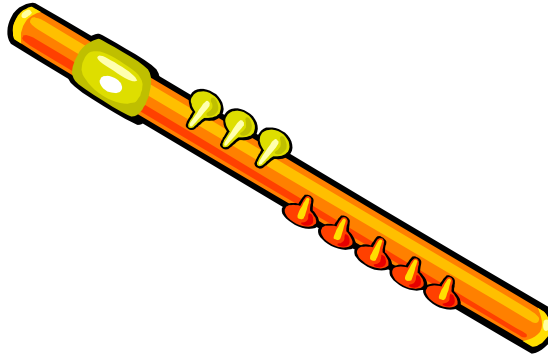
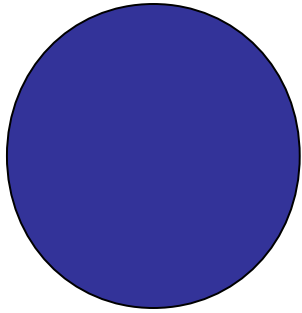

• FLAUTO

• BLU

• SCERIFFO

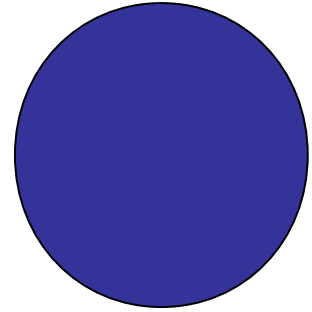
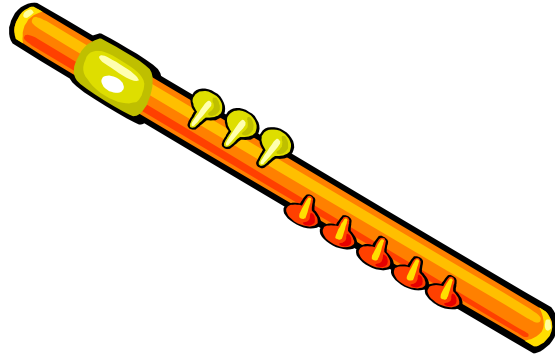

• flauto

• blu

• sceriffo

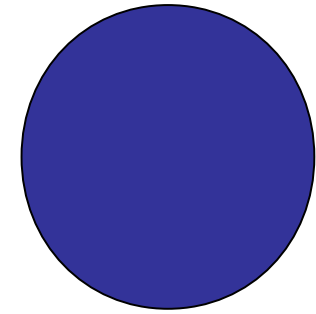

• BLU

• SCERIFFO

• SCOPA

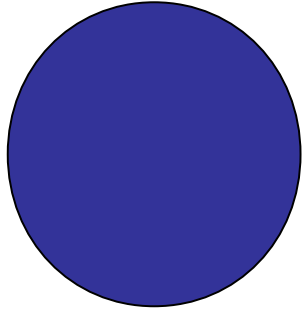

- blu

- sceriffo

- scopa

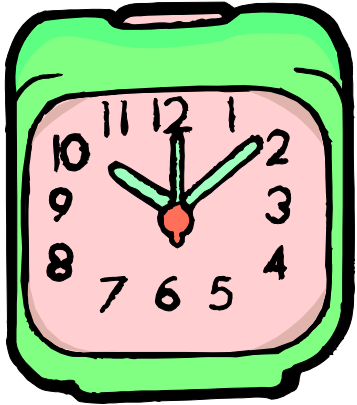

• SCERIFFO

• SCOPA

• SVEGLIA

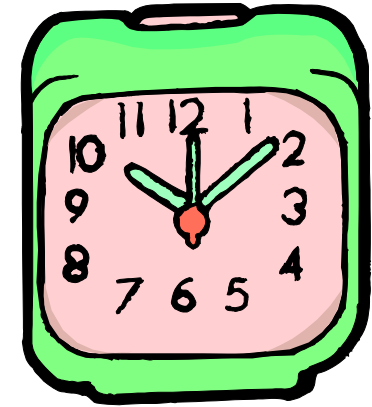

- sceriffo

- scopa

- sveglia

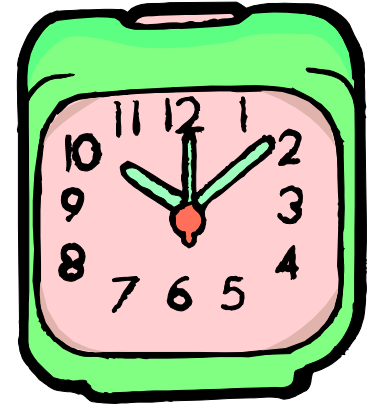
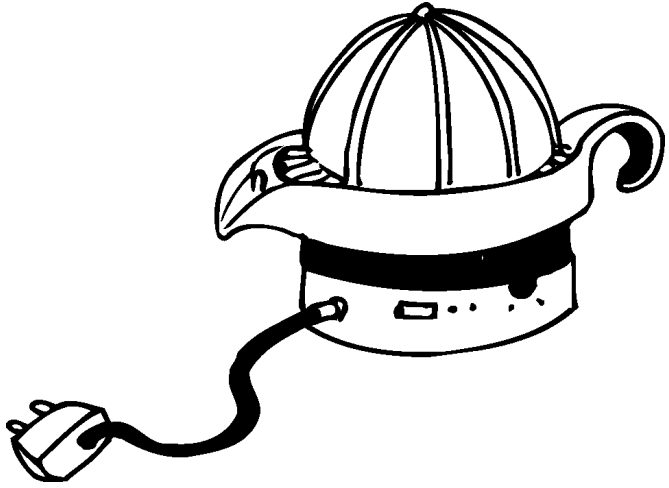

- SCOPA
- SVEGLIA
- SPREMIAGRUMI

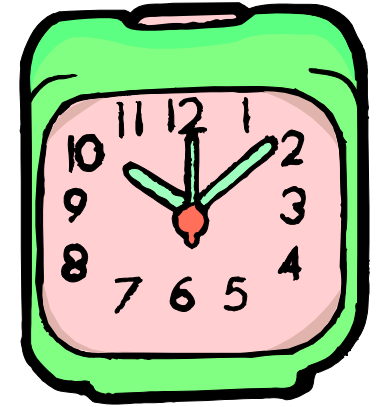
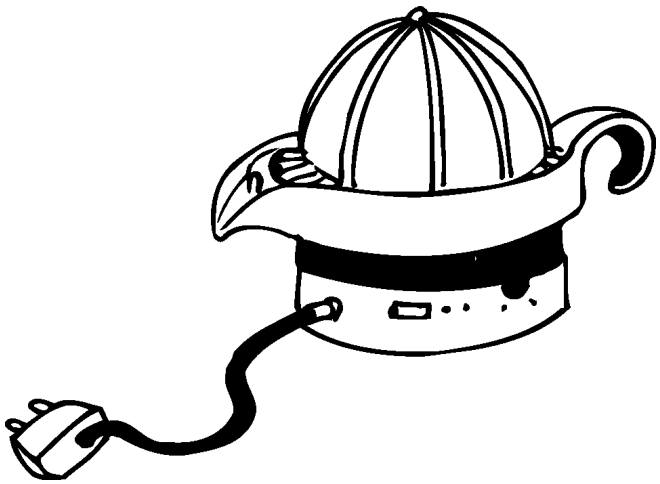

- scopa
- sveglia
- spremiagrumi

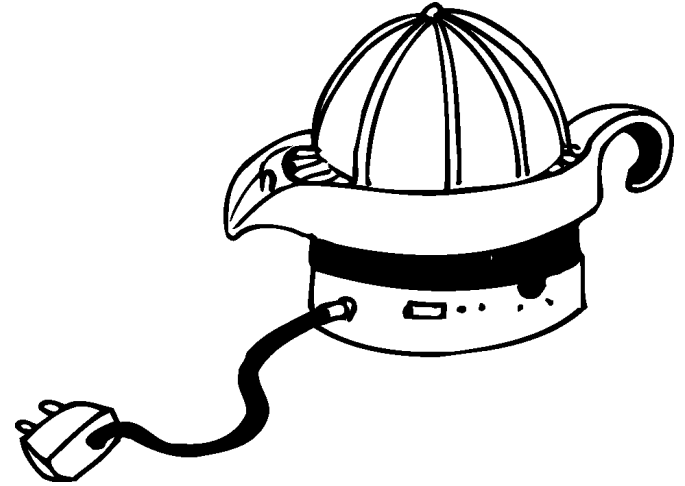
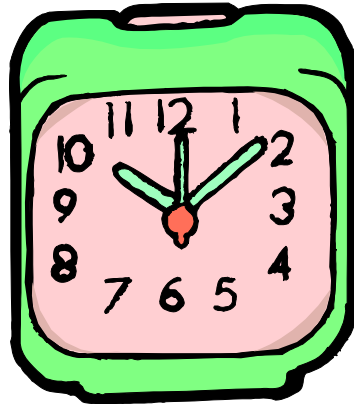

- SVEGLIA

- SPREMIAGRUMI

- SLITTA

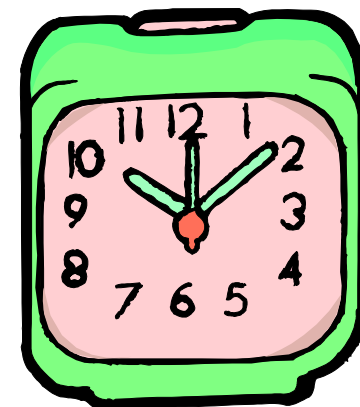
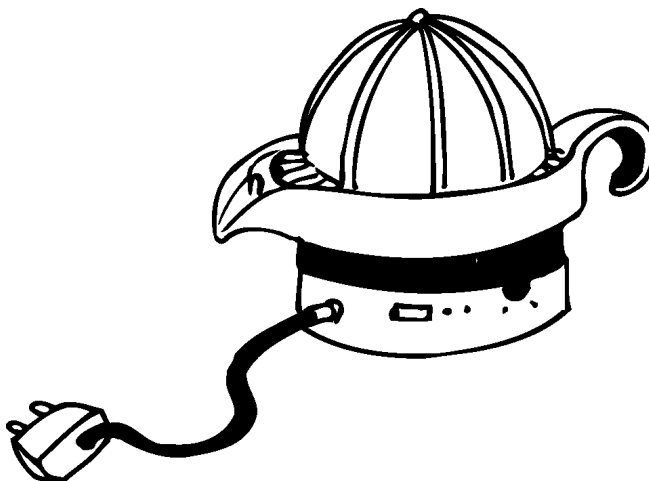
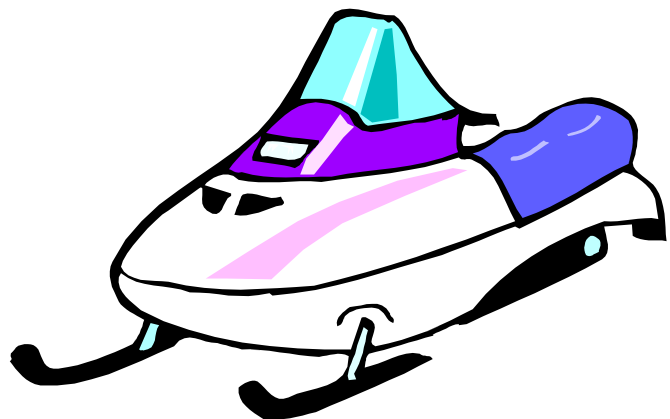

- sveglia

- spremiagrumi

- slitta

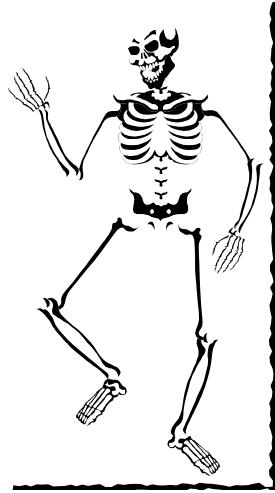
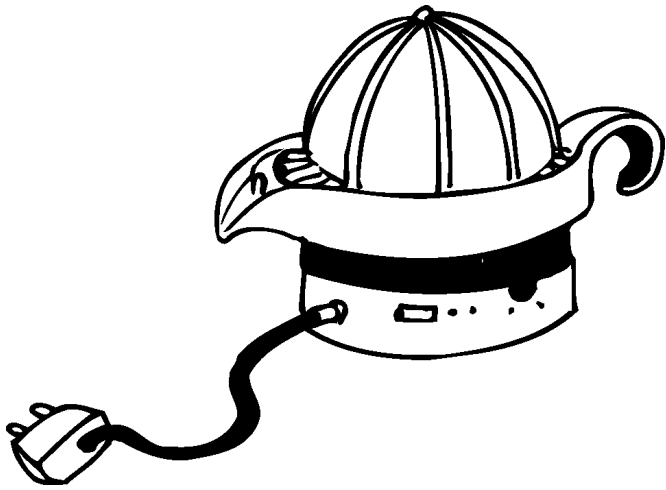

- SPREMIAGRUMI

- SLITTA

- SCHELETRO

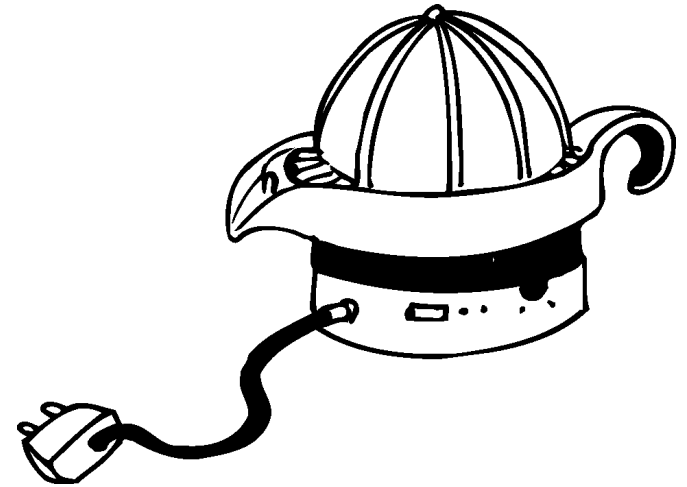
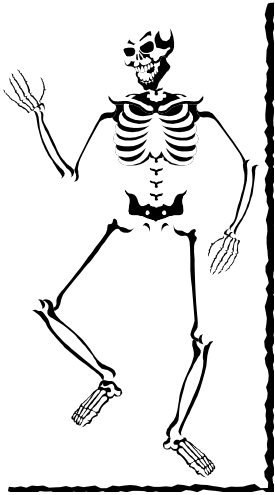

- spremiagrumi

- slitta

- scheletro

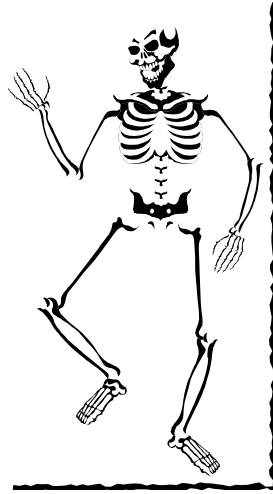
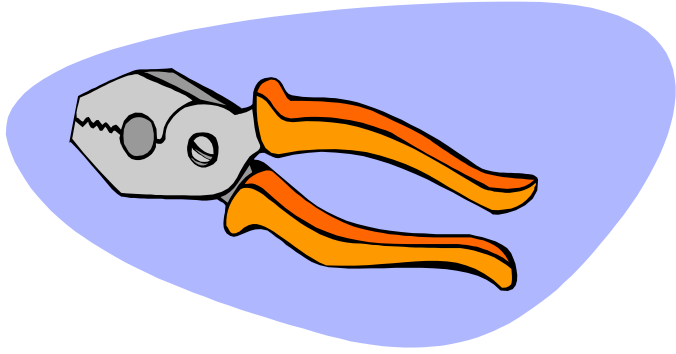

• SLITTA

• SCHELETRO

• PINZA

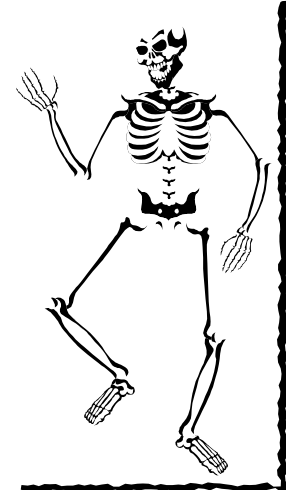
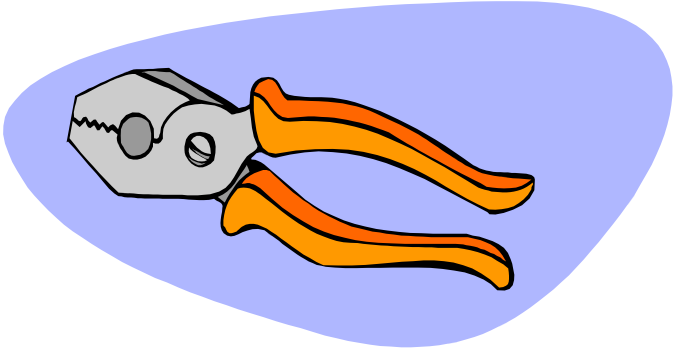

- slitta

- scheletro

- pinza

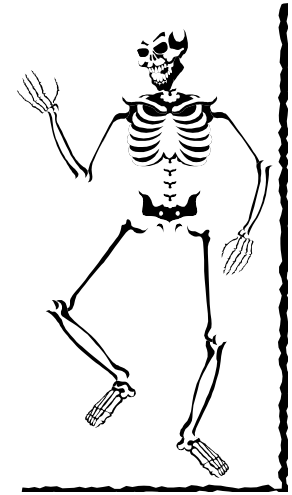
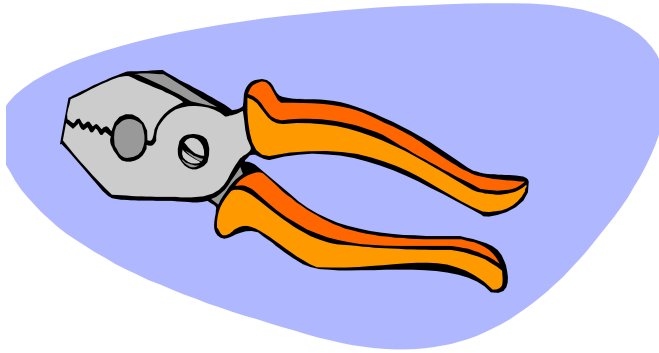
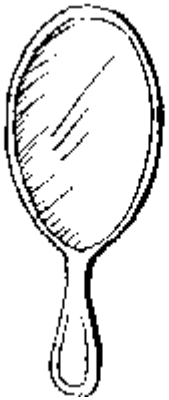

- SCHELETRO

- PINZA

- SPECCHIO

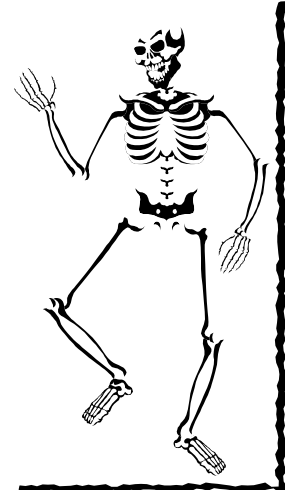
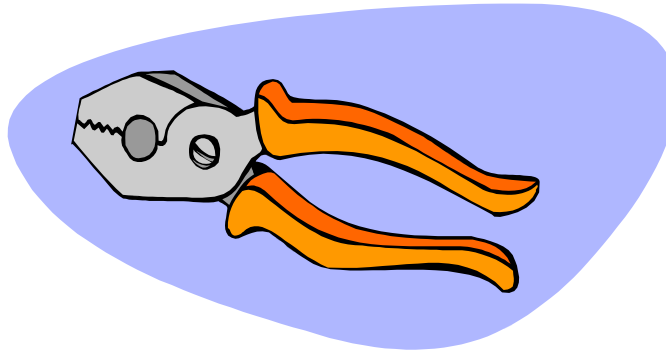
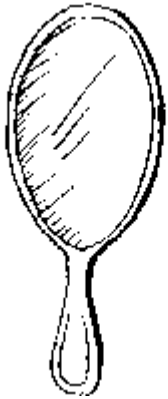

- specchio
- pinza
- scheletro

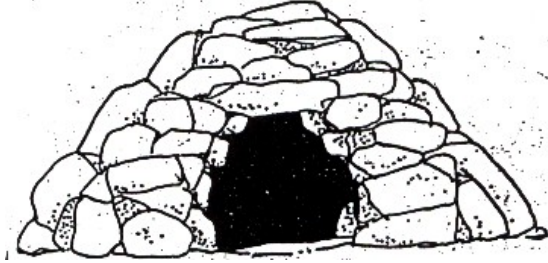
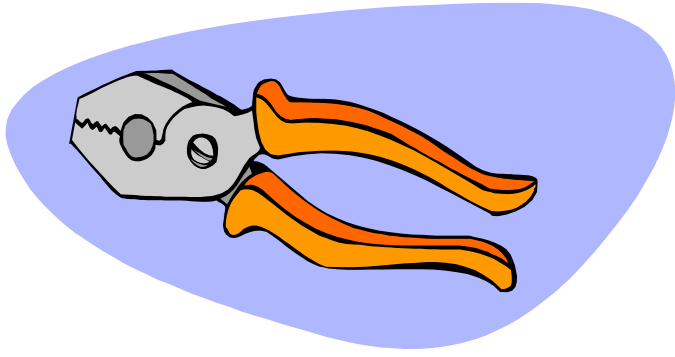

• PINZA

• SPECCHIO

• GROTTA

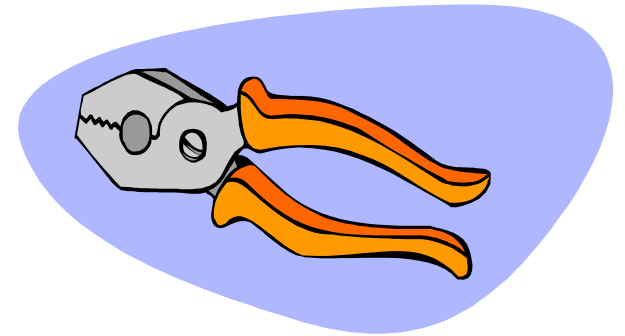
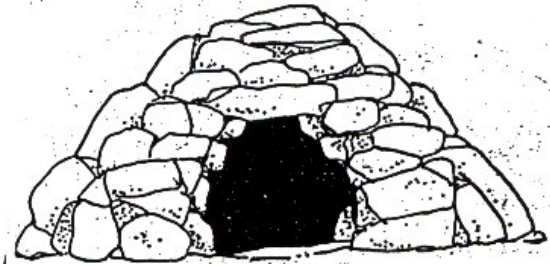

• pinza

• specchio

• grotta

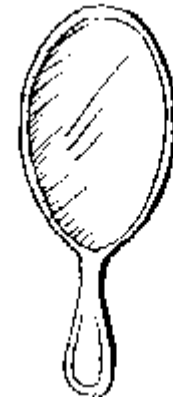
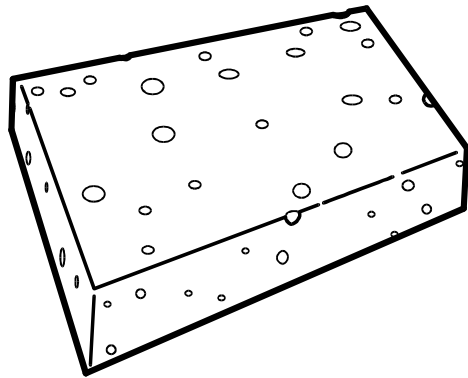
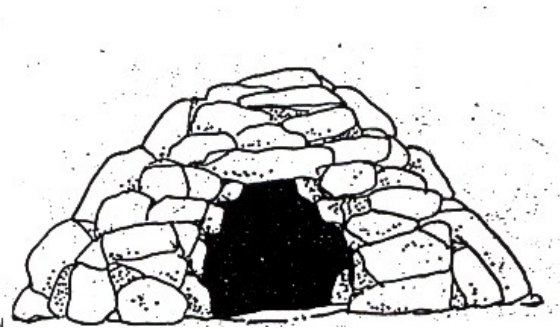

• SPECCHIO

• GROTTA

• SPUGNA

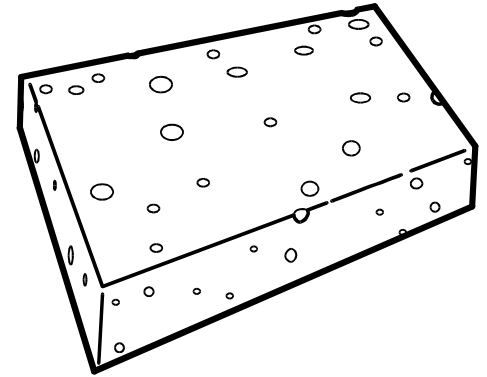
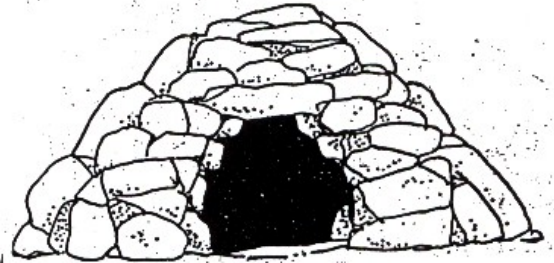

- specchio

- grotta

- spugna