

VOGLIA DI ESSERE

PROGRAMMA BASE PER LA TERZA ETA'

Emidio Tribulato



Il mio vocabolario: la casa
Il mio vocabolario: la casa

CENTRO STUDI LOGOS
ONLUS
CENTRO DI RICERCHE PSICOPEDAGOGICHE
VIA PRINCIPE TOMMASO 2 - MESSINA
TEL. 090/46920
DIRETTORE: DOTT. EMIDIO TRIBULATO

“VOGLIA DI ESSERE”

PROGRAMMA BASE PER LA TERZA ETÀ

Emidio Tribulato

INDICE

“Il mio vocabolario”: LA CASA

“ 3



2005 - Tutti i diritti riservati. Emidio Tribulato Viale Annunziata 72
Messina – Tel. 090357149 - 09046920

E - mail: logos.messina@tiscali.it --- Sito Web. WWW.cslogos.it

IL MIO VOCABOLARIO: LA CASA

Queste schede hanno lo scopo di stimolare il ricordo dei nomi di alcuni oggetti che possiamo ritrovare quotidianamente nelle nostre case. Ciò dovrebbe contribuire ad ottenere una maggiore ricchezza del vocabolario presente nell'anziano.

Queste schede sono triple. Nella prima, sotto l'immagine, è presente il nome dell'oggetto. Questa scheda è stata chiamata *scheda con aiuto verbale*. Nella seconda vengono riproposte le stesse immagine ma bisogna collegare il nome all'oggetto rappresentato (*scheda associazione nome – oggetto rappresentato*), nella terza scheda bisogna dire il nome dell'oggetto senza avere alcun aiuto (*scheda senza aiuto verbale*). Tuttavia, nel caso in cui l'anziano non ricordasse il nome, ha la possibilità di ritrovarlo nelle schede precedenti.

Giacché le capacità di lettura vengono conservate anche in uno stadio abbastanza avanzato di demenza, l'anziano potrà utilizzare questo strumento per ricordare i nomi degli oggetti che può avere dimenticato.

“ VOGLIA DI ESSERE ”

PROGRAMMA BASE PER LA TERZA ETÀ

*“Il mio vocabolario”
- LA CASA -*

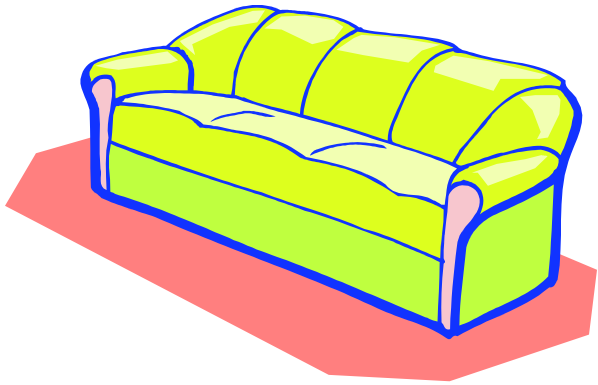

Il divano

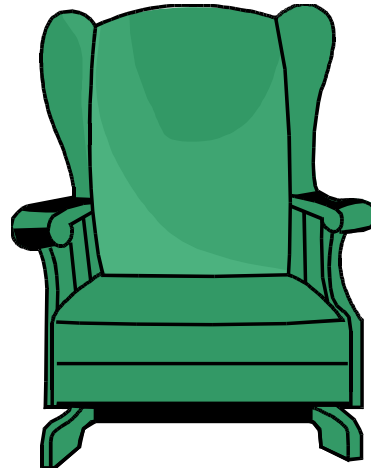

La poltrona

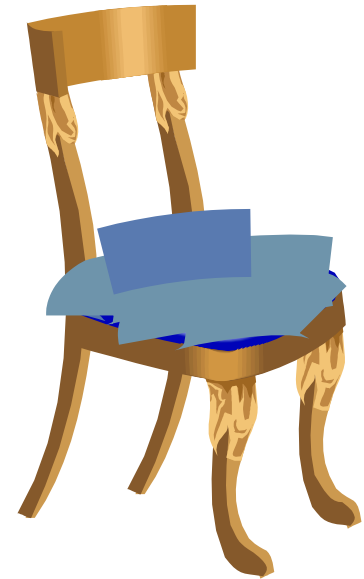

La sedia

“Il mio vocabolario”: LA CASA
Far associare ogni parola all’immagine corrispondente.

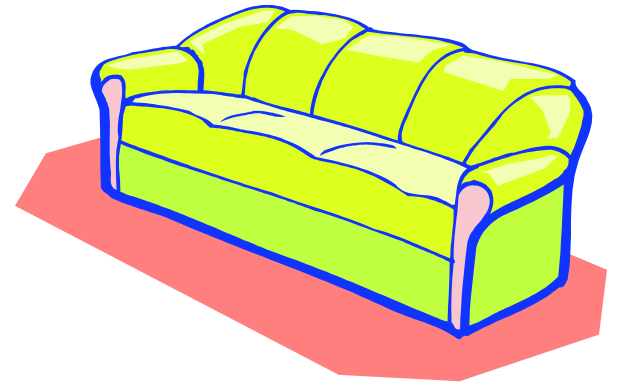
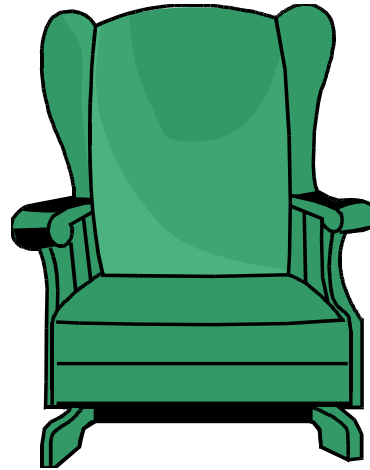
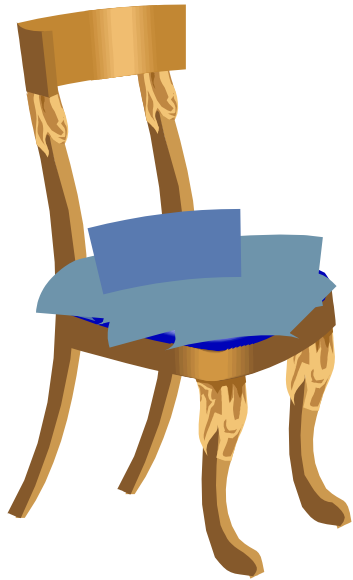

Il divano

La poltrona

La sedia

"Il mio vocabolario": LA CASA
Far associare ogni parola all'immagine corrispondente.

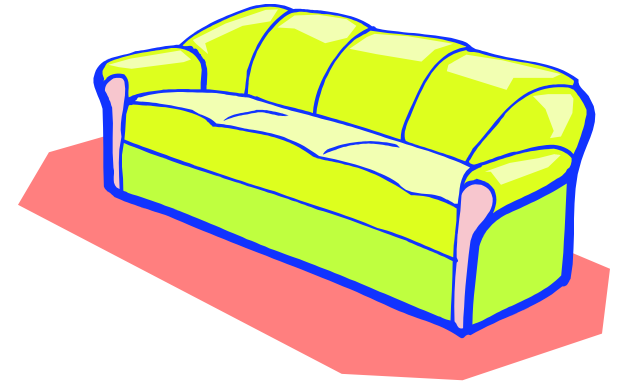
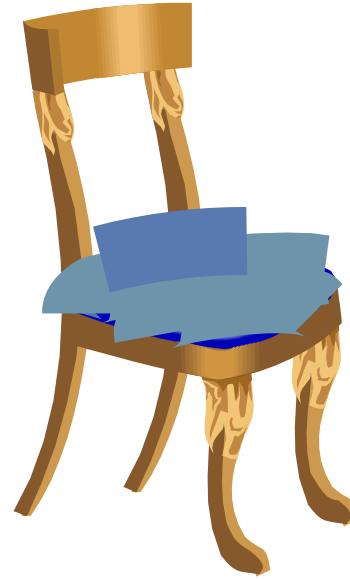
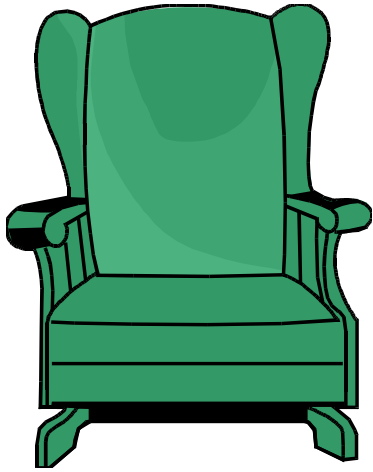

“Il mio vocabolario”: LA CASA
Come si chiama?

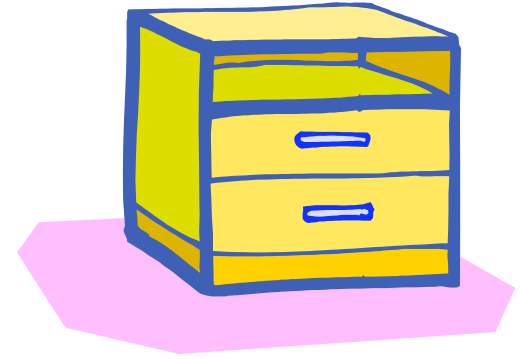
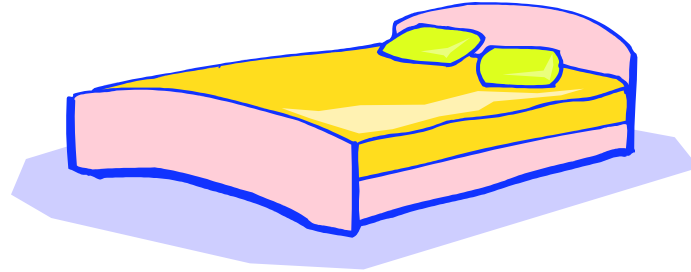

L'armadio

Il letto

Il comodino

“Il mio vocabolario”: LA CASA
Far associare ogni parola all'immagine corrispondente.

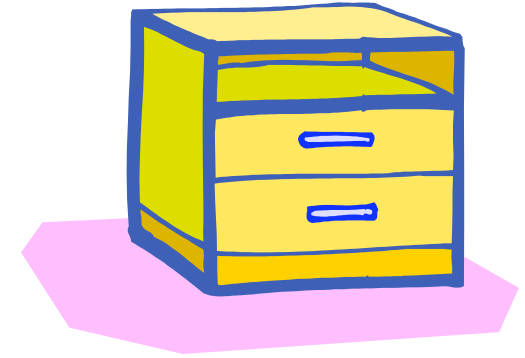
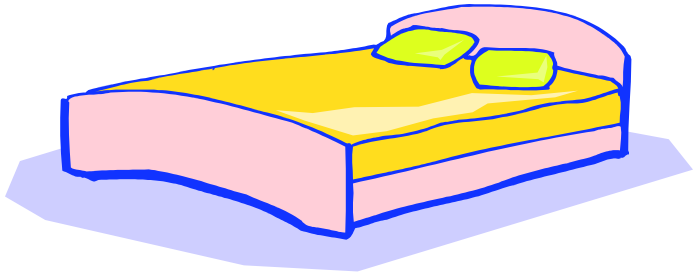

- L'armadio
- Il letto
- Il comodino

“Il mio vocabolario”: LA CASA
Far associare ogni parola all'immagine corrispondente.

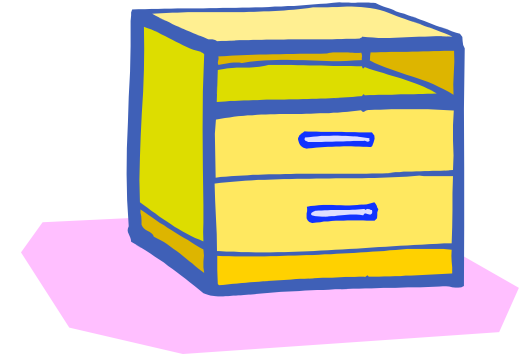
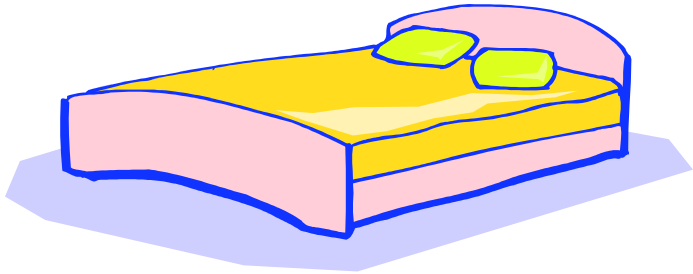

“Il mio vocabolario”: LA CASA
Come si chiama?



Le chiavi



Il tavolo

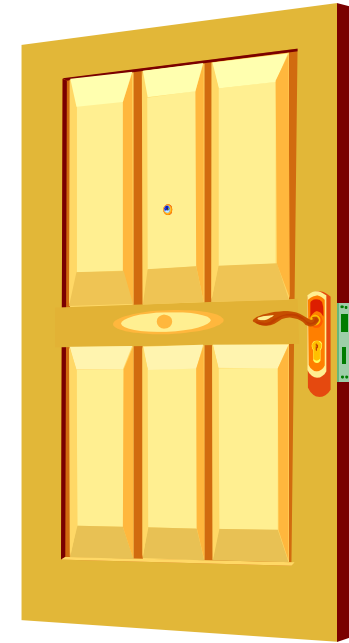

La porta

“Il mio vocabolario”: LA CASA
Far associare ogni parola all’immagine corrispondente.

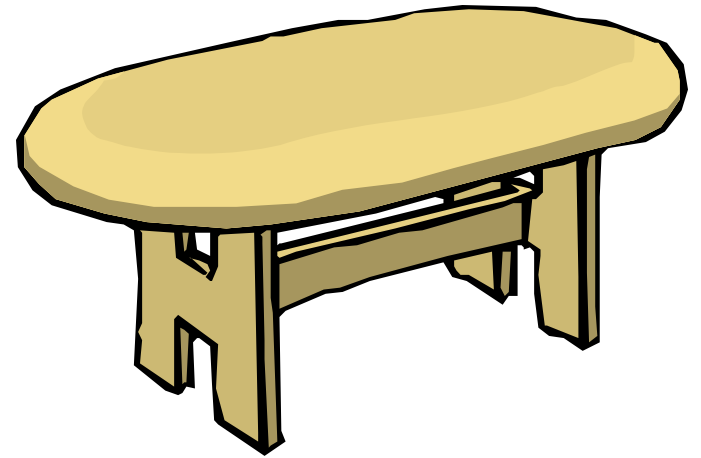

- Le chiavi
- Il tavolo
- La porta

"Il mio vocabolario": LA CASA
Far associare ogni parola all'immagine corrispondente.



"Il mio vocabolario": LA CASA
Come si chiama?

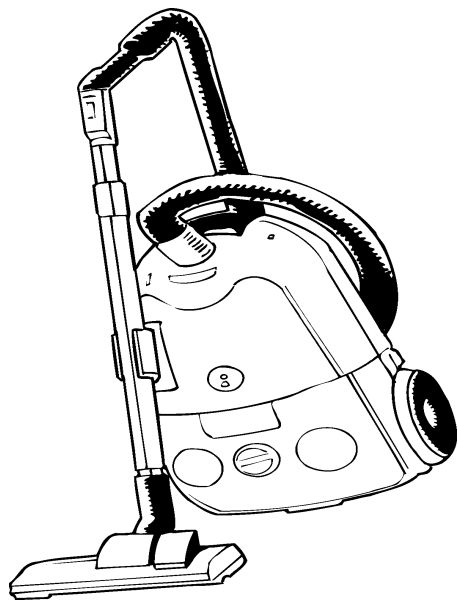

L'aspirapolvere

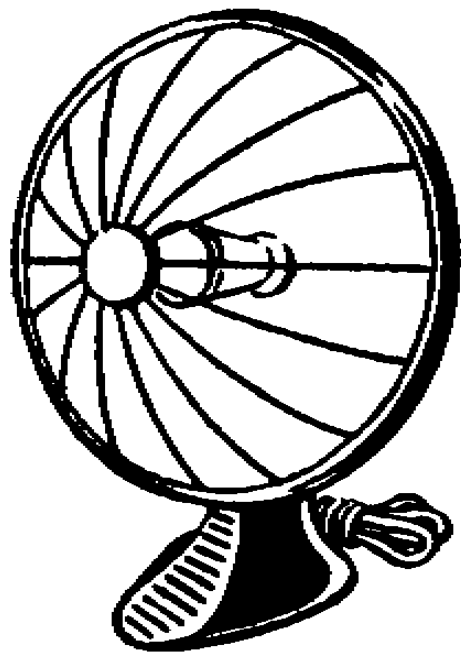

Il ventilatore

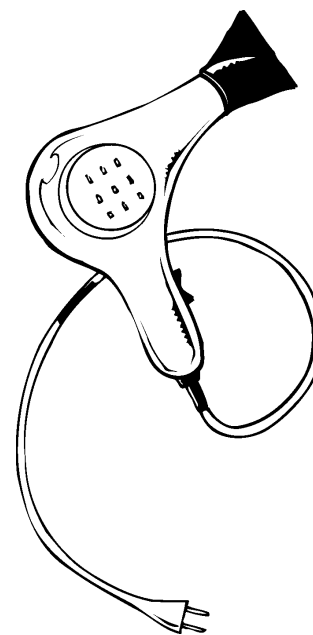

Il fon

"Il mio vocabolario": LA CASA
Far associare ogni parola all'immagine corrispondente.

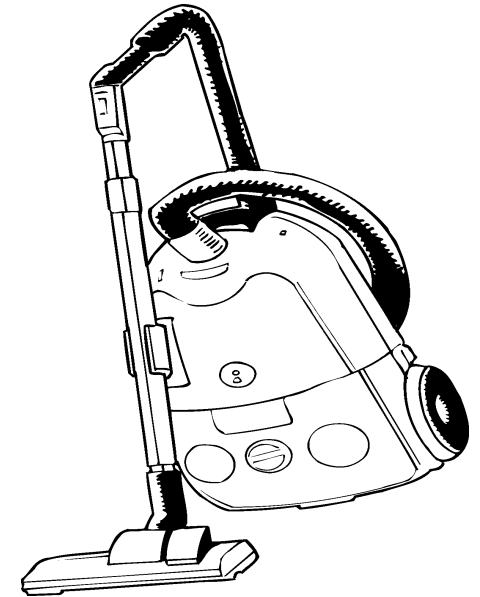
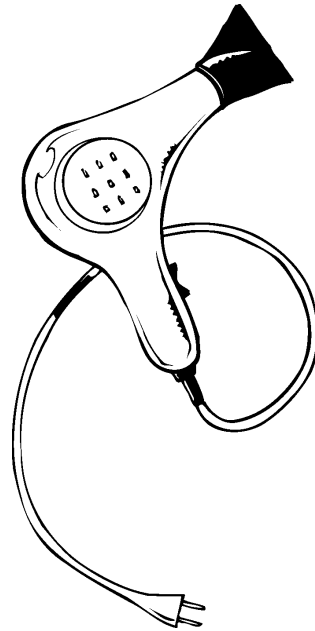
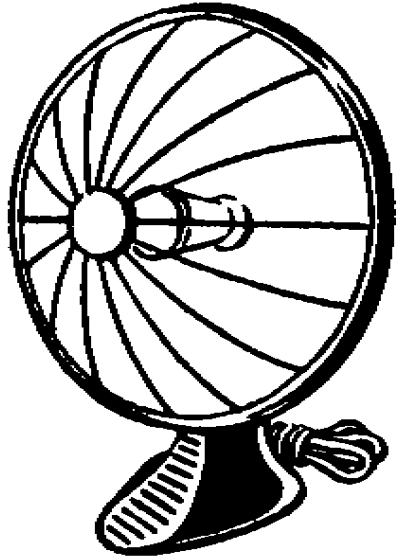

- L'aspirapolvere
- Il ventilatore
- Il fon

"Il mio vocabolario": LA CASA
Far associare ogni parola all'immagine corrispondente.

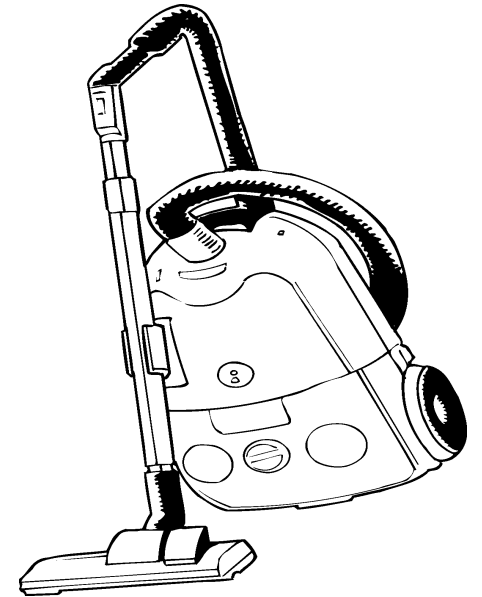
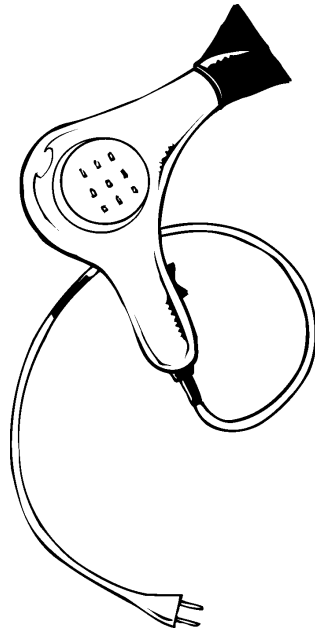
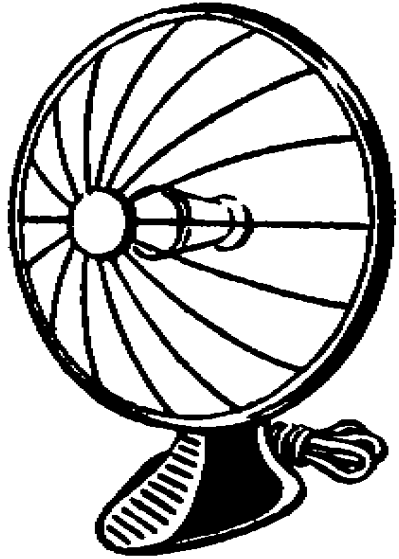

“Il mio vocabolario”: LA CASA
Come si chiama?

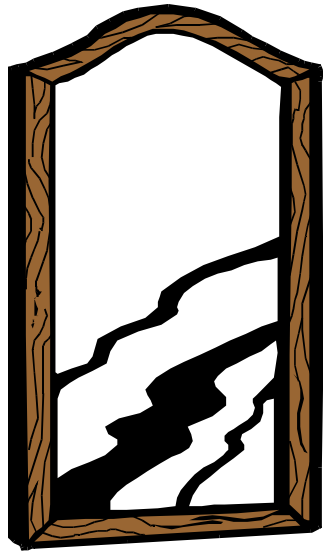

Lo specchio

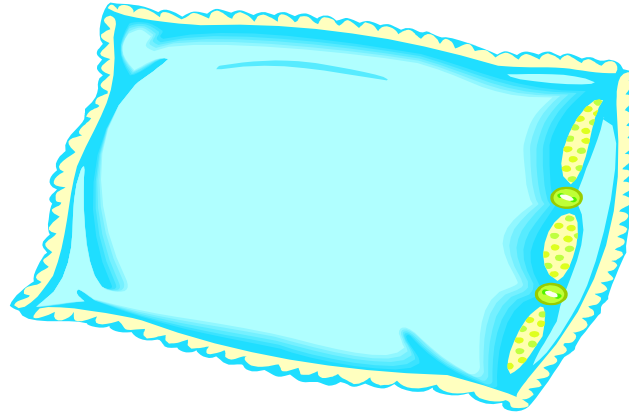

Il cuscino



Il quadro

“Il mio vocabolario”: LA CASA
Far associare ogni parola all’immagine corrispondente.

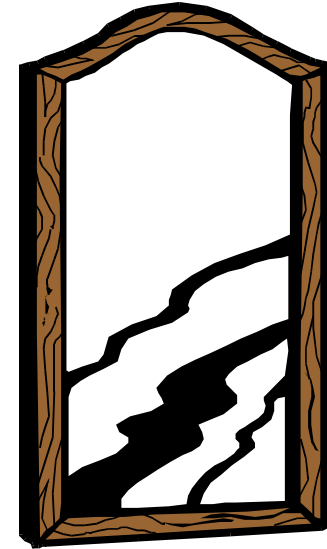
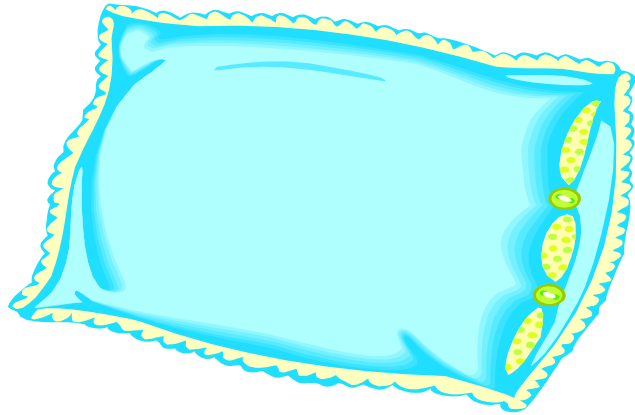

- Lo specchio
- Il cuscino
- Il quadro

“Il mio vocabolario”: LA CASA
Far associare ogni parola all’immagine corrispondente.

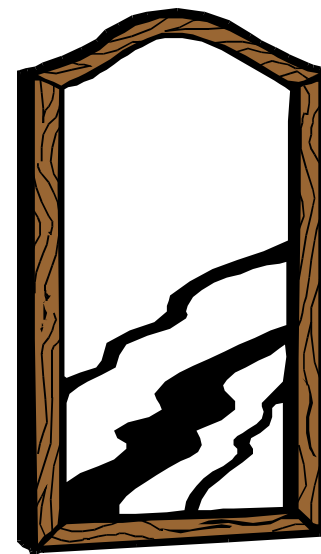
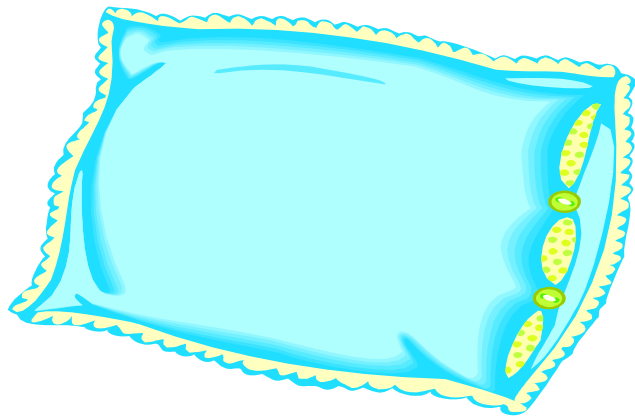

"Il mio vocabolario": LA CASA
Come si chiama?



L'asse da stiro

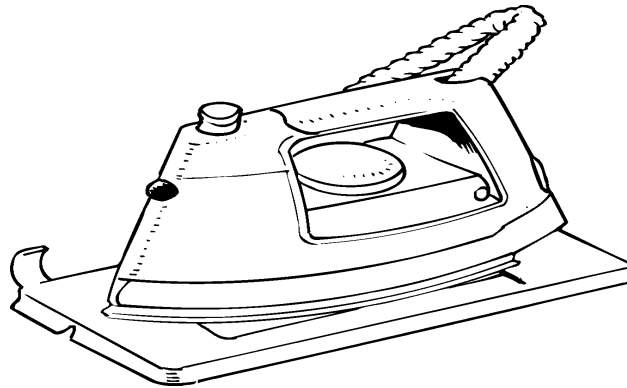

Il ferro da stiro

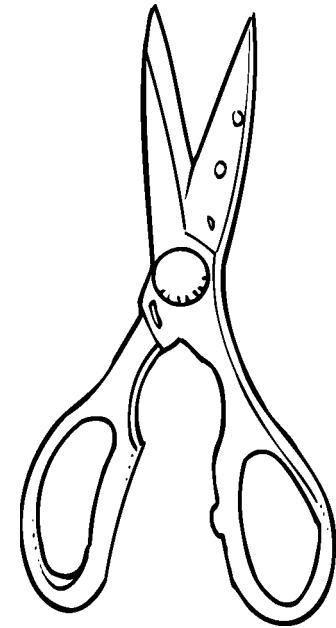

Le forbici

“Il mio vocabolario”: LA CASA
Far associare ogni parola all'immagine corrispondente.

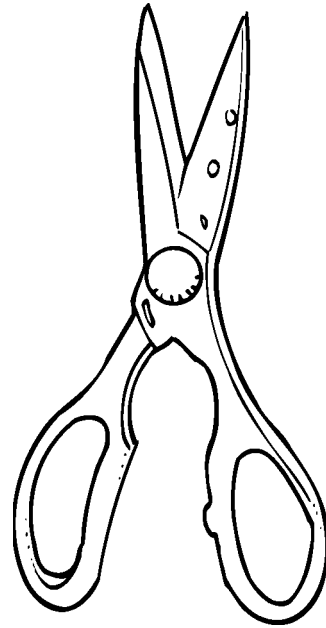
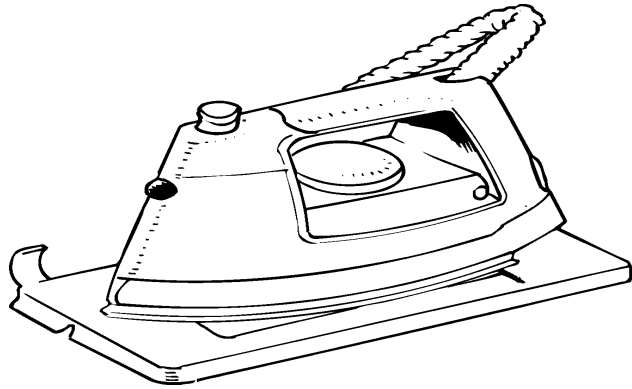

- Le forbici
 - L'asse da stiro
 - Il ferro da stiro

"Il mio vocabolario": LA CASA
Far associare ogni parola all'immagine corrispondente.

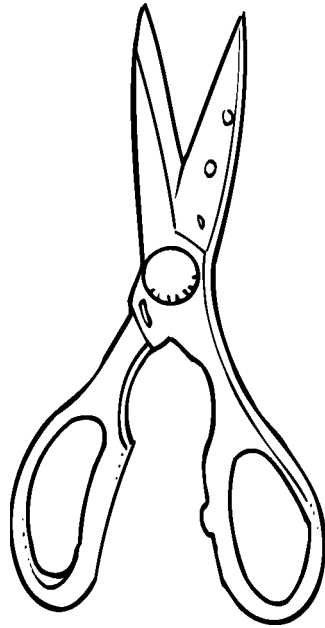
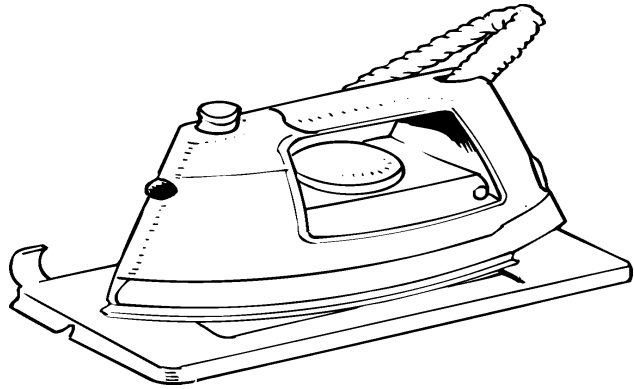

"Il mio vocabolario": LA CASA
Come si chiama?

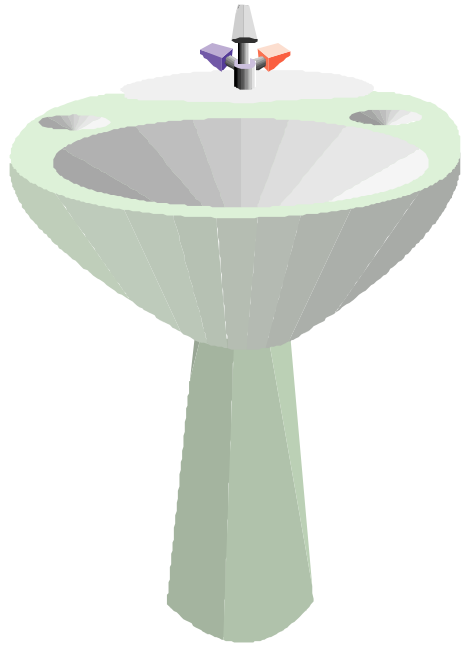

Il lavandino

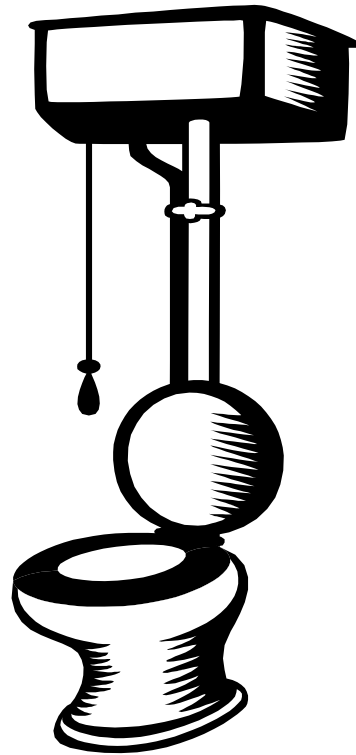

Il wc

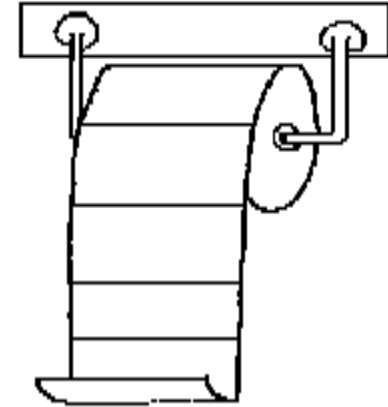

La carta igienica

“Il mio vocabolario”: LA CASA
Far associare ogni parola all’immagine corrispondente.

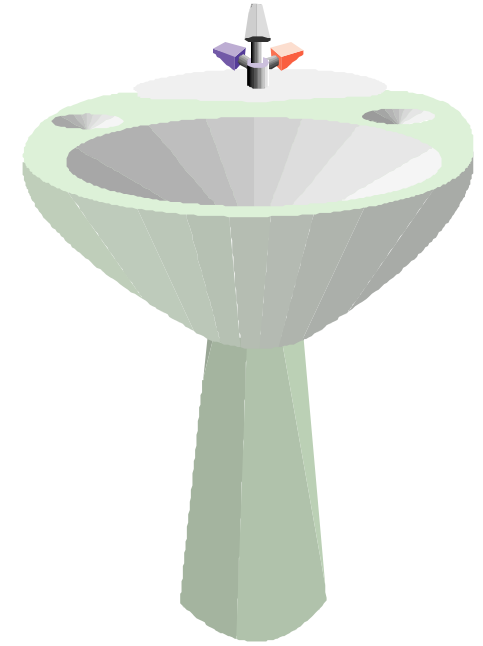
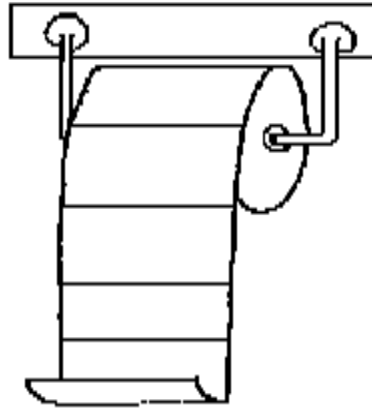
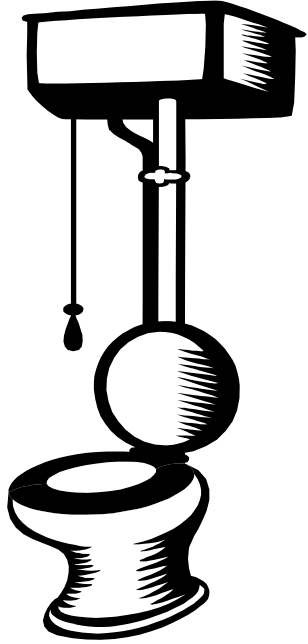

- La carta igienica
 - Il lavandino
 - Il wc

“Il mio vocabolario”: LA CASA
Far associare ogni parola all’immagine corrispondente.

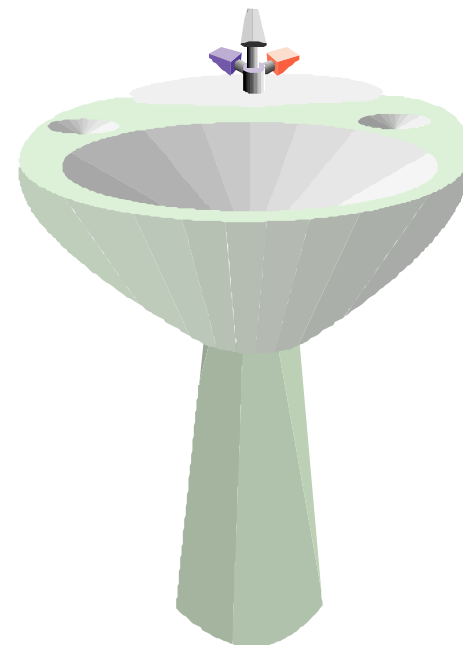
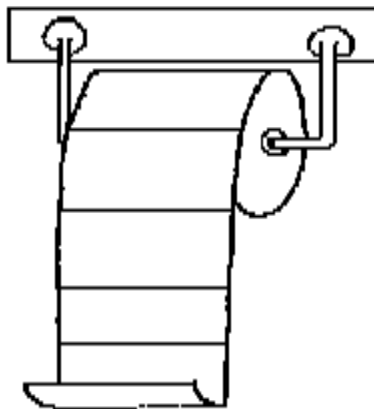
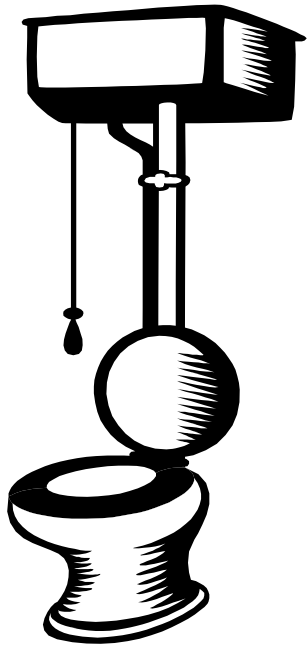

“Il mio vocabolario”: LA CASA
Come si chiama?

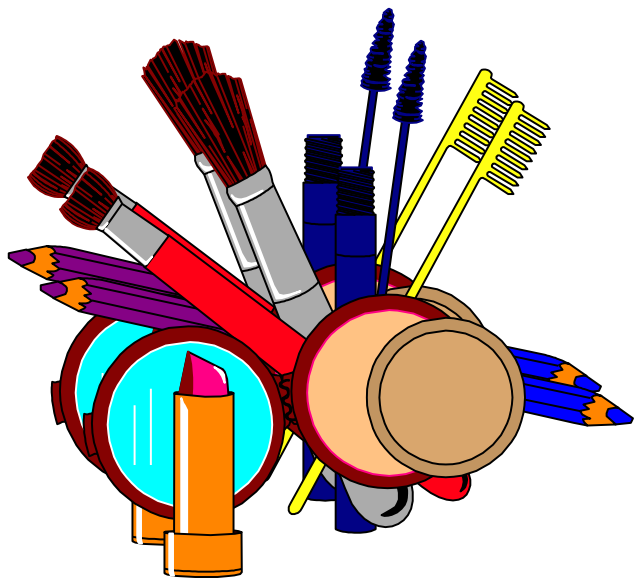

I cosmetici

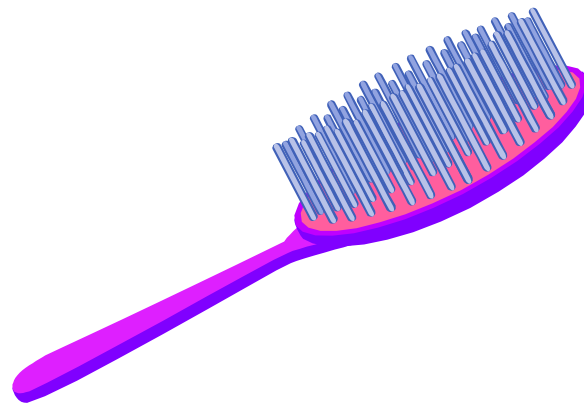

La spazzola

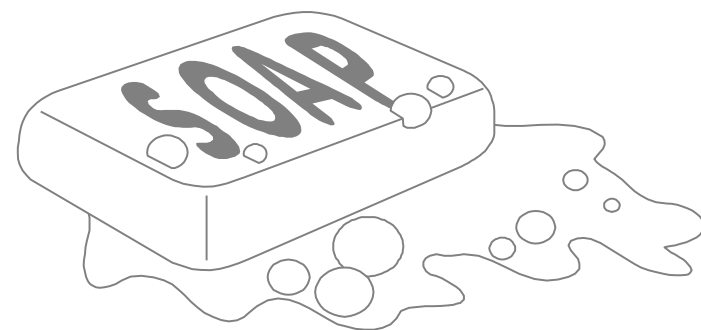

Il sapone

“Il mio vocabolario”: LA CASA
Far associare ogni parola all’immagine corrispondente.

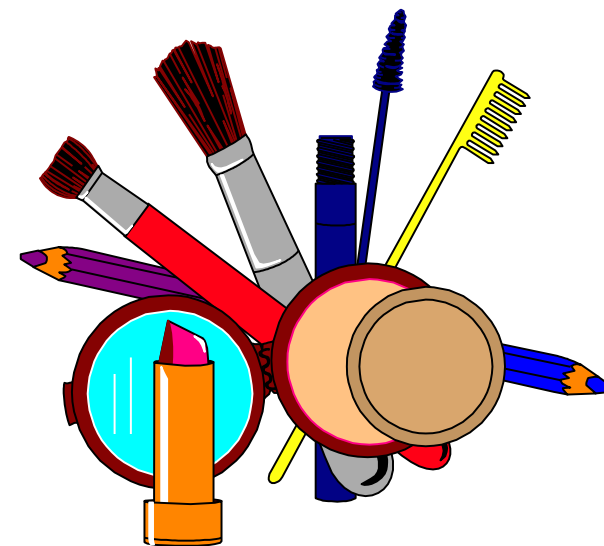
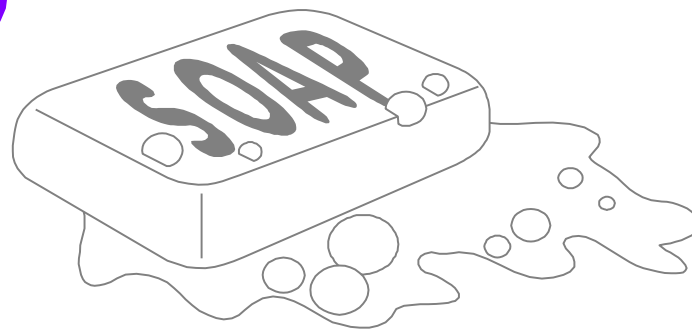
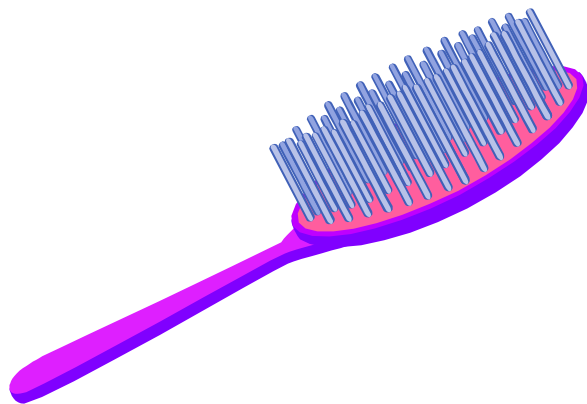

- I cosmetici
 - La spazzola
 - Il sapone

“Il mio vocabolario”: LA CASA
Far associare ogni parola all’immagine corrispondente.

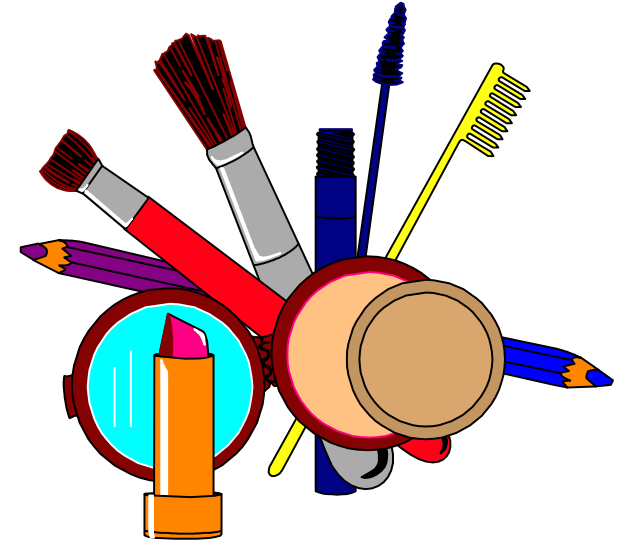
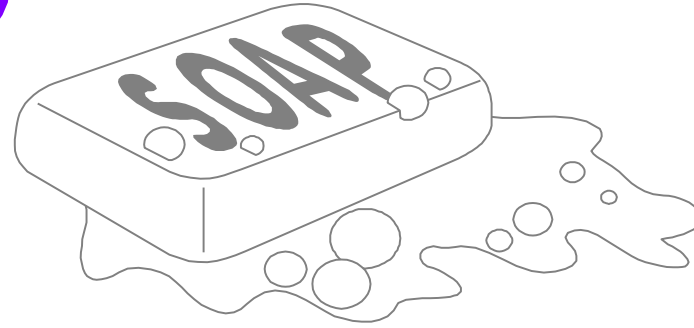
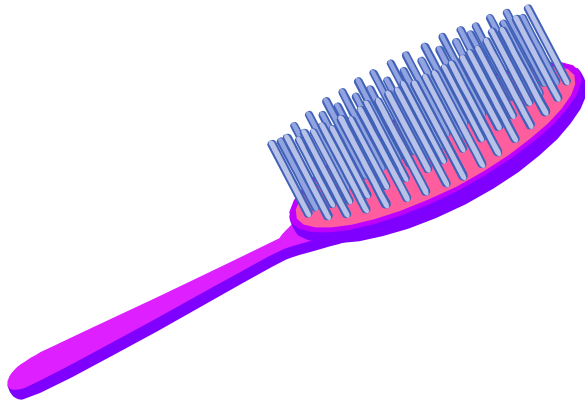

"Il mio vocabolario": LA CASA
Come si chiama?

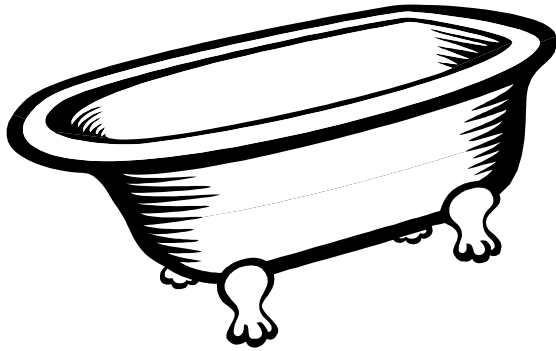

La vasca



La doccia



L'accappatoio

"Il mio vocabolario": LA CASA
Far associare ogni parola all'immagine corrispondente.

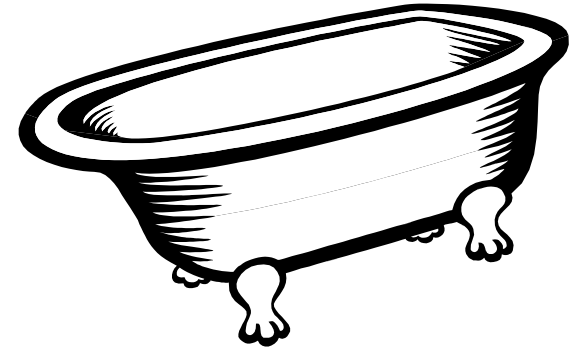

- La vasca
- La doccia
- L'accappatoio

"Il mio vocabolario": LA CASA
Far associare ogni parola all'immagine corrispondente.

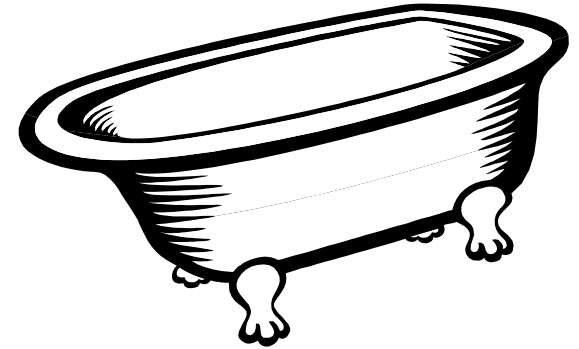

“Il mio vocabolario”: LA CASA
Come si chiama?

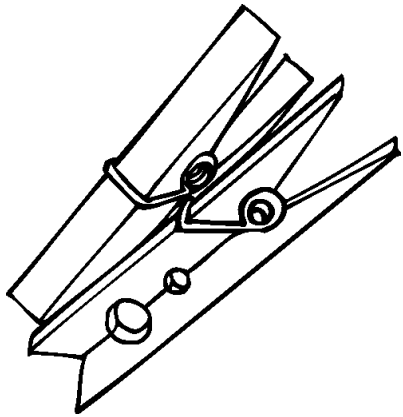

Le mollette

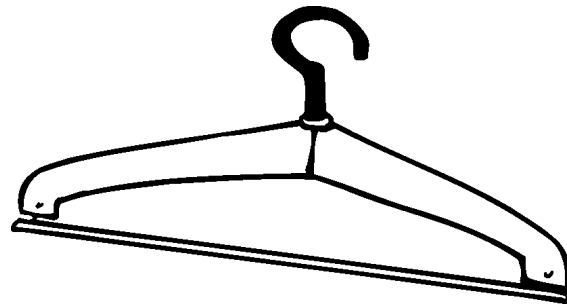

La gruccia

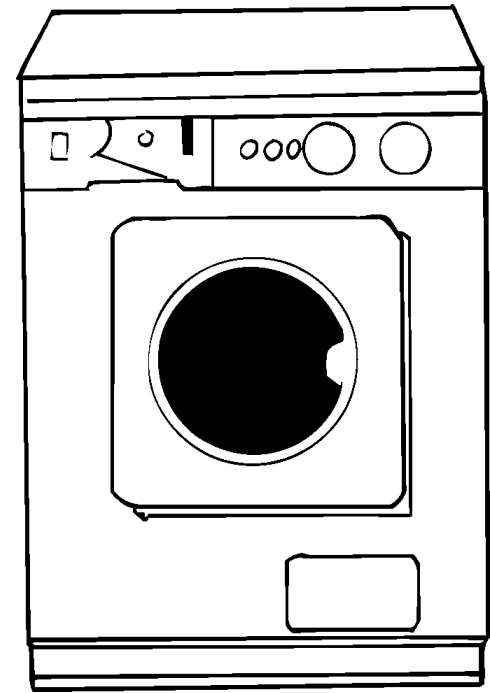

La lavatrice

“Il mio vocabolario”: LA CASA
Far associare ogni parola all’immagine corrispondente.

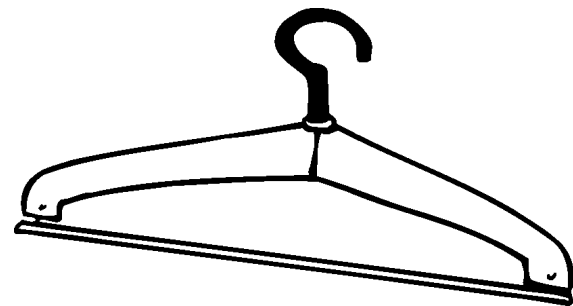
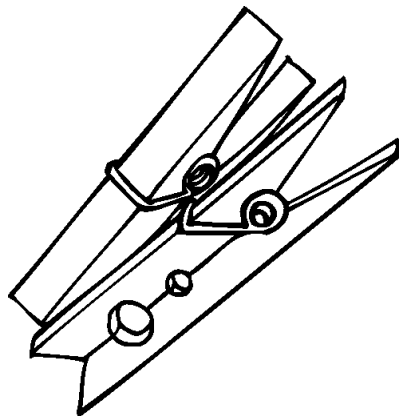
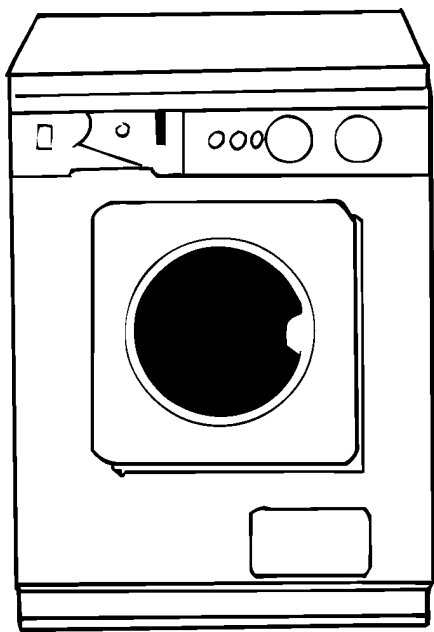

- Le mollette
- La gruccia
- La lavatrice

“Il mio vocabolario”: LA CASA
Far associare ogni parola all’immagine corrispondente.

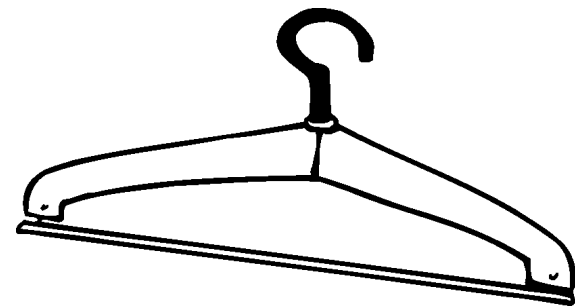
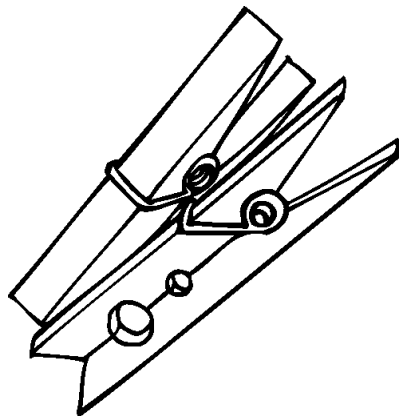

“Il mio vocabolario”: LA CASA
Come si chiama?

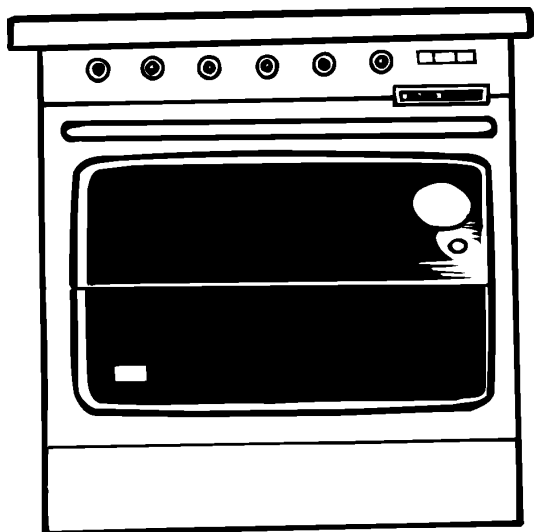

Il forno

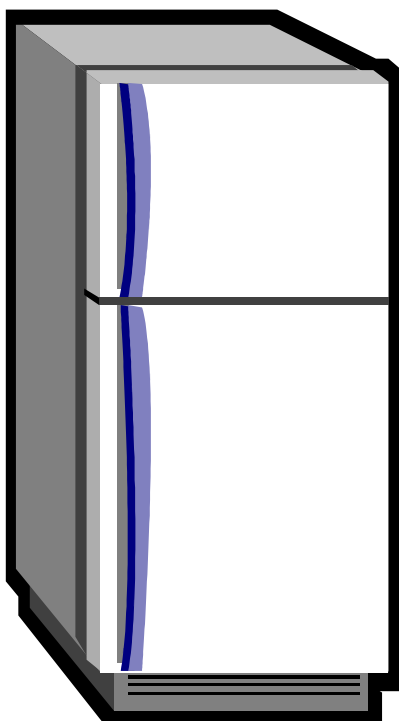

Il frigorifero

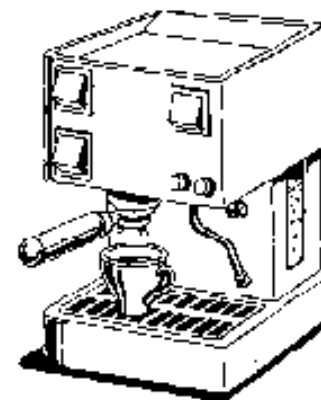

La macchina
del caffè

“Il mio vocabolario”: LA CASA
Far associare ogni parola all’immagine corrispondente.

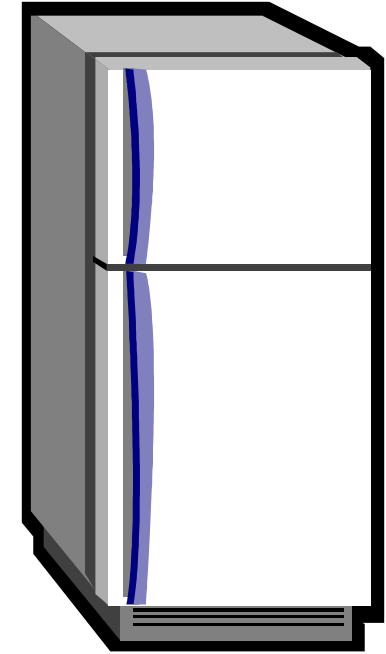
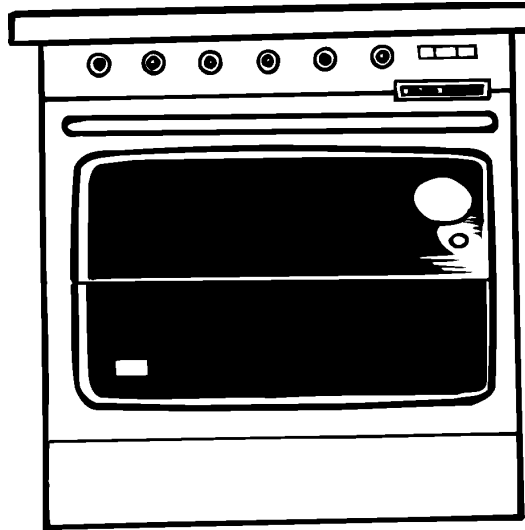
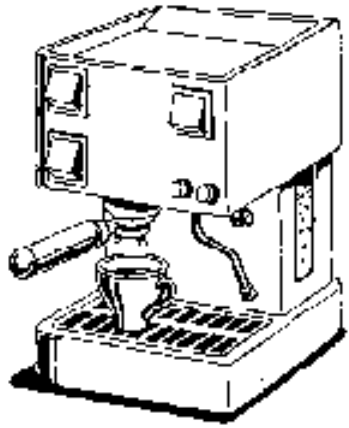

- Il forno
- Il frigorifero
- La macchina del caffè

“Il mio vocabolario”: LA CASA
Far associare ogni parola all’immagine corrispondente.

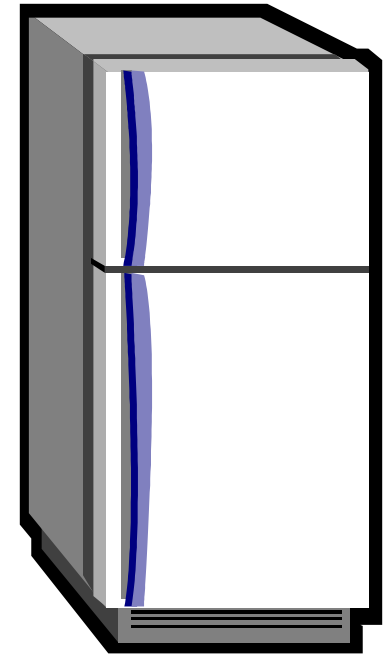
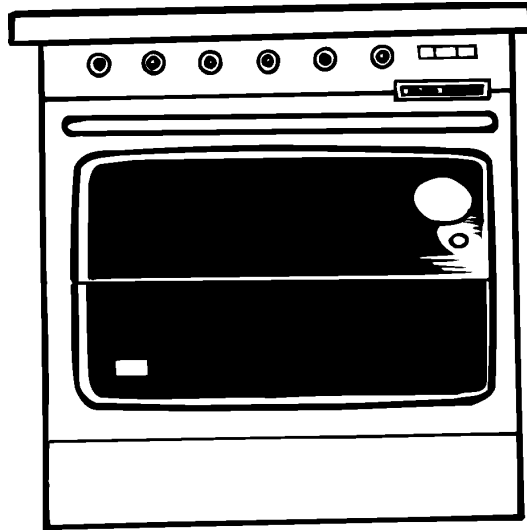
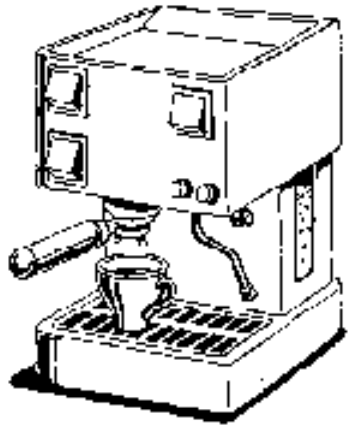

“Il mio vocabolario”: LA CASA
Come si chiama?

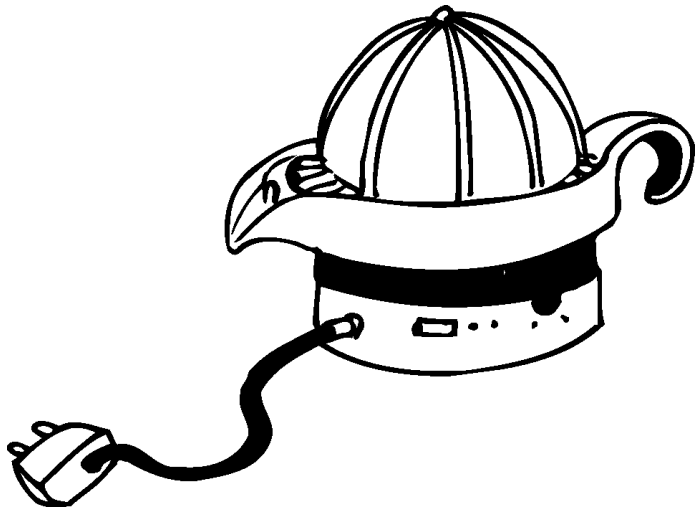

Lo spremiagrumi



La caffettiera

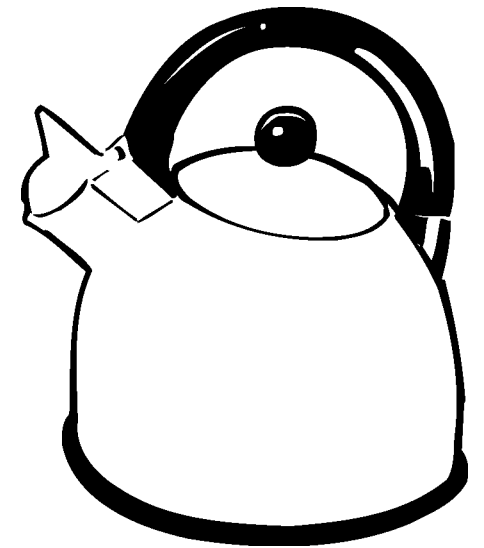

La teiera

“Il mio vocabolario”: LA CASA
Far associare ogni parola all’immagine corrispondente.

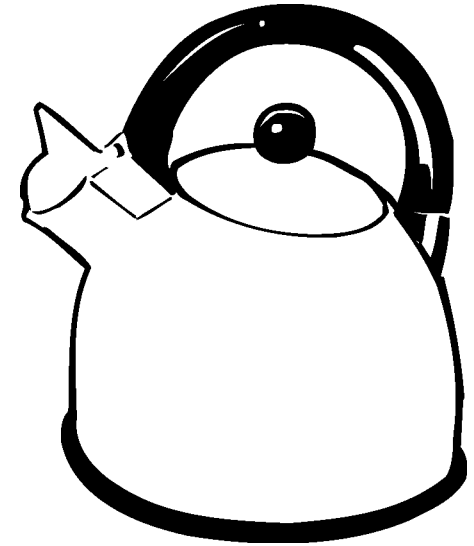
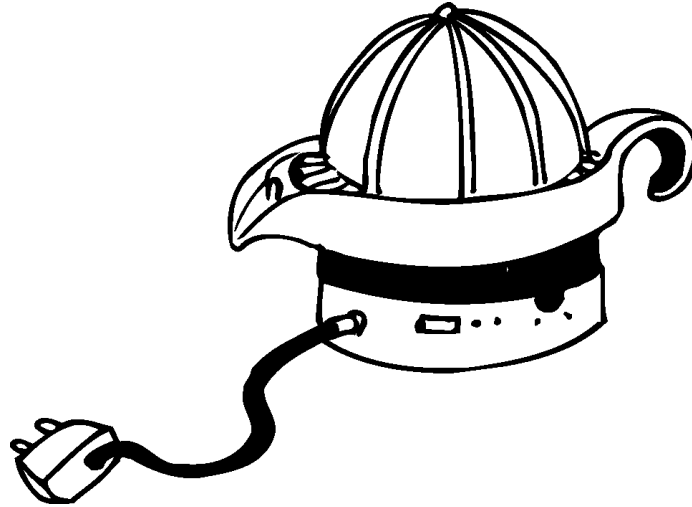

- La teiera
- La caffettiera
- Lo spremiagrumi

“Il mio vocabolario”: LA CASA
Far associare ogni parola all’immagine corrispondente.

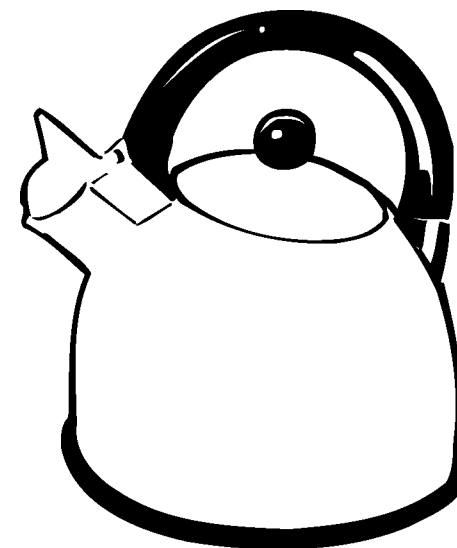
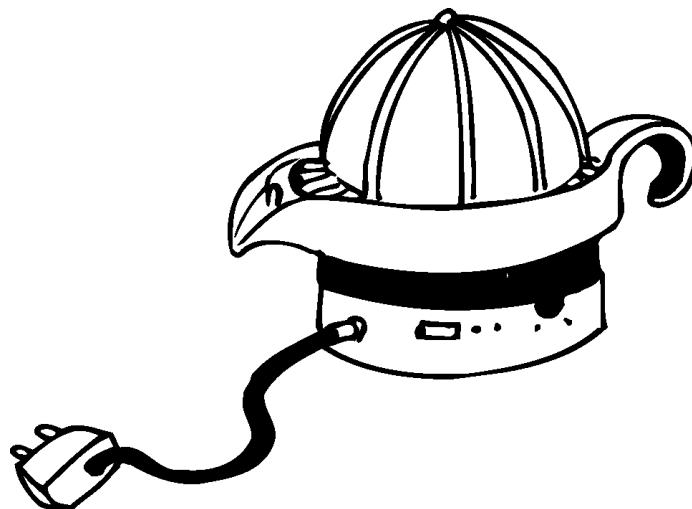

“Il mio vocabolario”: LA CASA
Come si chiama?

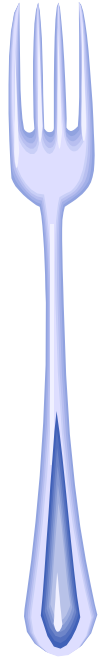

La forchetta



Il coltello



Il cucchiaino

"Il mio vocabolario": LA CASA
Far associare ogni parola all'immagine corrispondente.

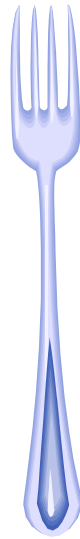

- La forchetta
- Il coltello
- Il cucchiaio

“Il mio vocabolario”: LA CASA
Far associare ogni parola all’immagine corrispondente.

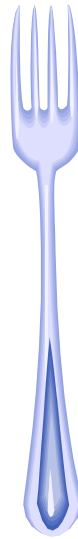

"Il mio vocabolario": LA CASA
Come si chiama?

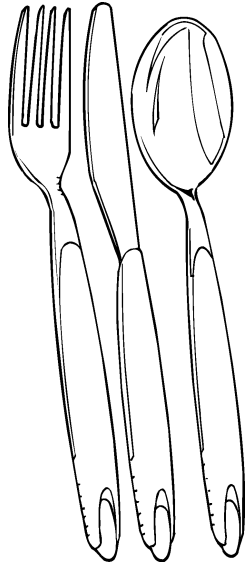

Le posate

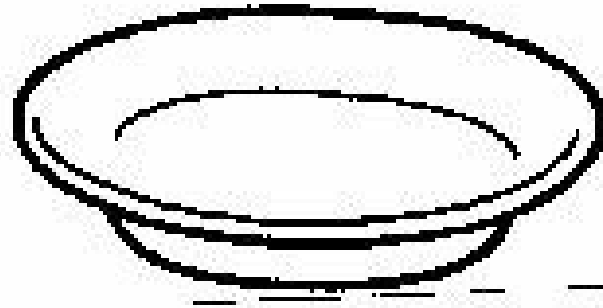

Il piatto

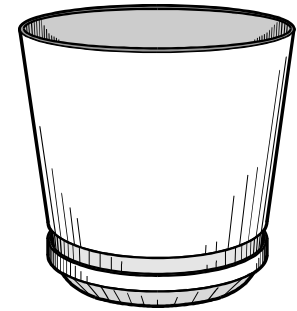

Il bicchiere

“Il mio vocabolario”: LA CASA
Far associare ogni parola all’immagine corrispondente.

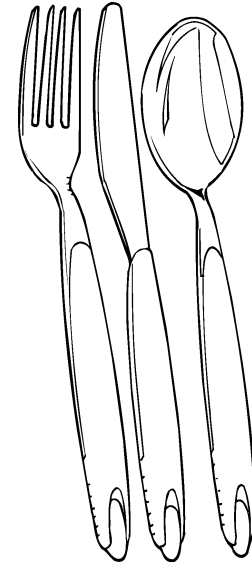
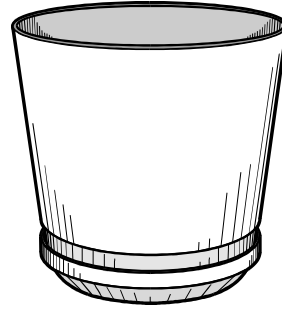
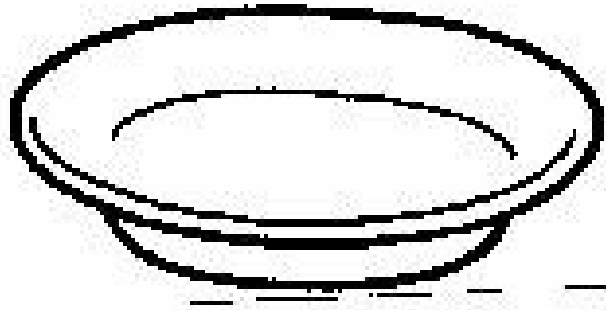

- Il bicchiere
 - Le posate
 - Il piatto

“Il mio vocabolario”: LA CASA
Far associare ogni parola all’immagine corrispondente.

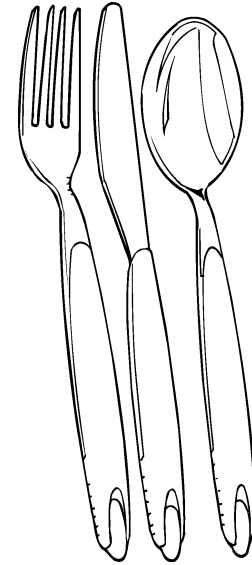
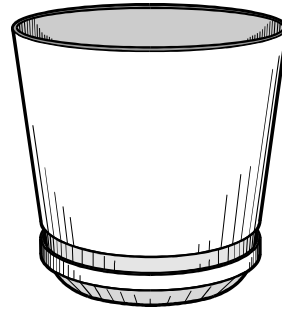
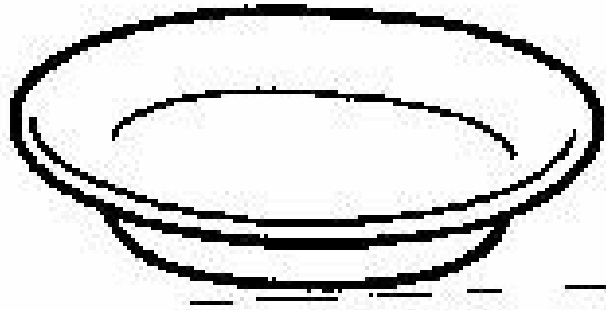

"Il mio vocabolario": LA CASA
Come si chiama?

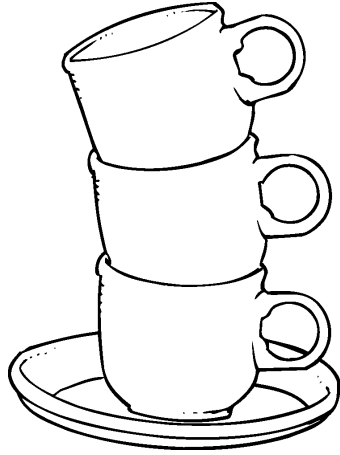

Le tazze

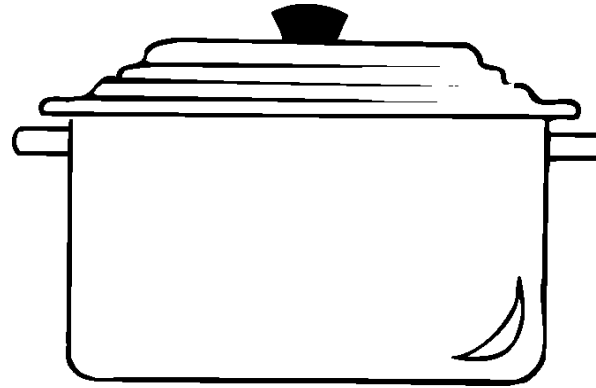

La pentola

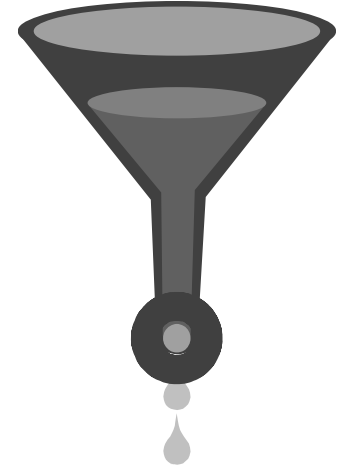

L'imbuto

"Il mio vocabolario": LA CASA
Far associare ogni parola all'immagine corrispondente.

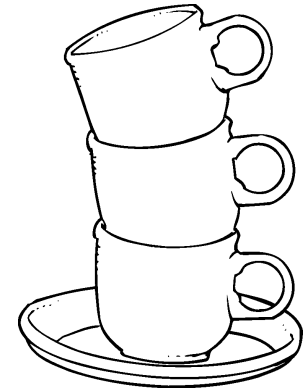
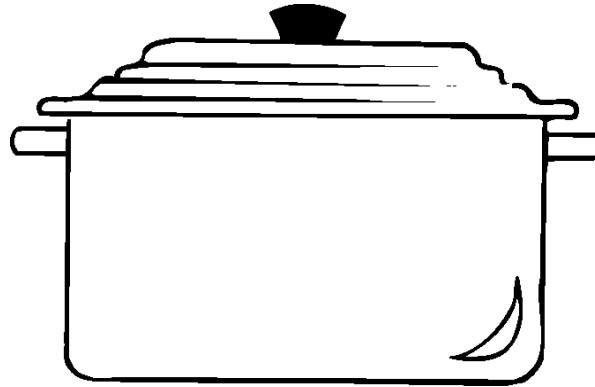
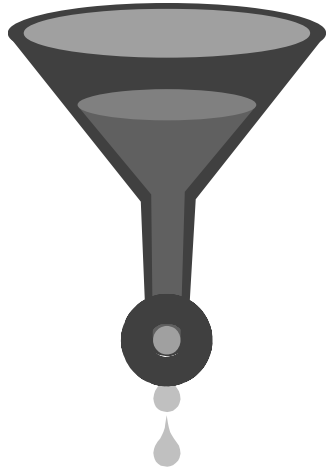

- Le tazze
- L'imbuto
- La pentola

"Il mio vocabolario": LA CASA
Far associare ogni parola all'immagine corrispondente.

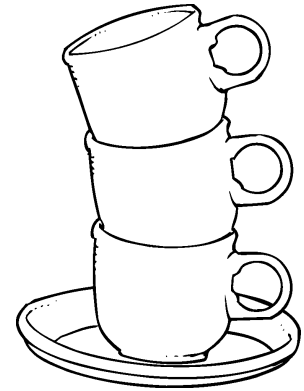
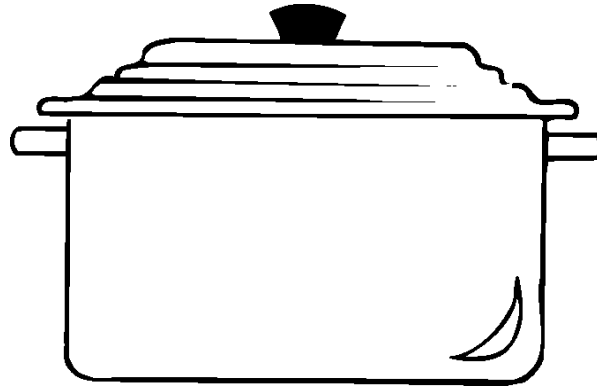
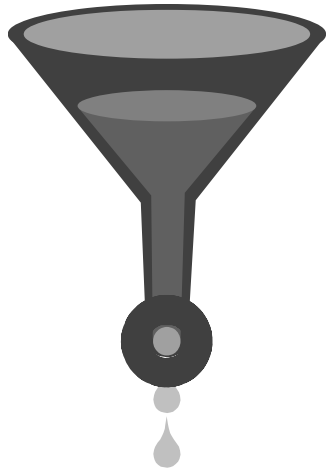

“Il mio vocabolario”: LA CASA
Come si chiama?

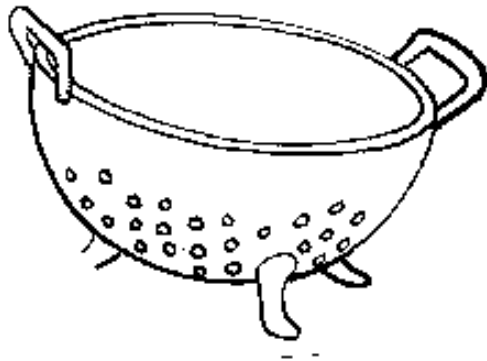

Lo scolapasta

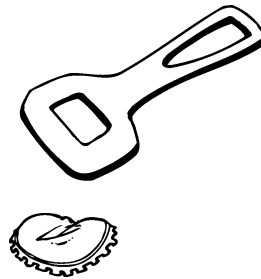

L'apribottiglie



Il mestolo

“Il mio vocabolario”: LA CASA
Far associare ogni parola all'immagine corrispondente.

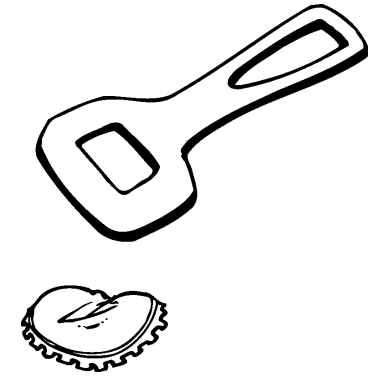
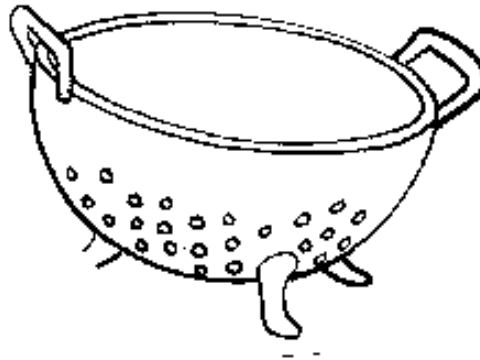

- L'apribottiglie
- Il mestolo
- Lo scolapasta

"Il mio vocabolario": LA CASA
Far associare ogni parola all'immagine corrispondente.

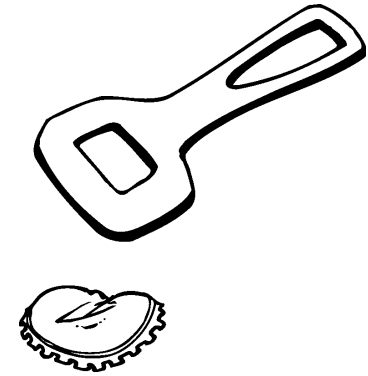
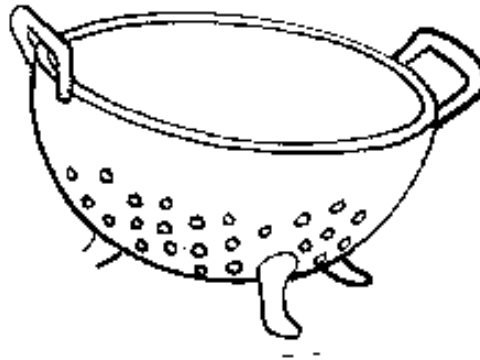
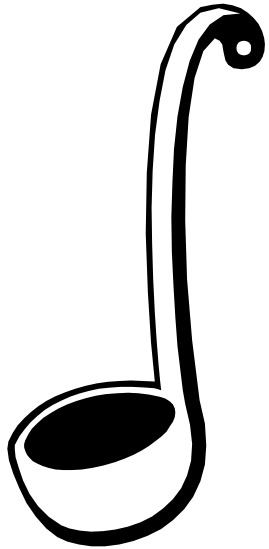

"Il mio vocabolario": LA CASA
Come si chiama?

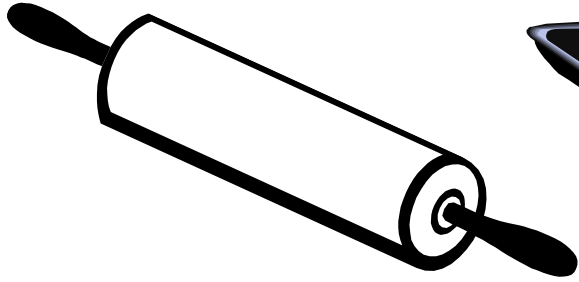

Il matterello



La teglia

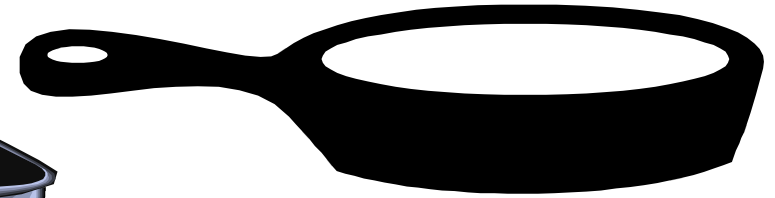

La padella

“Il mio vocabolario”: LA CASA
Far associare ogni parola all’immagine corrispondente.

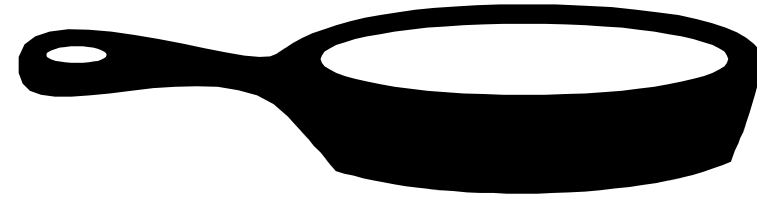
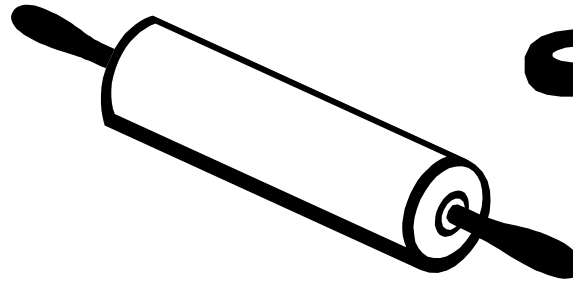

- Il matterello

- La padella

- La teglia

“Il mio vocabolario”: LA CASA
Far associare ogni parola all’immagine corrispondente.

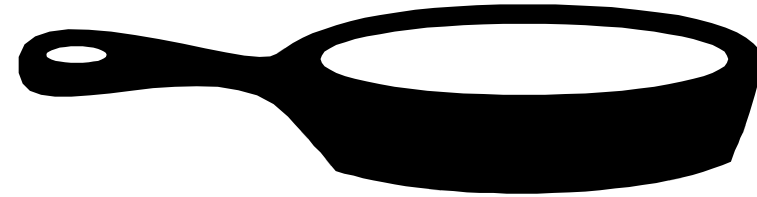
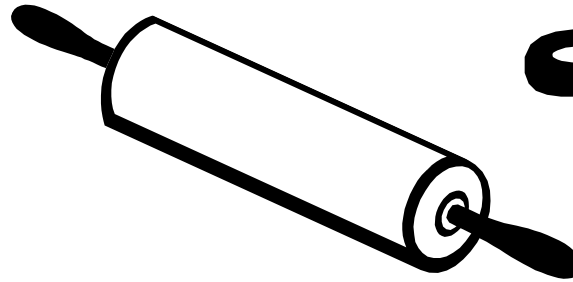
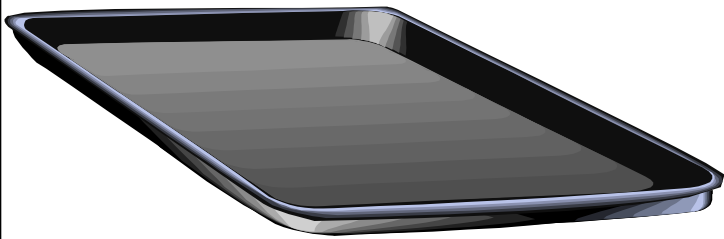

"Il mio vocabolario": LA CASA
Come si chiama?

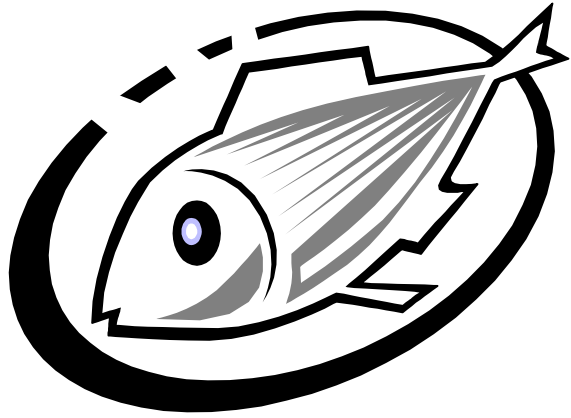

Il pesce

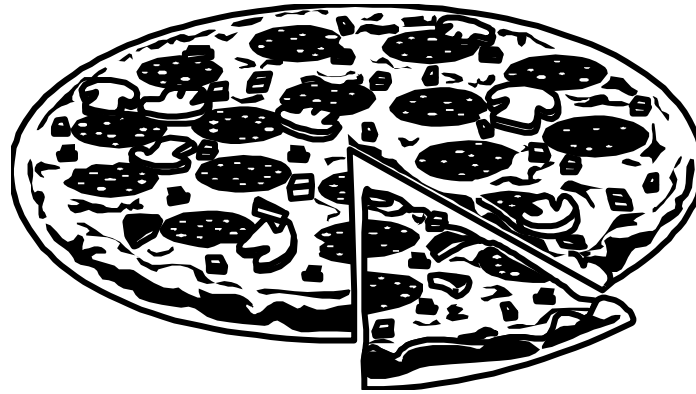

La pizza

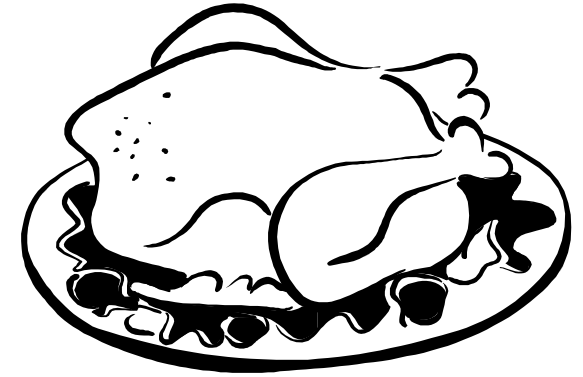

Il pollo

“Il mio vocabolario”: LA CASA
Far associare ogni parola all’immagine corrispondente.

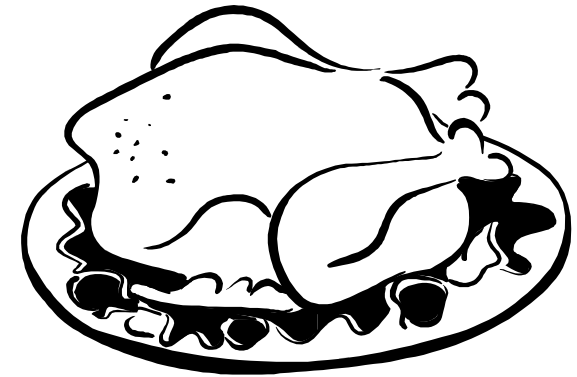
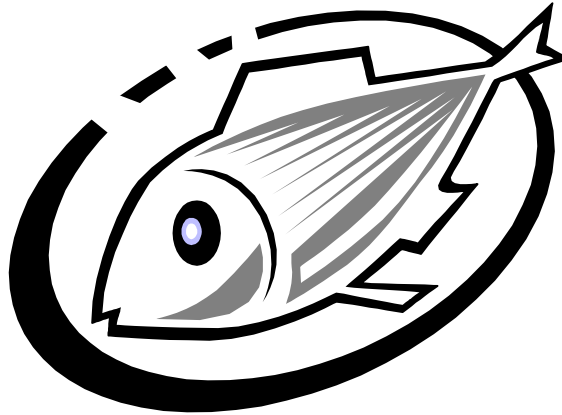
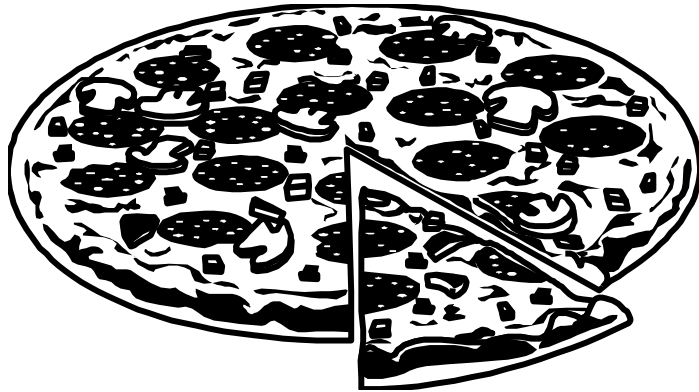

- Il pollo
- La pizza
- Il pesce

“Il mio vocabolario”: LA CASA
Far associare ogni parola all’immagine corrispondente.

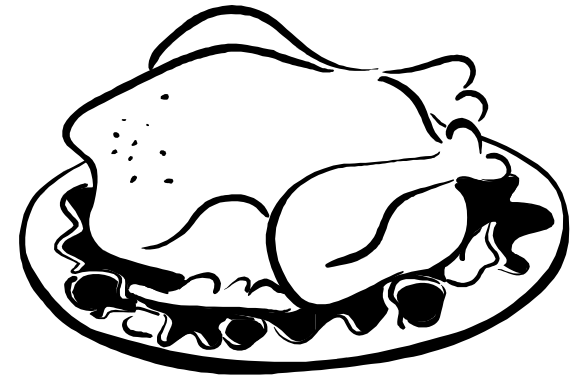
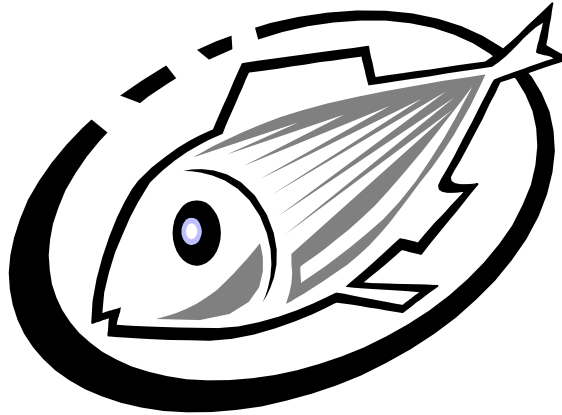
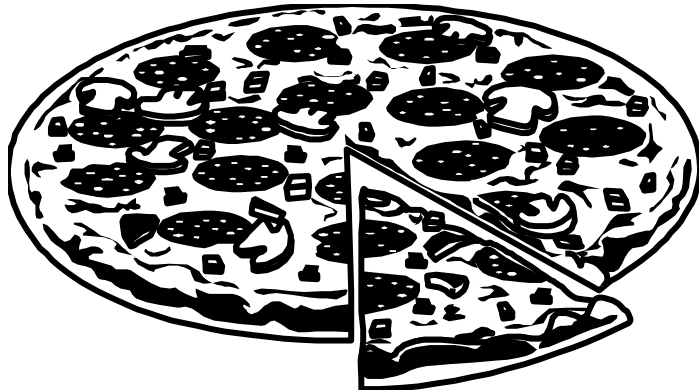

“Il mio vocabolario”: LA CASA
Come si chiama?

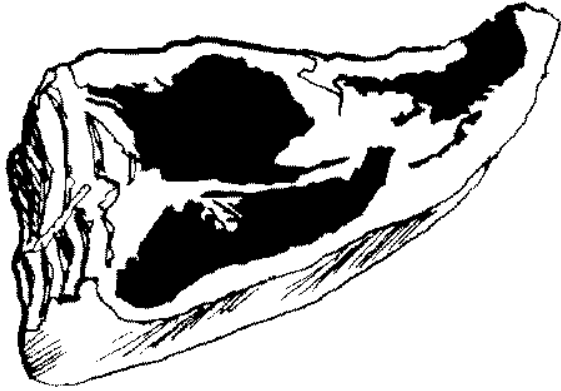

La carne

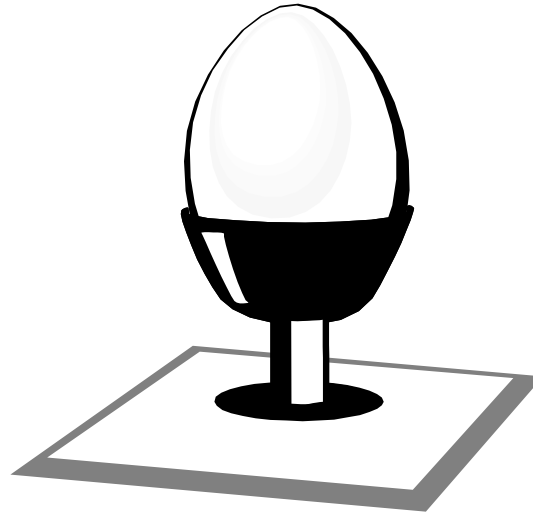

L'uovo

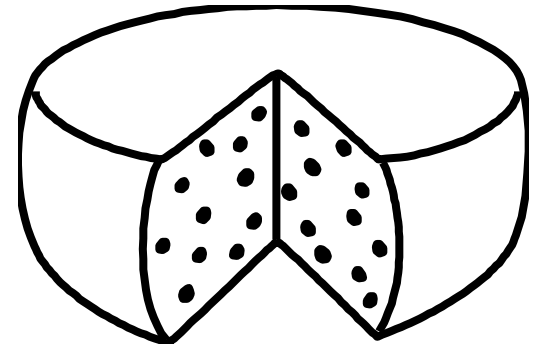

Il formaggio

"Il mio vocabolario": LA CASA
Far associare ogni parola all'immagine corrispondente.

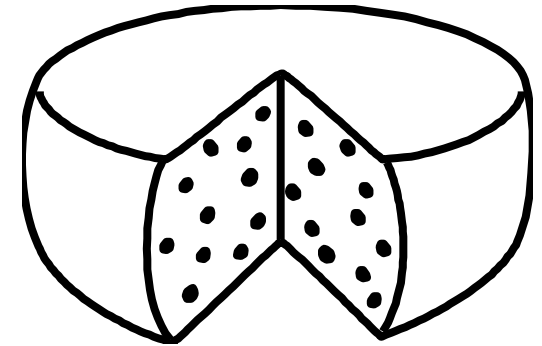
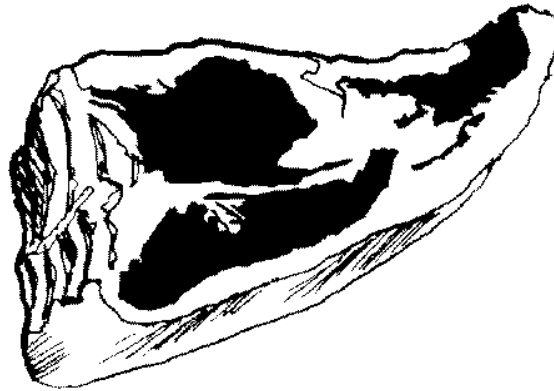
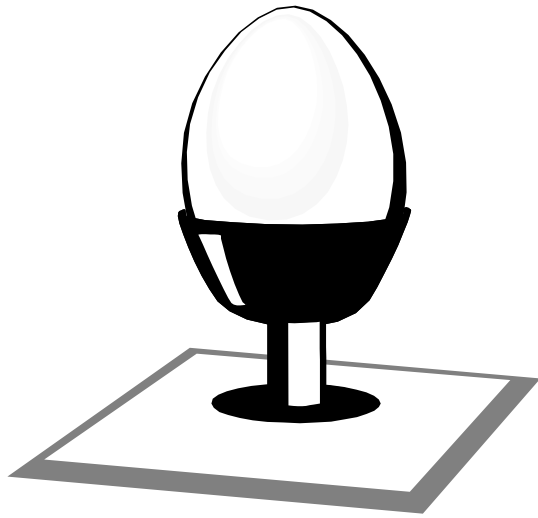

La carne

L'uovo

Il formaggio

"Il mio vocabolario": LA CASA
Far associare ogni parola all'immagine corrispondente.

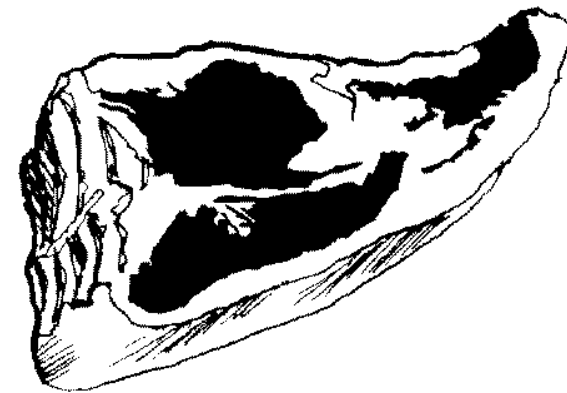
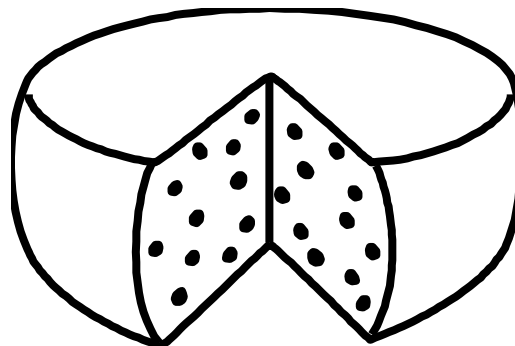
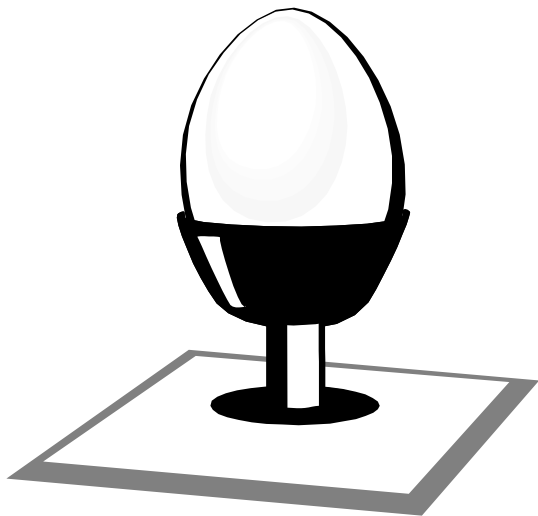

"Il mio vocabolario": LA CASA
Come si chiama?



Il gelato

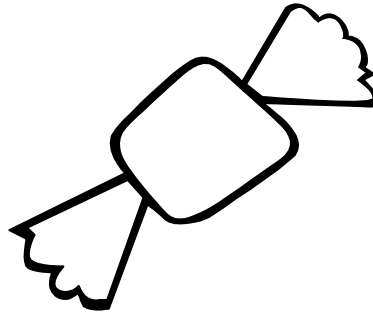

La caramella

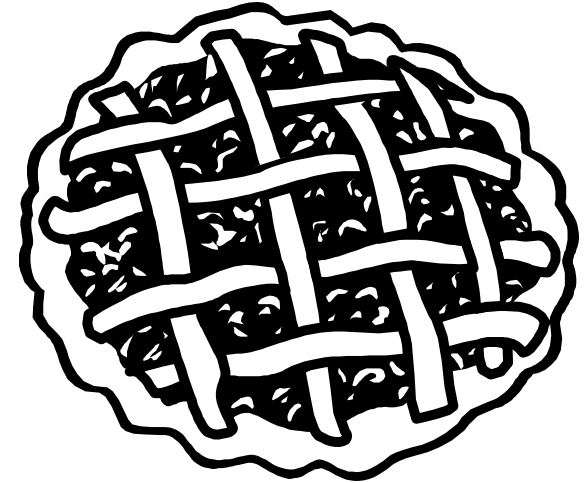

La crostata

“Il mio vocabolario”: LA CASA
Far associare ogni parola all’immagine corrispondente.

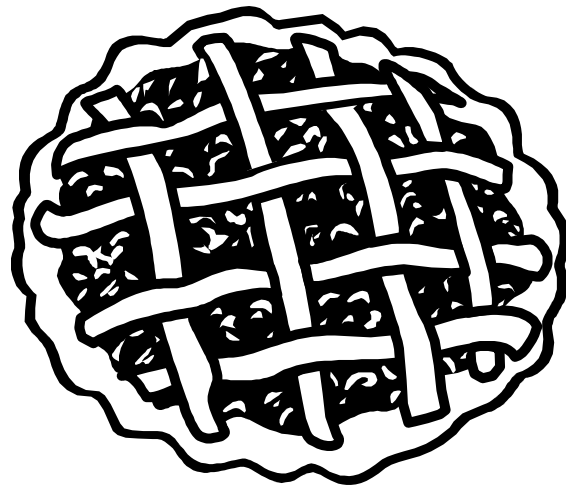
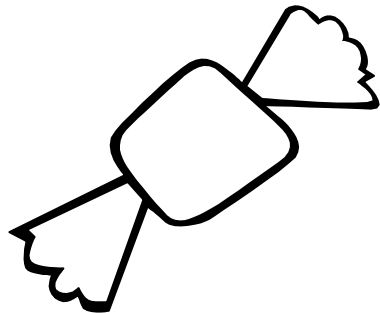

- La crostata
 - Il gelato
- La caramella

“Il mio vocabolario”: LA CASA
Far associare ogni parola all’immagine corrispondente.

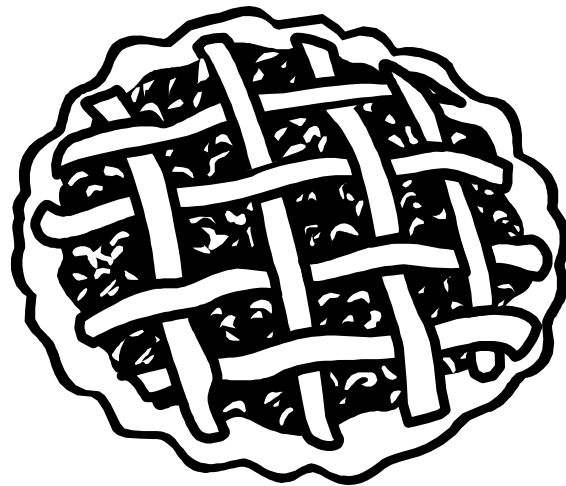
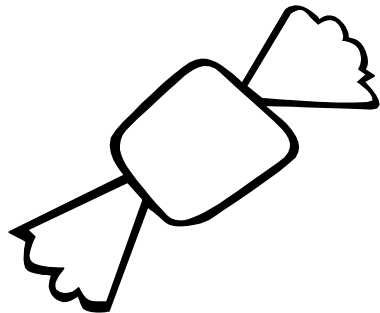

"Il mio vocabolario": LA CASA
Come si chiama?

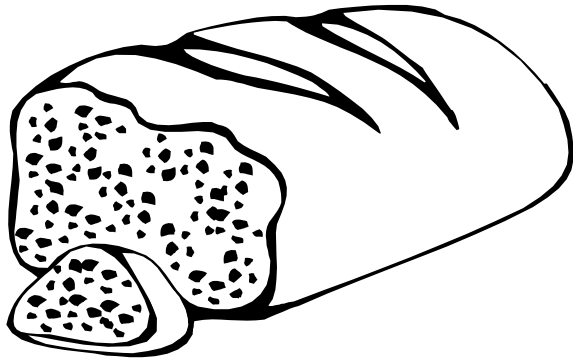

Il pane

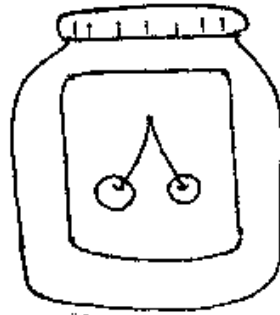

La marmellata

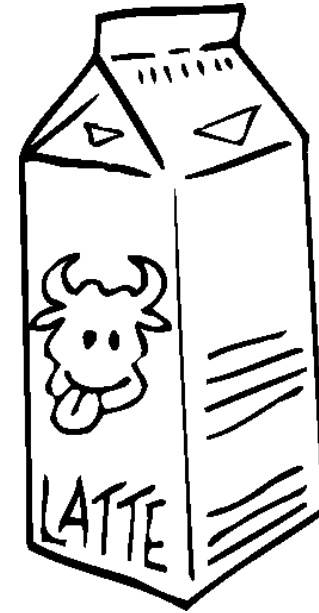

Il latte

“Il mio vocabolario”: LA CASA
Far associare ogni parola all’immagine corrispondente.

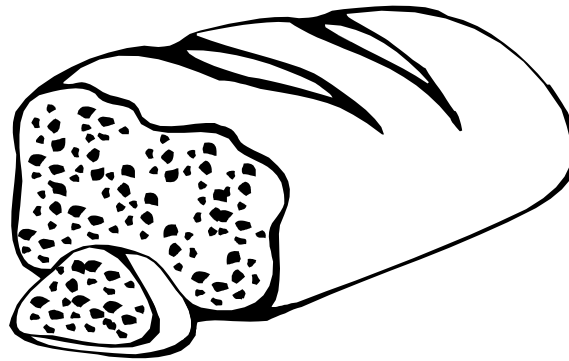
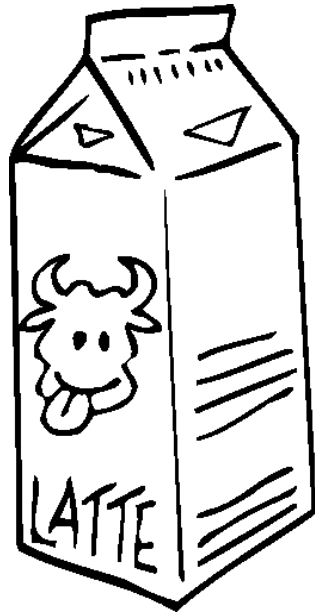

- Il pane
- La marmellata
- Il latte

“Il mio vocabolario”: LA CASA
Far associare ogni parola all’immagine corrispondente.

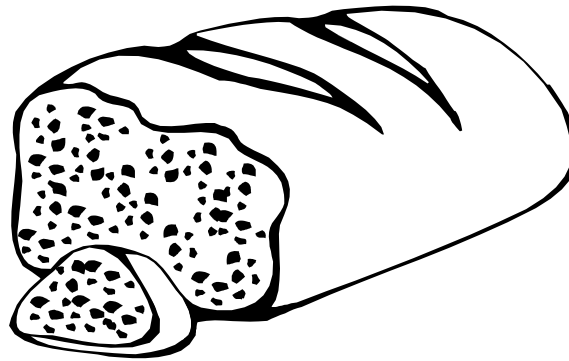
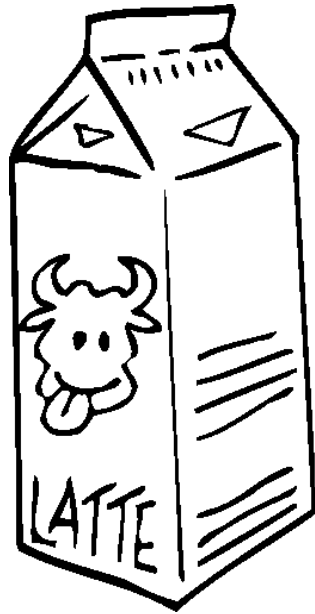

“Il mio vocabolario”: LA CASA
Come si chiama?

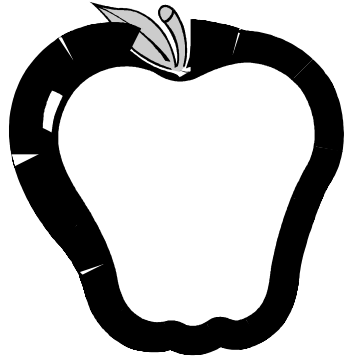

La mela

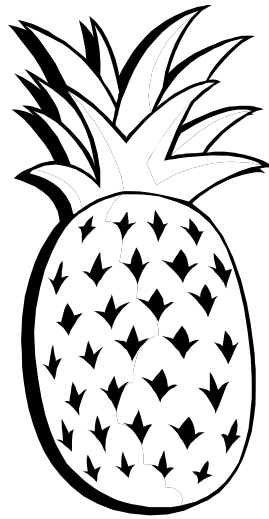

L'ananas

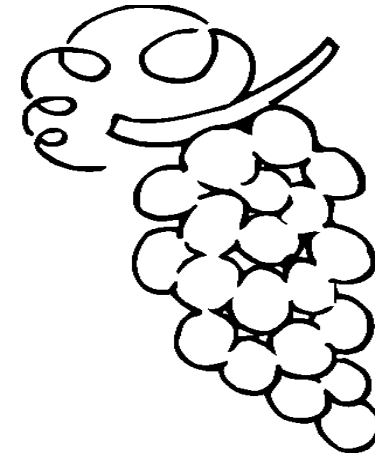

L'uva

"Il mio vocabolario": LA CASA
Far associare ogni parola all'immagine corrispondente.

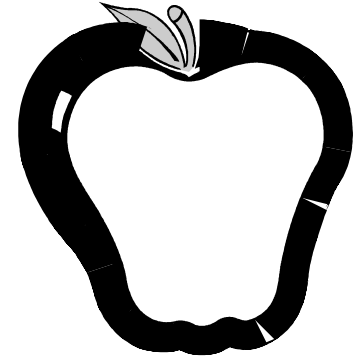
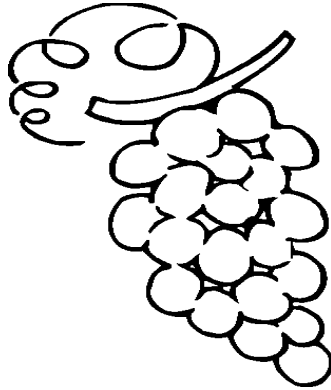
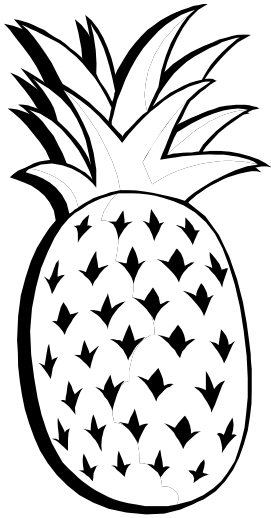

- La mela
- L'ananas
- L'uva

"Il mio vocabolario": LA CASA
Far associare ogni parola all'immagine corrispondente.

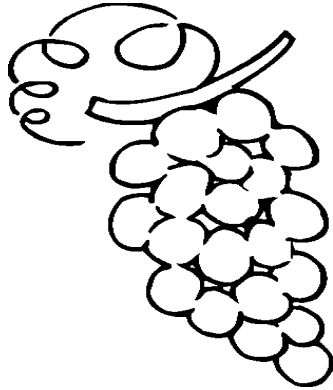
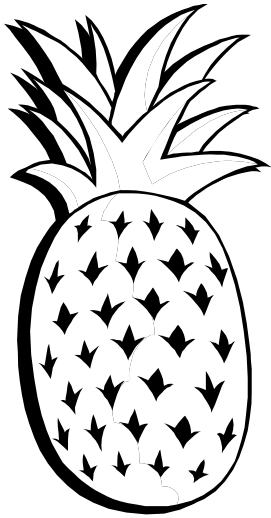

"Il mio vocabolario": LA CASA
Come si chiama?

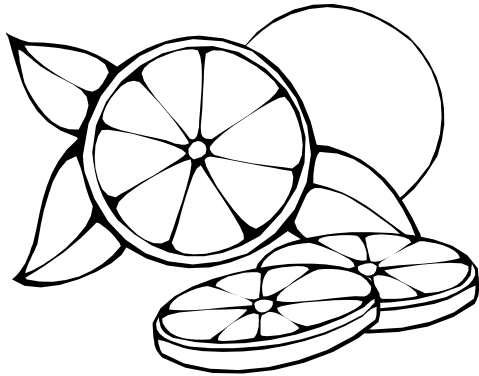

Il limone

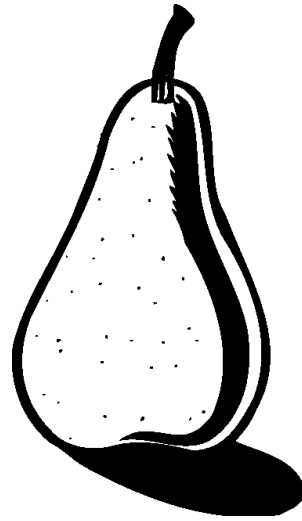

La pera



Le ciliege

“Il mio vocabolario”: LA CASA
Far associare ogni parola all’immagine corrispondente.

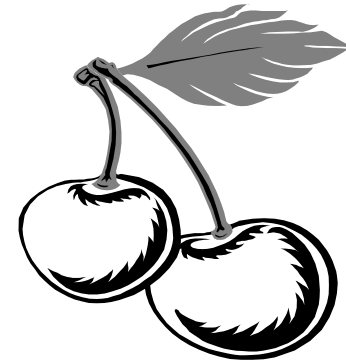
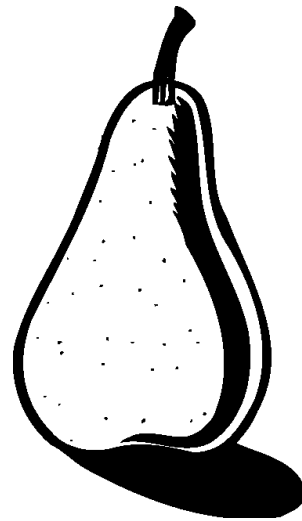
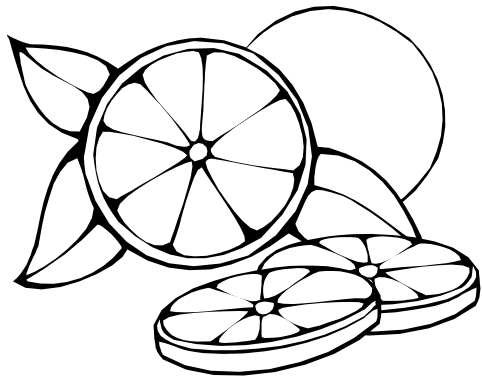

Il limone

La pera

Le ciliege

“Il mio vocabolario”: LA CASA
Far associare ogni parola all’immagine corrispondente.

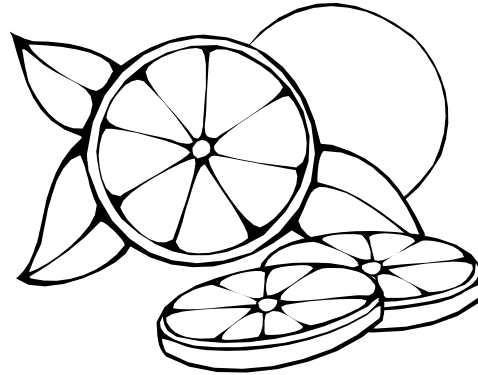
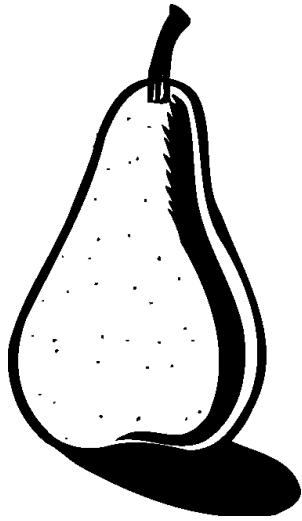

“Il mio vocabolario”: LA CASA
Come si chiama?

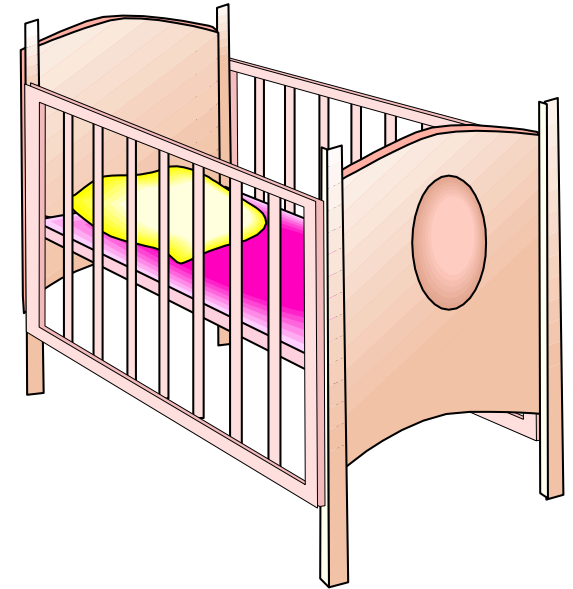
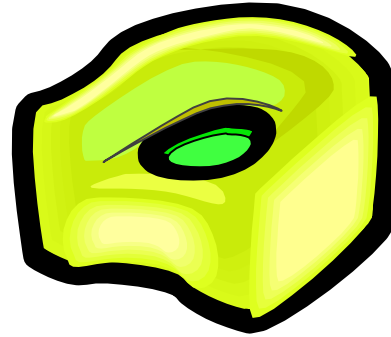

- La culla

- La spilla da balia

- Il vasino

“Il mio vocabolario”: LA CASA
Far associare ogni parola all’immagine corrispondente.

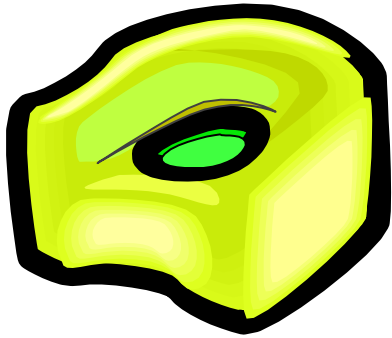

Il vasino

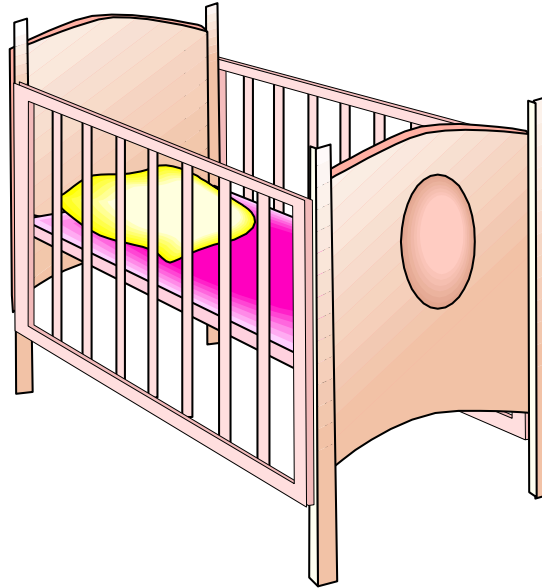

La culla



La spilla da balia

“Il mio vocabolario”: LA CASA
Far associare ogni parola all’immagine corrispondente.

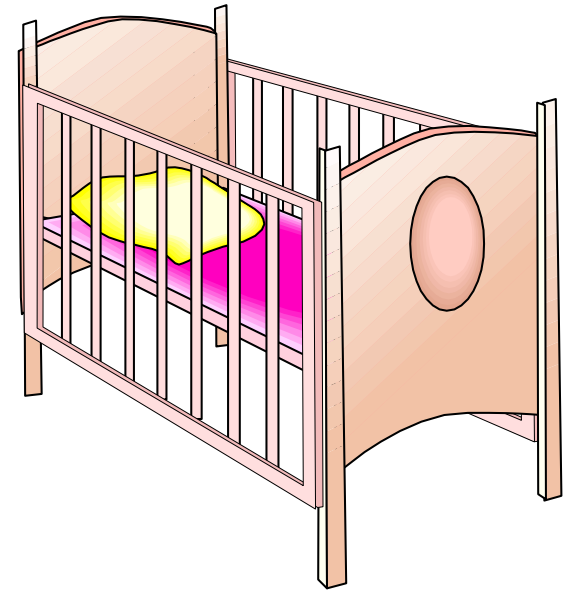
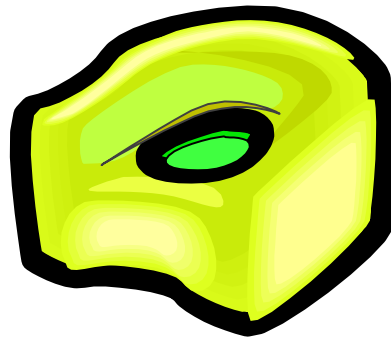

"Il mio vocabolario": LA CASA
Come si chiama?

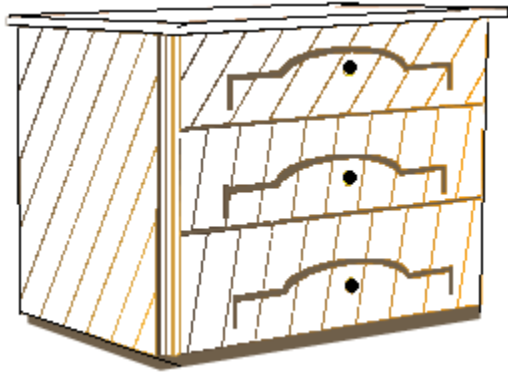

La cassettera

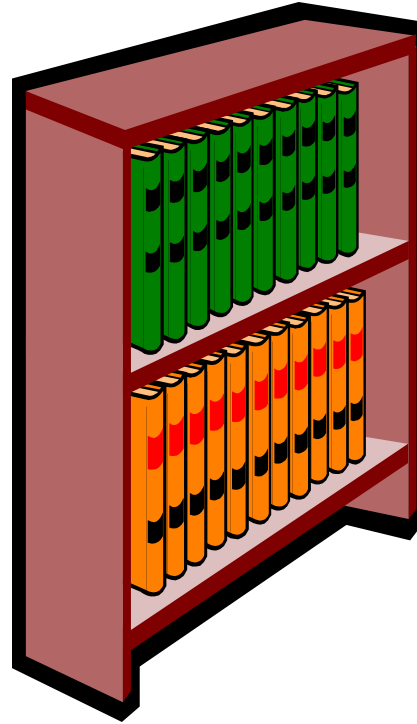

La libreria

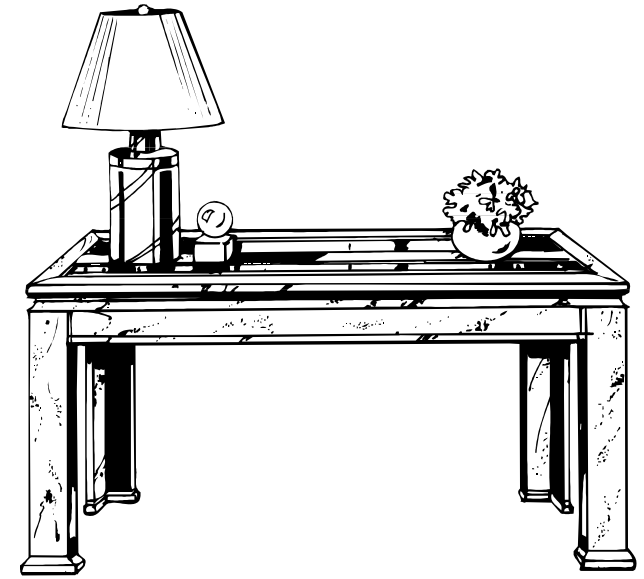

La scrivania

“Il mio vocabolario”: LA CASA
Far associare ogni parola all’immagine corrispondente.

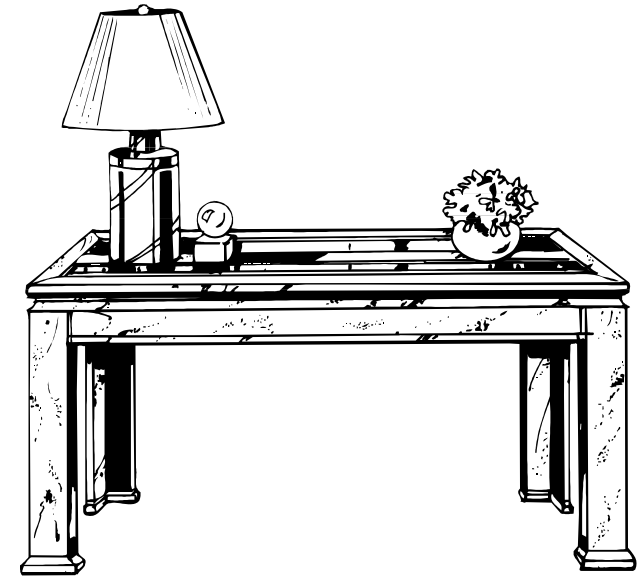
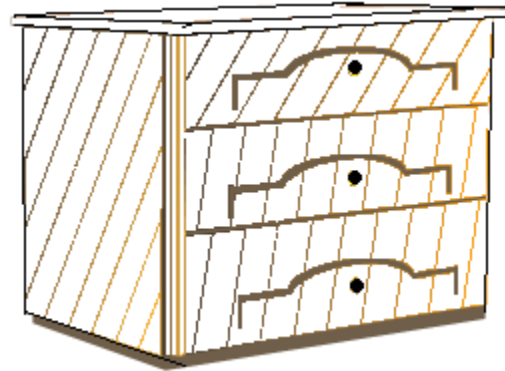
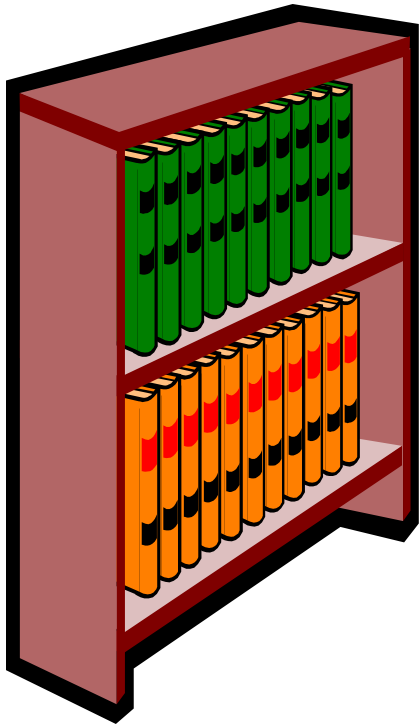

La cassettera

La libreria

La scrivania

“Il mio vocabolario”: LA CASA
Far associare ogni parola all’immagine corrispondente.

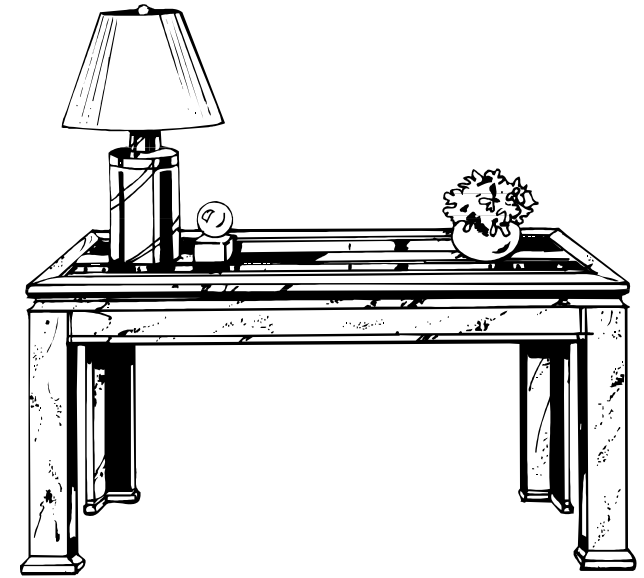
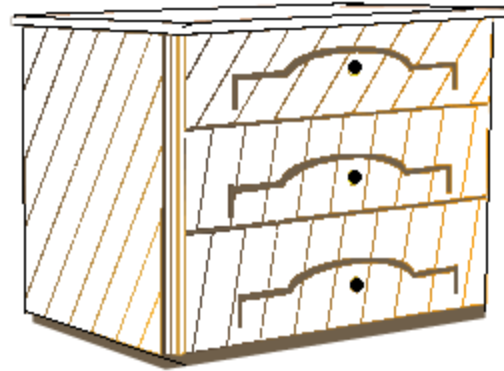
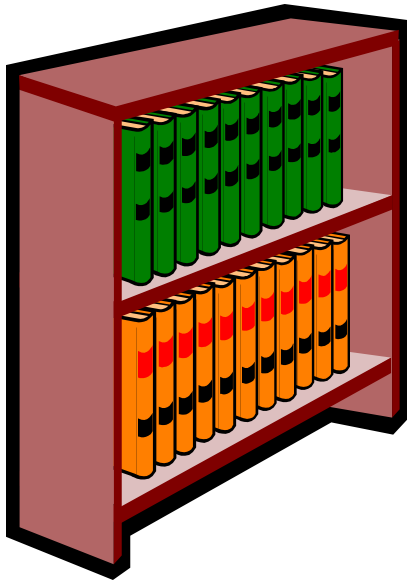

“Il mio vocabolario”: LA CASA
Come si chiama?



La calza

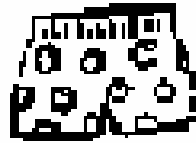

Le mutande



La canottiera

“Il mio vocabolario”: LA CASA
Far associare ogni parola all’immagine corrispondente.

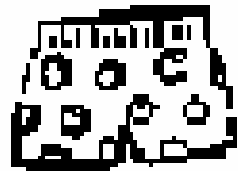

- La canottiera
 - le mutande
- La calza

“Il mio vocabolario”: LA CASA
Far associare ogni parola all’immagine corrispondente.

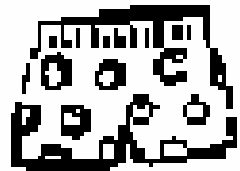

"Il mio vocabolario": LA CASA
Come si chiama?

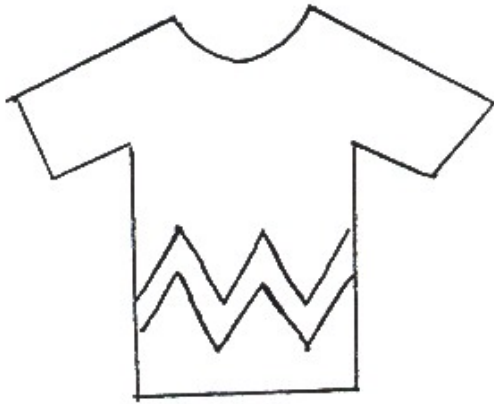

La maglietta



La scarpa



I pantaloni

“Il mio vocabolario”: LA CASA
Far associare ogni parola all’immagine corrispondente.



La maglietta

La scarpa

I pantaloni

“Il mio vocabolario”: LA CASA
Far associare ogni parola all’immagine corrispondente.



“Il mio vocabolario”: LA CASA
Come si chiama?



Il pigiama

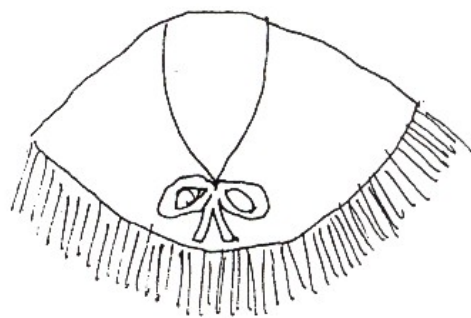

Lo scialle

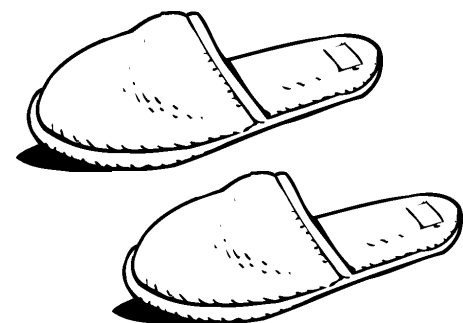

Le pantofole

“Il mio vocabolario”: LA CASA
Far associare ogni parola all’immagine corrispondente.

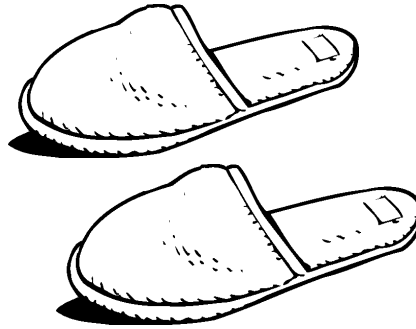
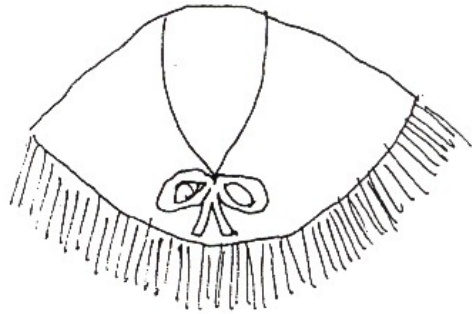

- Le pantofole
 - Il pigiama
 - Lo scialle

“Il mio vocabolario”: LA CASA
Far associare ogni parola all’immagine corrispondente.

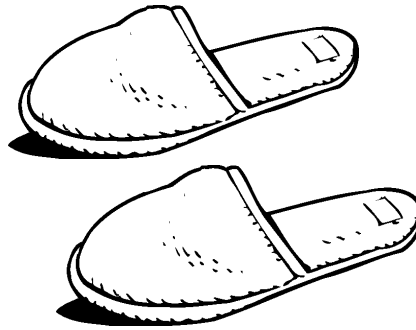
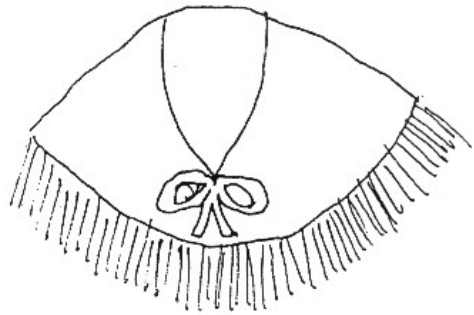

"Il mio vocabolario": LA CASA
Come si chiama?



Il maglione

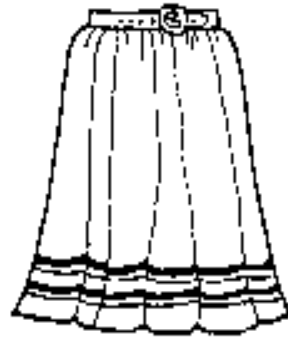

La gonna



Il vestito

“Il mio vocabolario”: LA CASA
Far associare ogni parola all’immagine corrispondente.

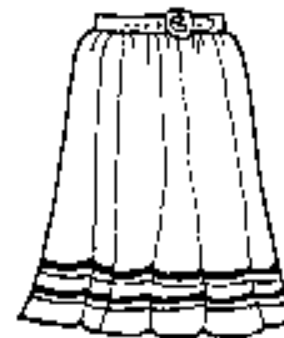

- La gonna
- Il vestito
- Il maglione

“Il mio vocabolario”: LA CASA
Far associare ogni parola all’immagine corrispondente.

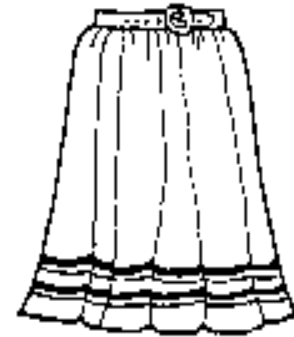

"Il mio vocabolario": LA CASA
Come si chiama?

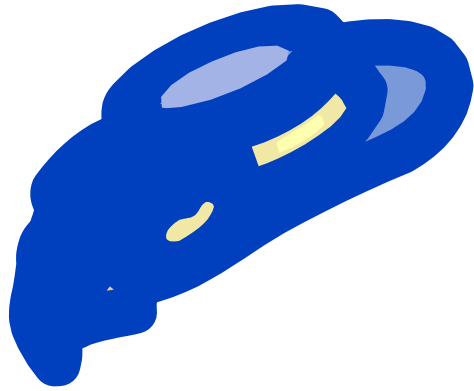

Il cappello



Gli stivali

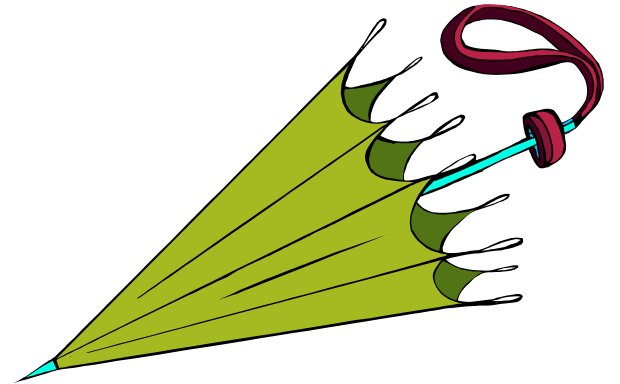

L'ombrello

"Il mio vocabolario": LA CASA
Far associare ogni parola all'immagine corrispondente.

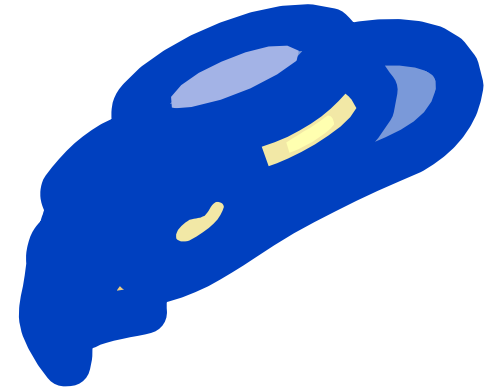
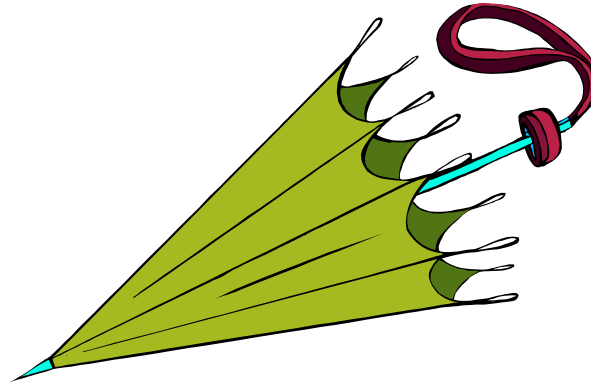

- Il cappello
- Gli stivali
- L'ombrello

"Il mio vocabolario": LA CASA
Far associare ogni parola all'immagine corrispondente.

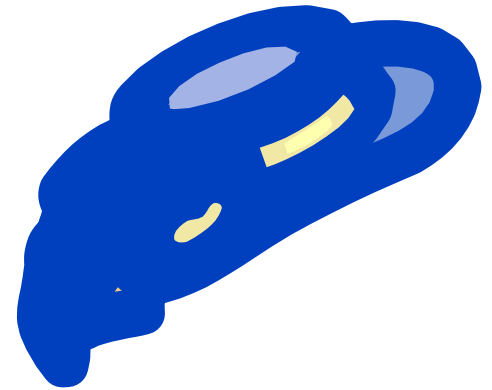
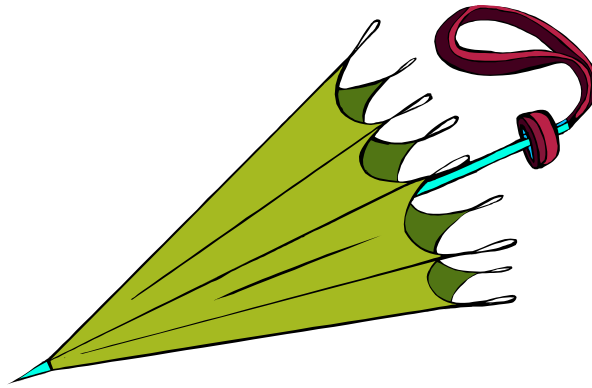

"Il mio vocabolario": LA CASA
Come si chiama?



La cravatta

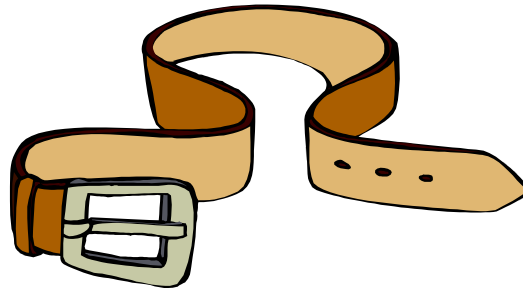

La cintura



I guanti

“Il mio vocabolario”: LA CASA
Far associare ogni parola all’immagine corrispondente.

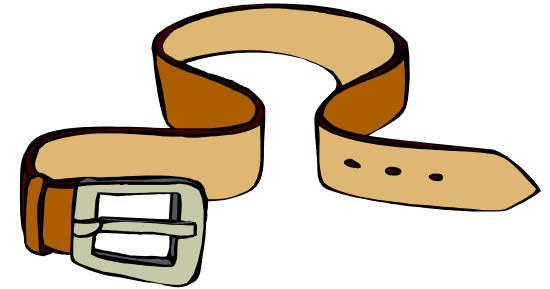

- La cintura
- I guanti
- La cravatta

“Il mio vocabolario”: LA CASA
Far associare ogni parola all’immagine corrispondente.

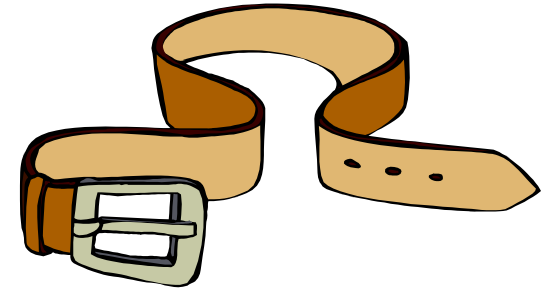

“Il mio vocabolario”: LA CASA
Come si chiama?

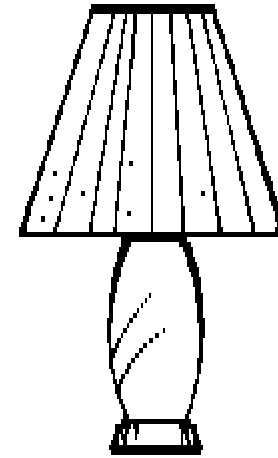
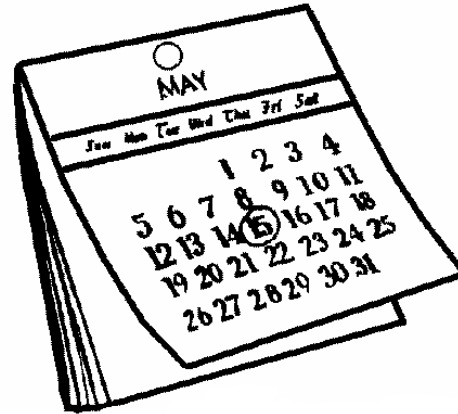

La pianta

Il calendario

La lampada

“Il mio vocabolario”: LA CASA
Far associare ogni parola all’immagine corrispondente.

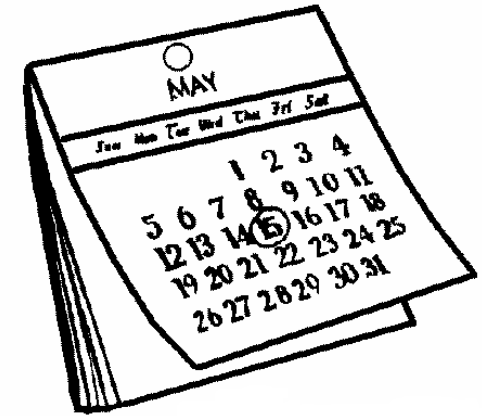
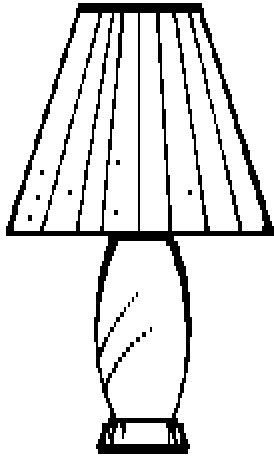

- Il calendario
- La lampada
- La pianta

“Il mio vocabolario”: LA CASA
Far associare ogni parola all’immagine corrispondente.

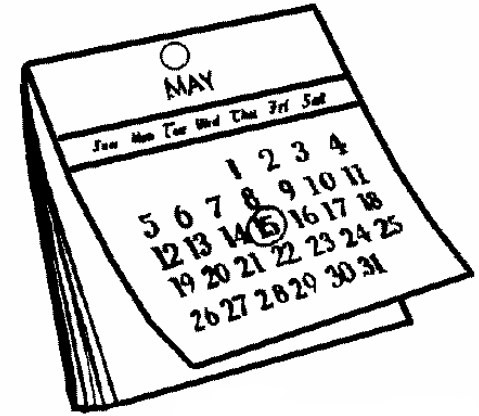
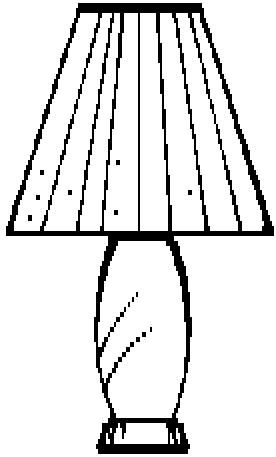

"Il mio vocabolario": LA CASA
Come si chiama?

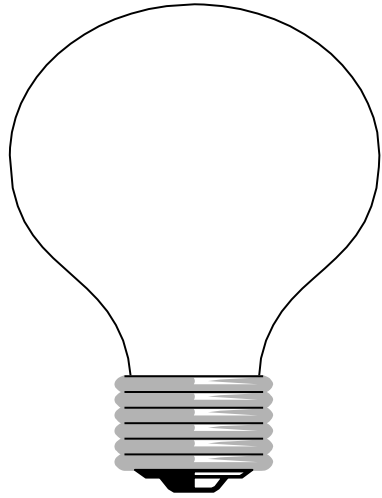

La lampadina

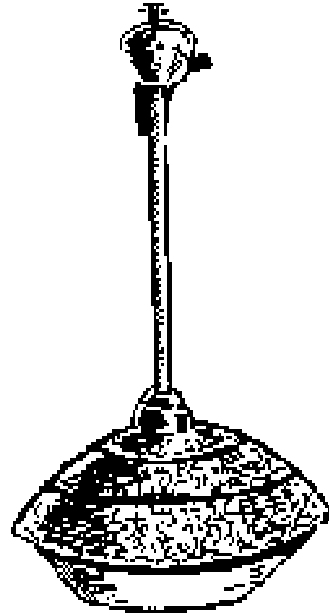

Il lampadario

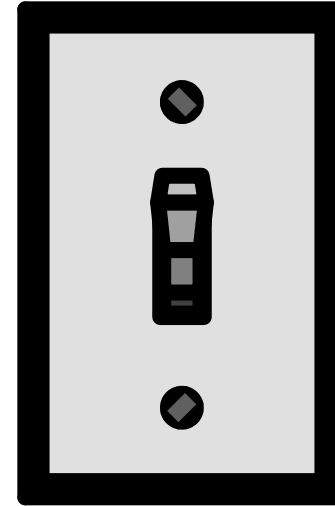

L'interruttore

"Il mio vocabolario": LA CASA
Far associare ogni parola all'immagine corrispondente.

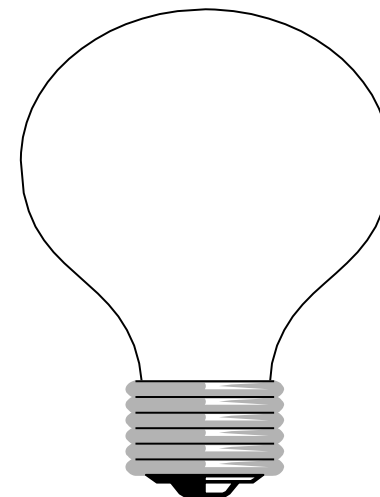
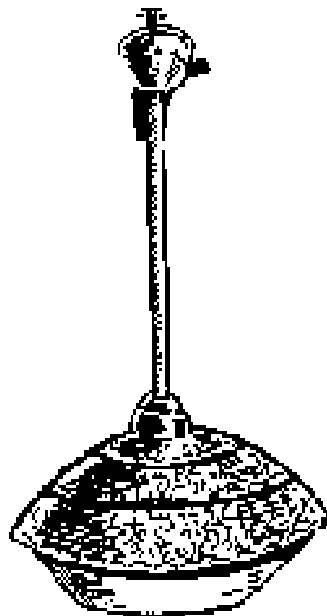
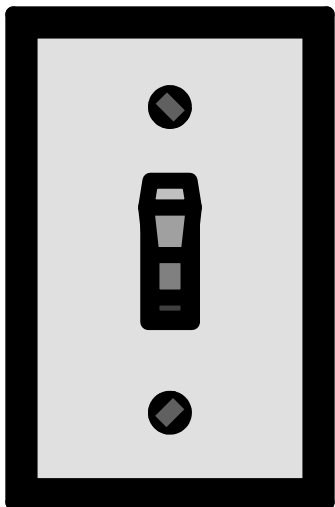

La lampadina

Il lampadario

L'interruttore

"Il mio vocabolario": LA CASA
Far associare ogni parola all'immagine corrispondente.

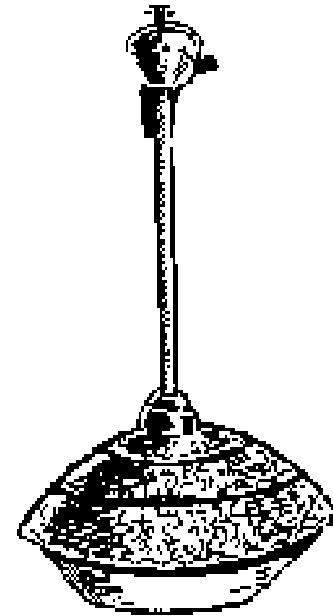
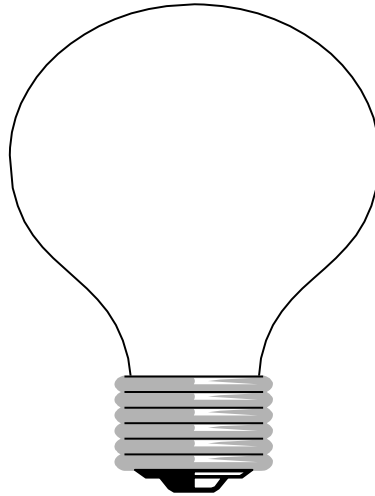
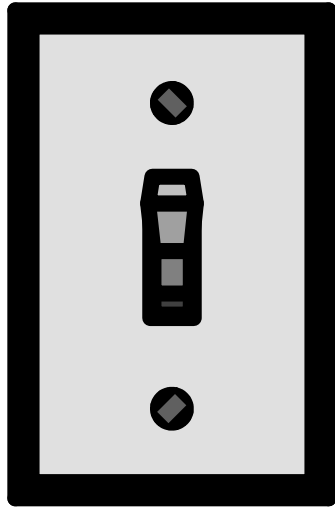

"Il mio vocabolario": LA CASA
Come si chiama?



La pila

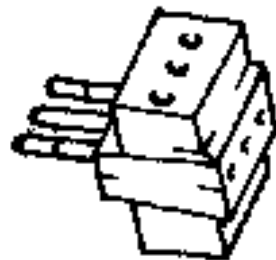

La multi presa elettrica

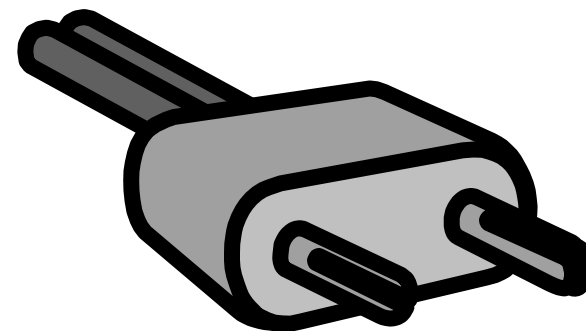

La spina elettrica

“Il mio vocabolario”: LA CASA
Far associare ogni parola all’immagine corrispondente.



La pila

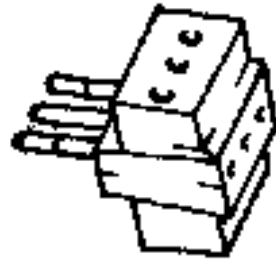

La multi presa elettrica

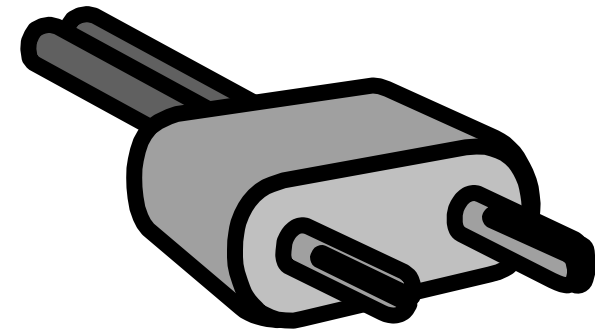

La spina elettrica

“Il mio vocabolario”: LA CASA
Far associare ogni parola all’immagine corrispondente.

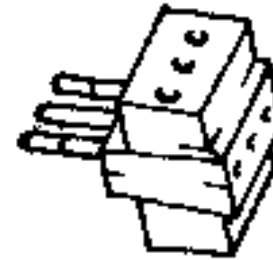
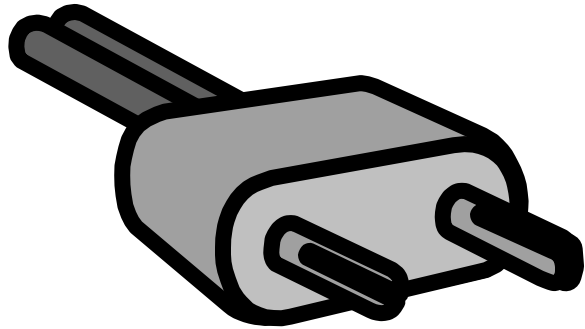

“Il mio vocabolario”: LA CASA
Come si chiama?

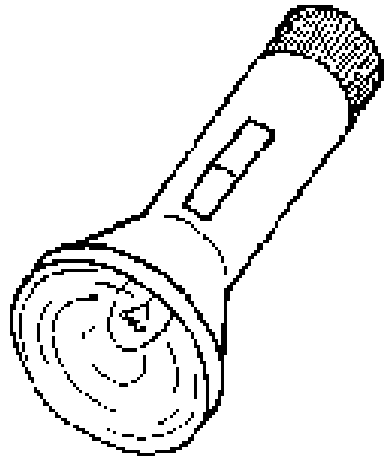

La torcia

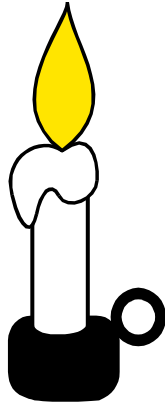

La candela



Il fiammifero

“Il mio vocabolario”: LA CASA
Far associare ogni parola all’immagine corrispondente.

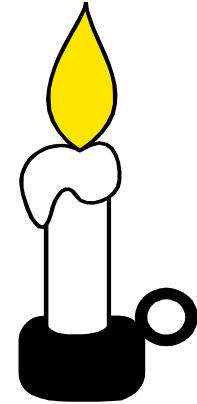
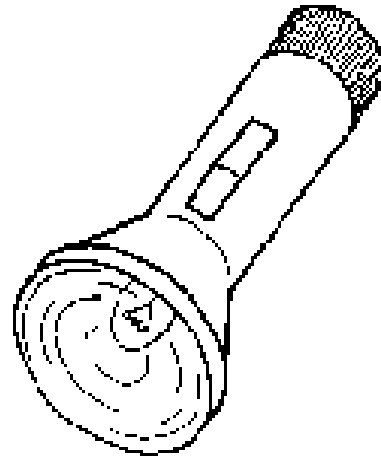

- La candela
- Il fiammifero
- La torcia

“Il mio vocabolario”: LA CASA
Far associare ogni parola all’immagine corrispondente.

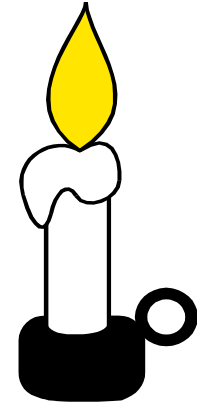
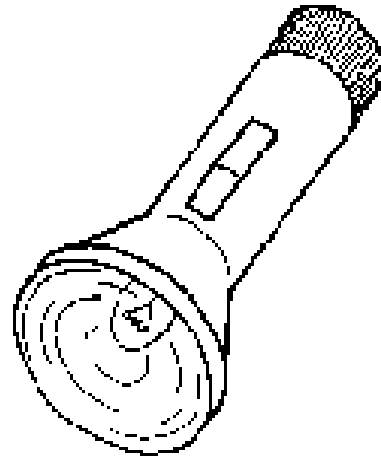

"Il mio vocabolario": LA CASA
Come si chiama?

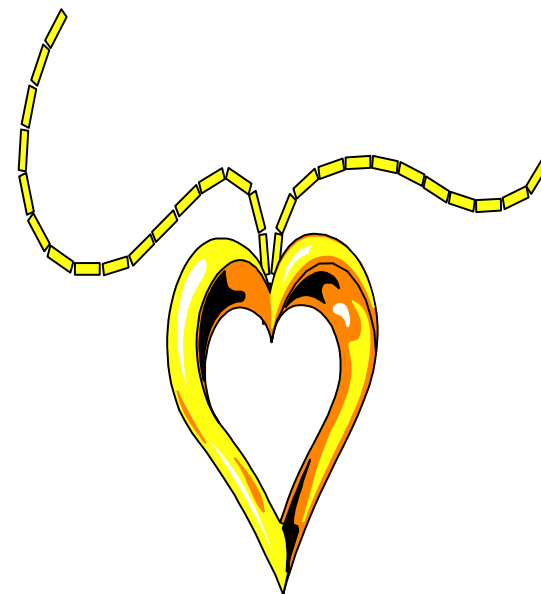
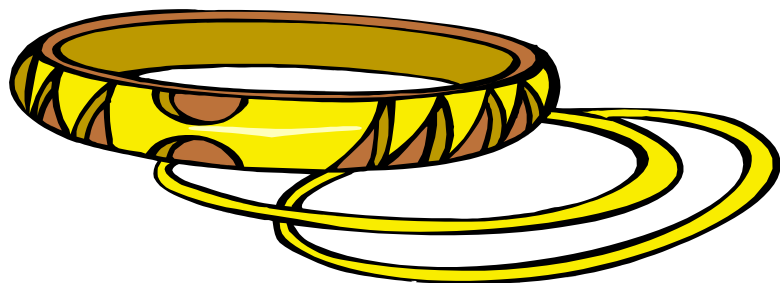
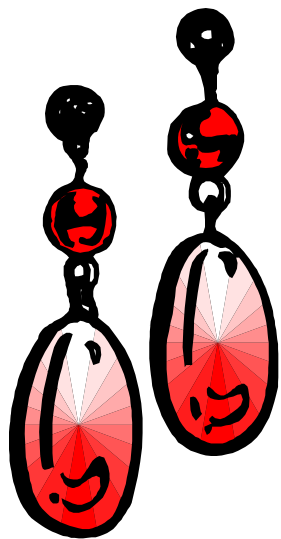

Gli orecchini

I bracciali

La collana

“Il mio vocabolario”: LA CASA
Far associare ogni parola all’immagine corrispondente.



- Gli orecchini
- I bracciali
- La collana

“Il mio vocabolario”: LA CASA
Far associare ogni parola all’immagine corrispondente.

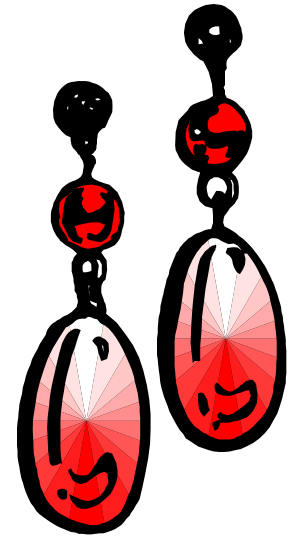
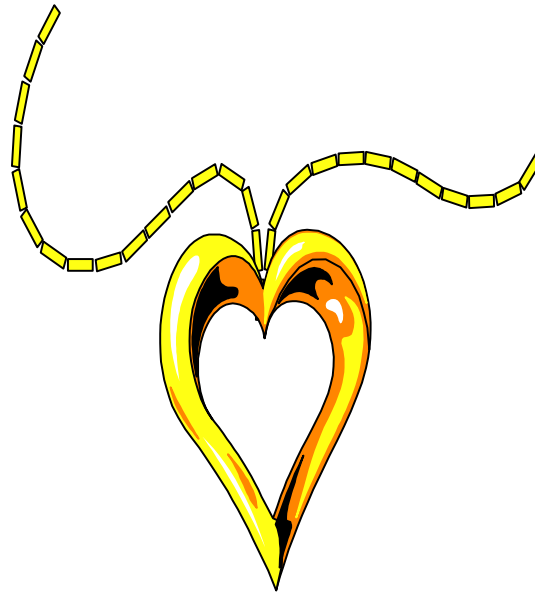
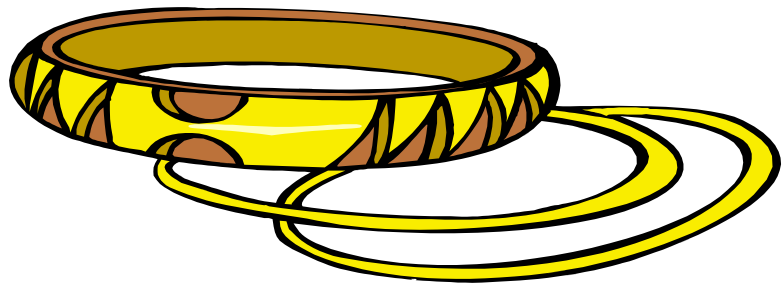

"Il mio vocabolario": LA CASA
Come si chiama?

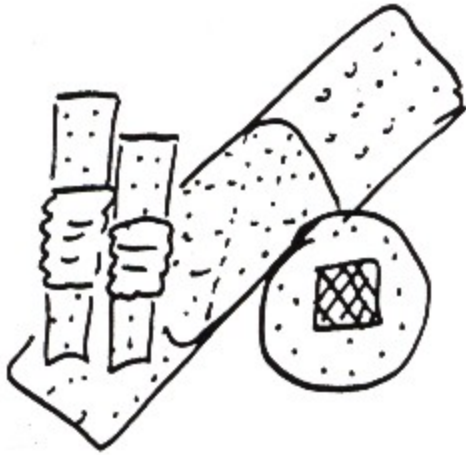

I cerotti

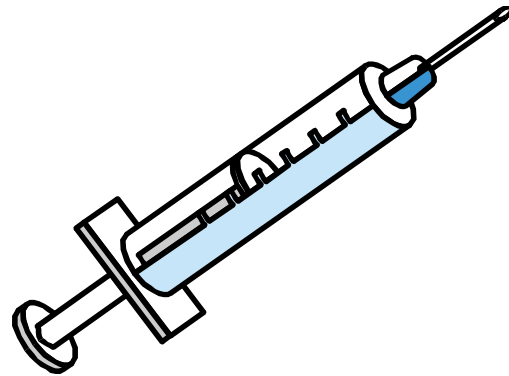

La siringa

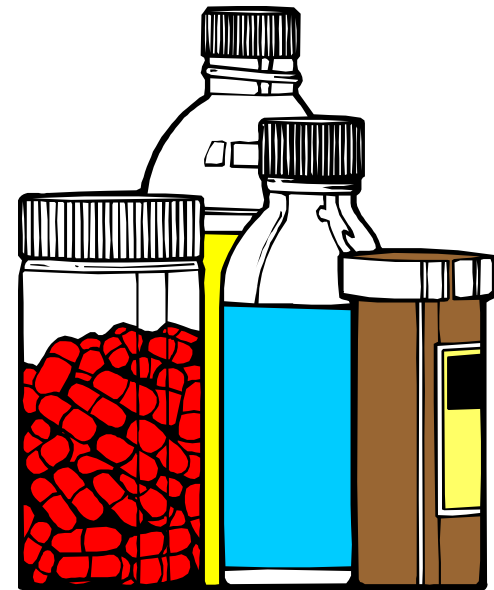

I farmaci

“Il mio vocabolario”: LA CASA
Far associare ogni parola all’immagine corrispondente.

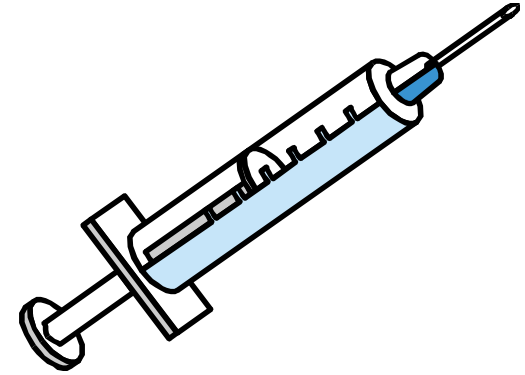
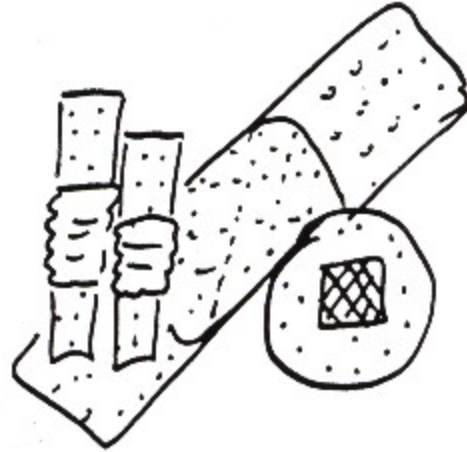
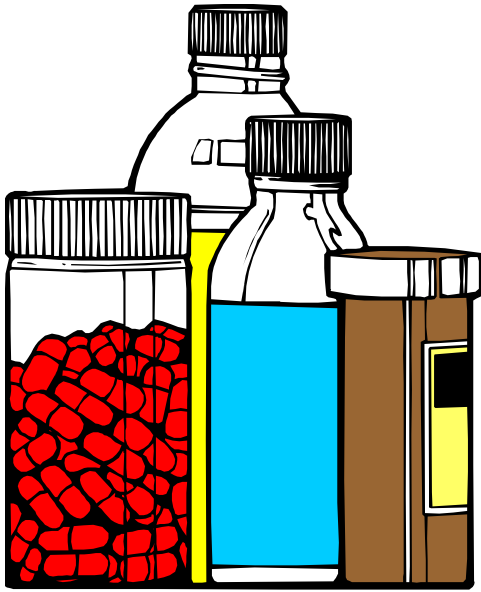

- La siringa
- I farmaci
- I cerotti

“Il mio vocabolario”: LA CASA
Far associare ogni parola all’immagine corrispondente.

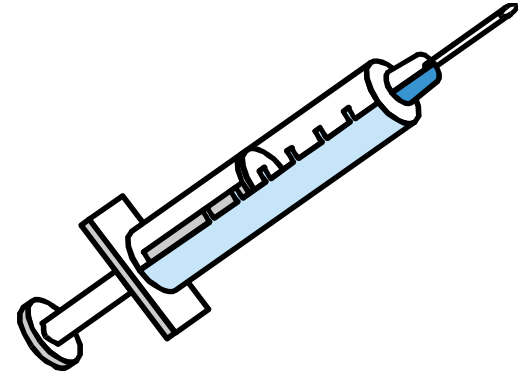
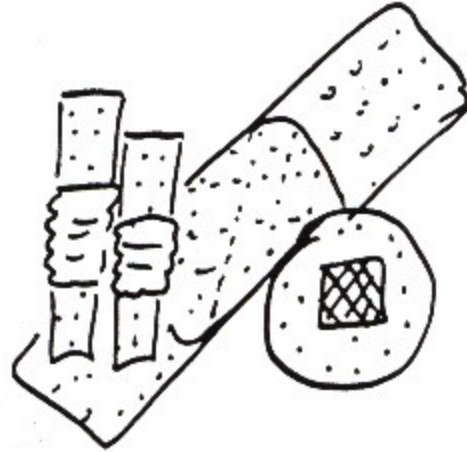
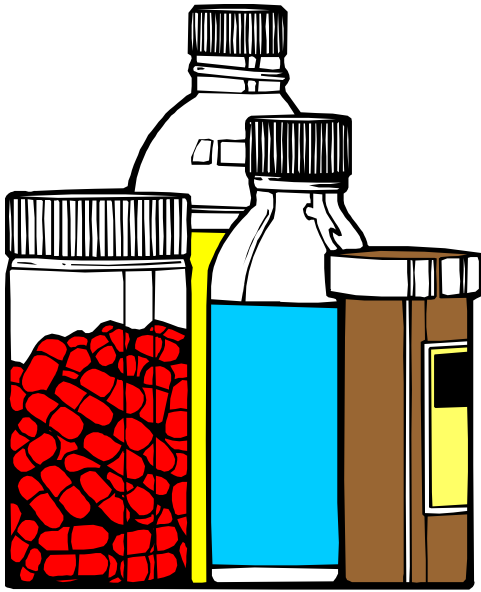

“Il mio vocabolario”: LA CASA
Come si chiama?

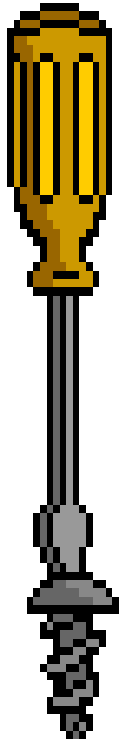

Il cacciavite

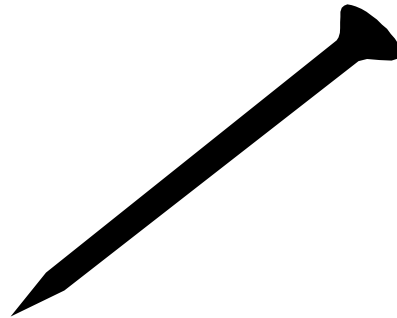

Il chiodo

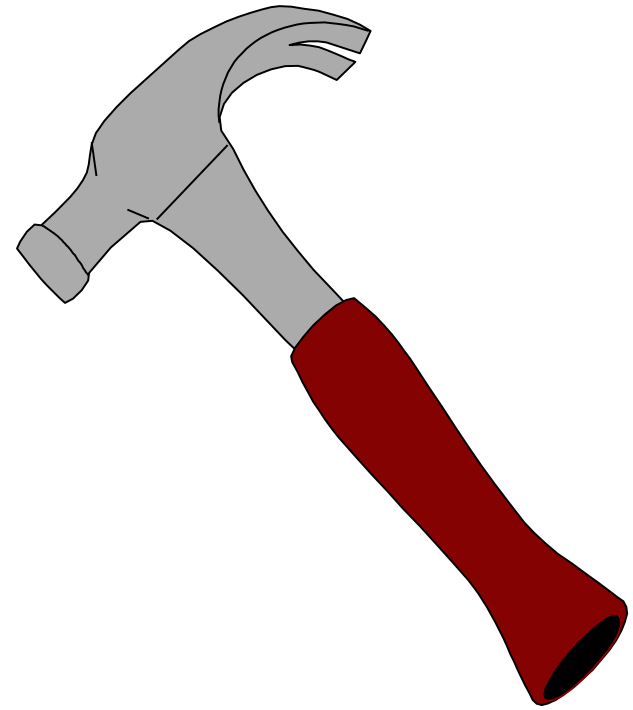

Il martello

“Il mio vocabolario”: LA CASA
Far associare ogni parola all’immagine corrispondente.

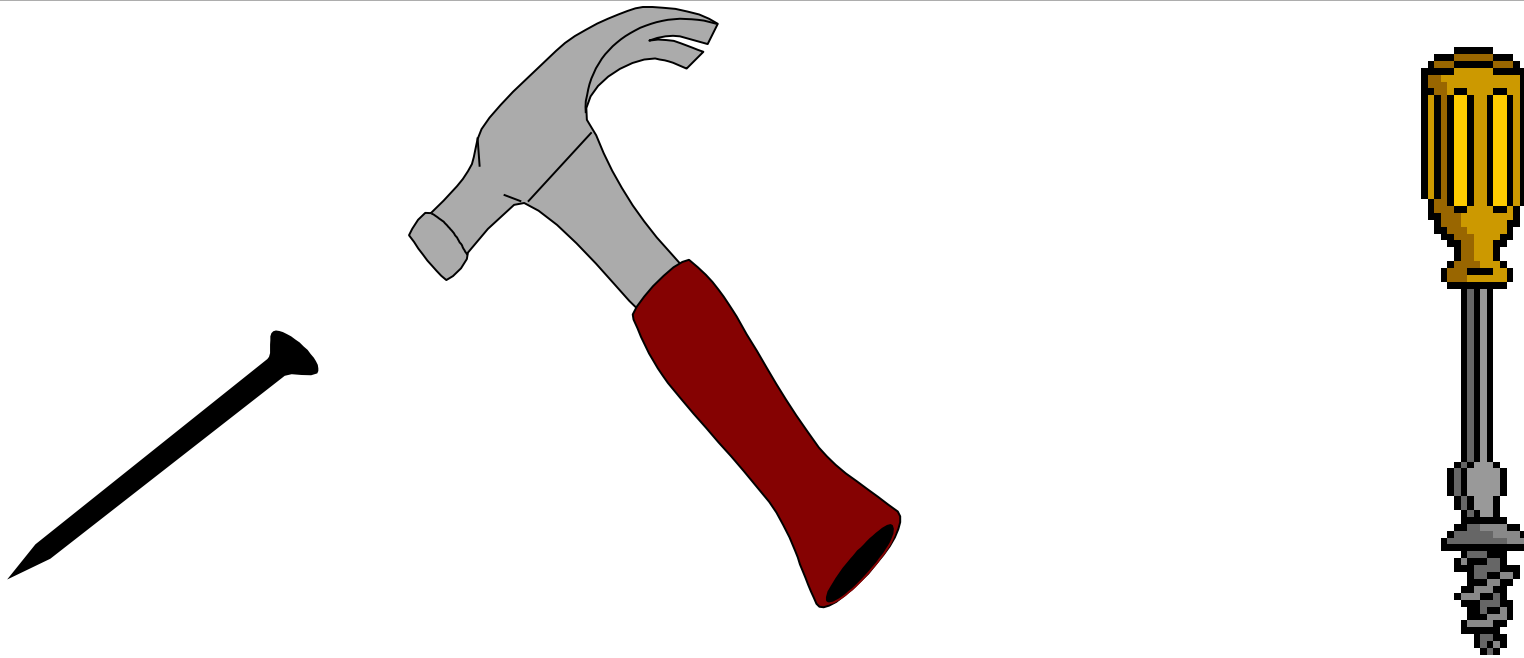

- Il cacciavite
 - Il chiodo
 - Il martello

“Il mio vocabolario”: LA CASA
Far associare ogni parola all’immagine corrispondente.

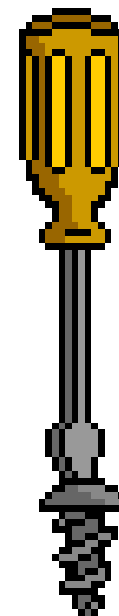
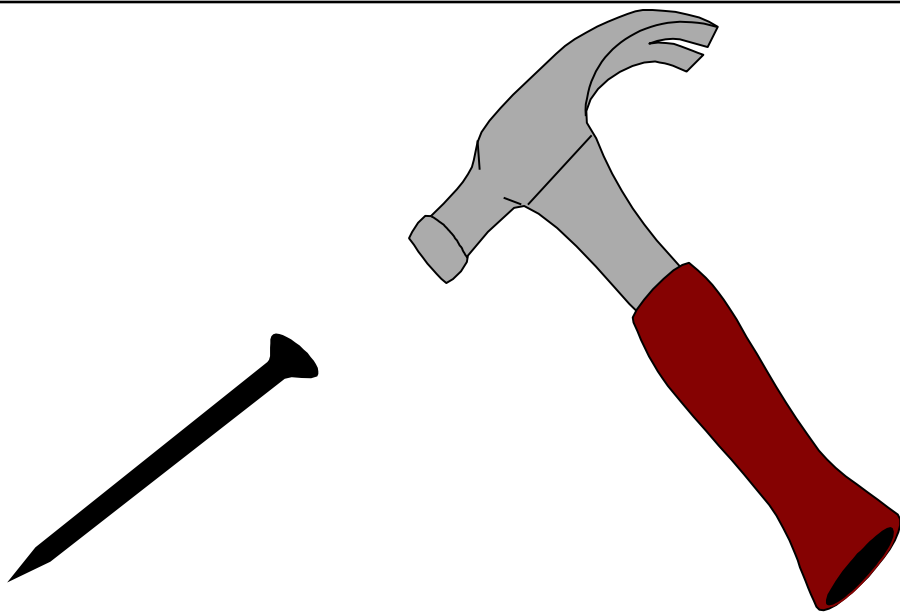

“Il mio vocabolario”: LA CASA
Come si chiama?



La valigia



Lo zaino

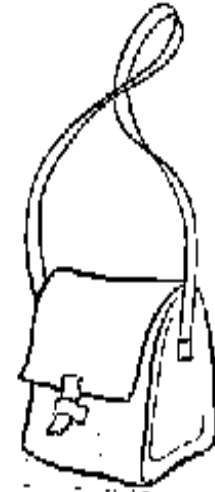

La borsa

“Il mio vocabolario”: LA CASA
Far associare ogni parola all’immagine corrispondente.

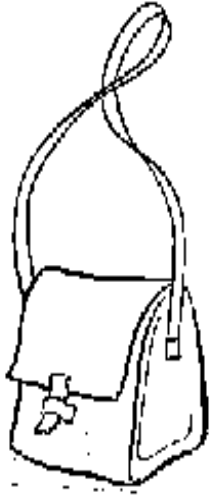

- Lo zaino
- La borsa
- La valigia

“Il mio vocabolario”: LA CASA
Far associare ogni parola all’immagine corrispondente.

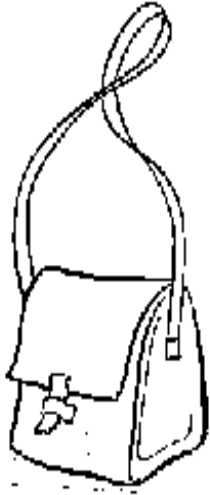

“Il mio vocabolario”: LA CASA
Come si chiama?

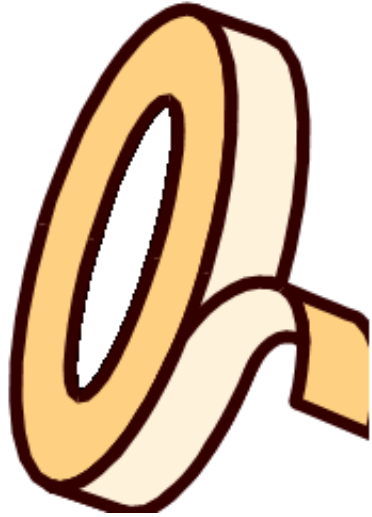

Il nastro adesivo

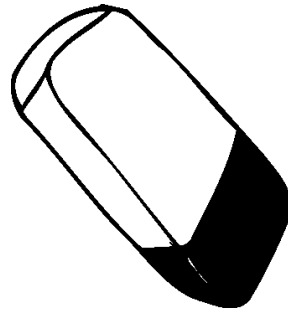

La gomma



La colla

“Il mio vocabolario”: LA CASA
Far associare ogni parola all’immagine corrispondente.

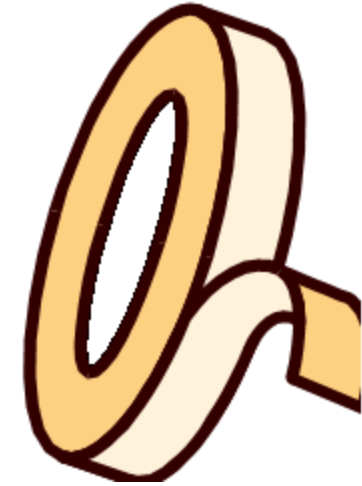
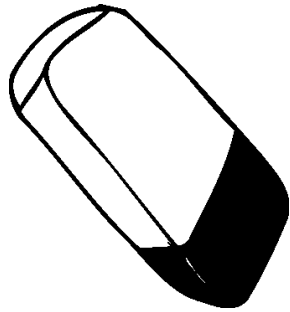

- La colla
- Il nastro adesivo
- La gomma

“Il mio vocabolario”: LA CASA
Far associare ogni parola all’immagine corrispondente.

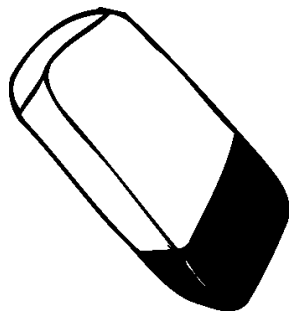

“Il mio vocabolario”: LA CASA
Come si chiama?

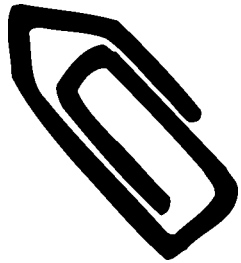

La graffetta

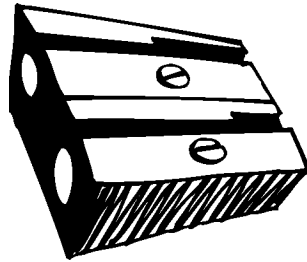

Il temperamatite

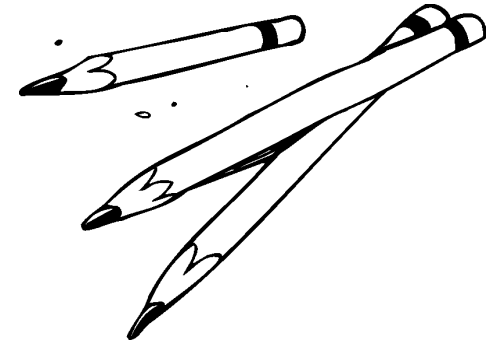

Le matite

“Il mio vocabolario”: LA CASA
Far associare ogni parola all’immagine corrispondente.

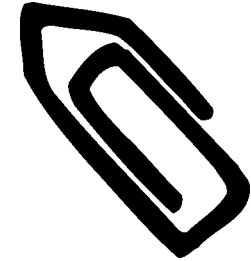
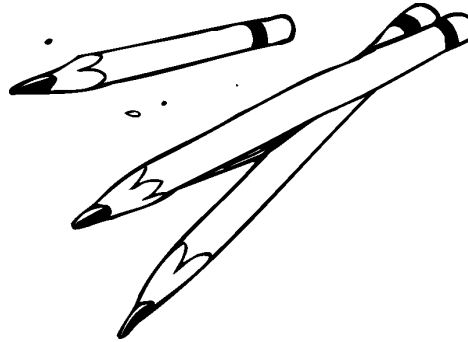
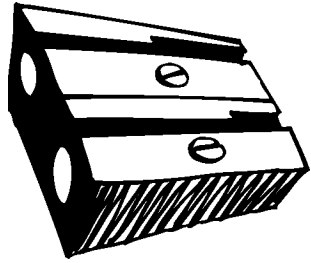

- Le matite
 - La graffetta
 - Il temperamatite

“Il mio vocabolario”: LA CASA
Far associare ogni parola all’immagine corrispondente.

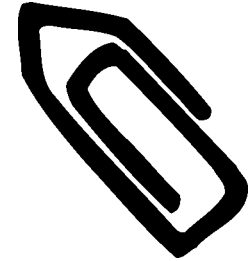
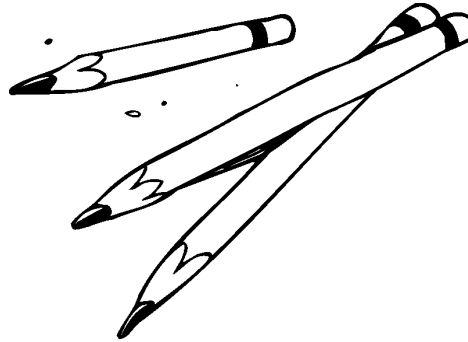
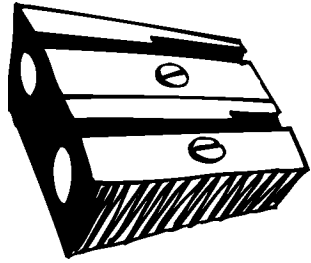

“Il mio vocabolario”: LA CASA
Come si chiama?



Gli occhiali

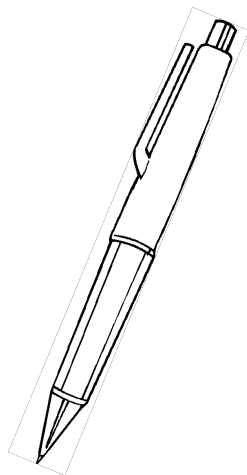

La penna

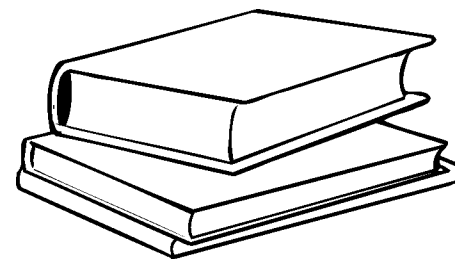

I libri

“Il mio vocabolario”: LA CASA
Far associare ogni parola all’immagine corrispondente.

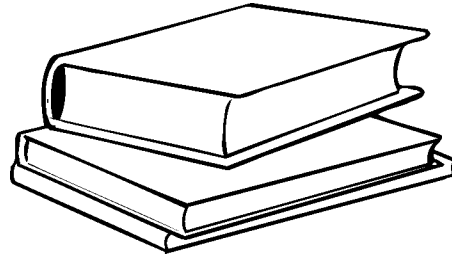
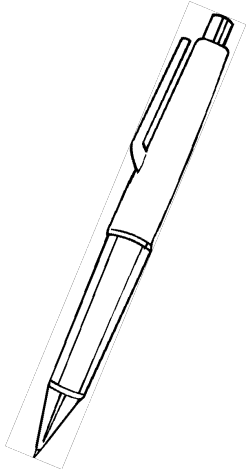

- Gli occhiali
 - La penna
 - I libri

“Il mio vocabolario”: LA CASA
Far associare ogni parola all’immagine corrispondente.

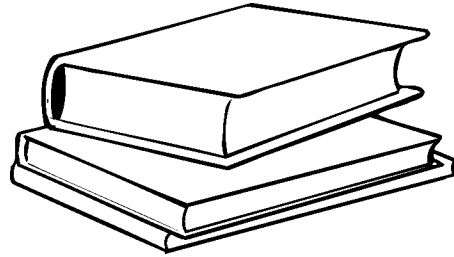
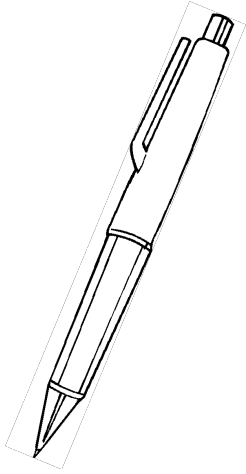

“Il mio vocabolario”: LA CASA
Come si chiama?

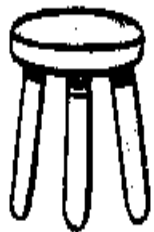

Lo sgabello

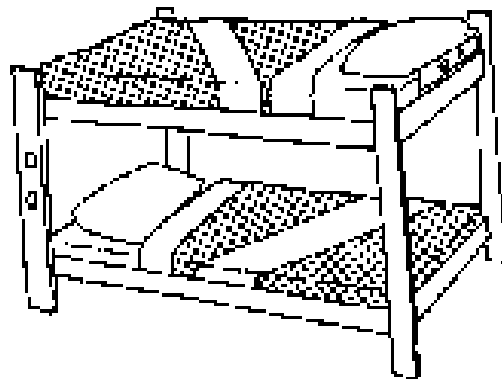

Il letto a castello

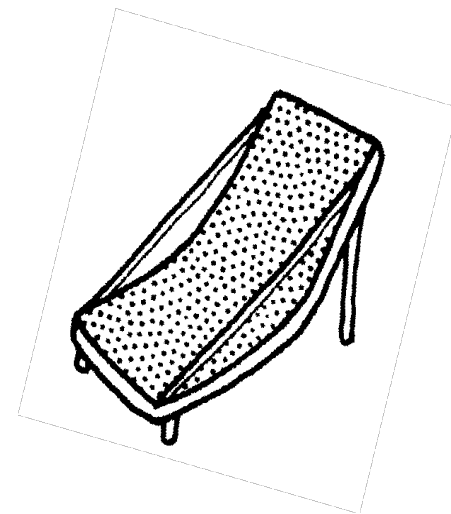

La sdraio

“Il mio vocabolario”: LA CASA
Far associare ogni parola all’immagine corrispondente.

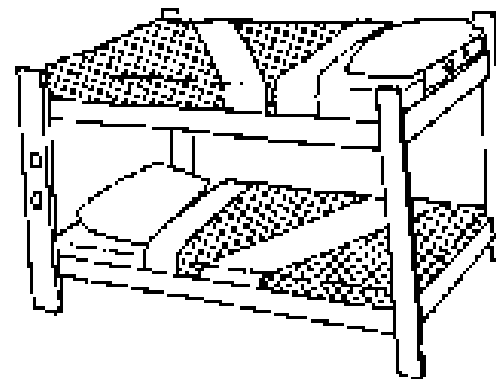
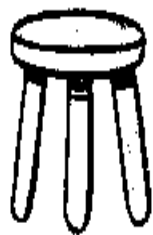
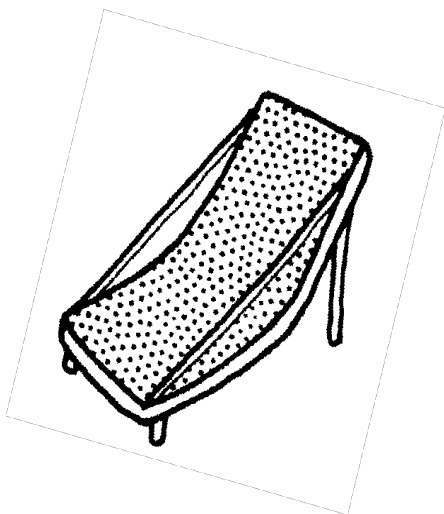

- Il letto a castello
- Lo sgabello
- La sdraio

“Il mio vocabolario”: LA CASA
Far associare ogni parola all’immagine corrispondente.

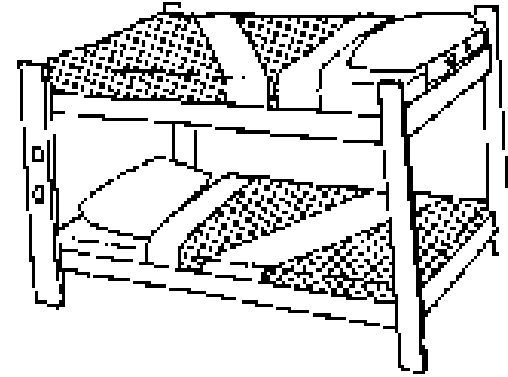
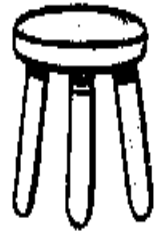
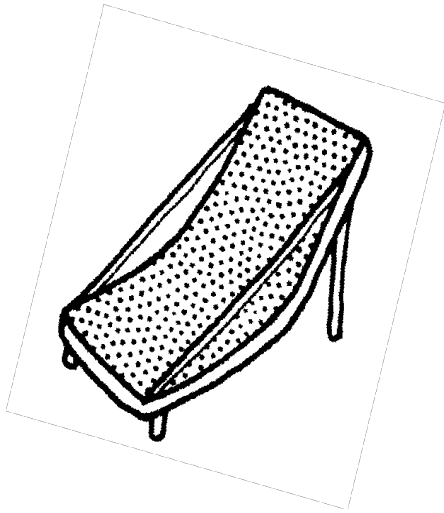

“Il mio vocabolario”: LA CASA
Come si chiama?



Il telefono

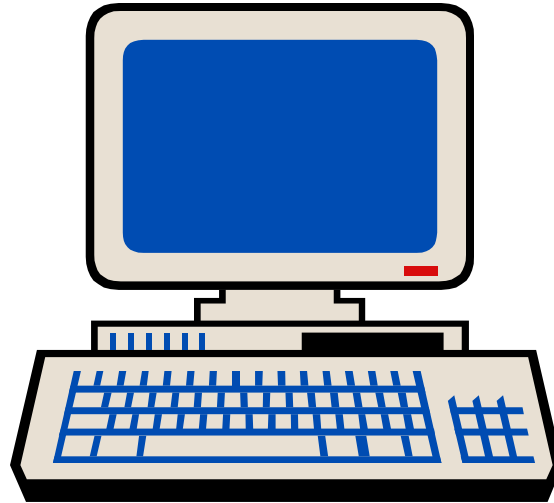

Il computer

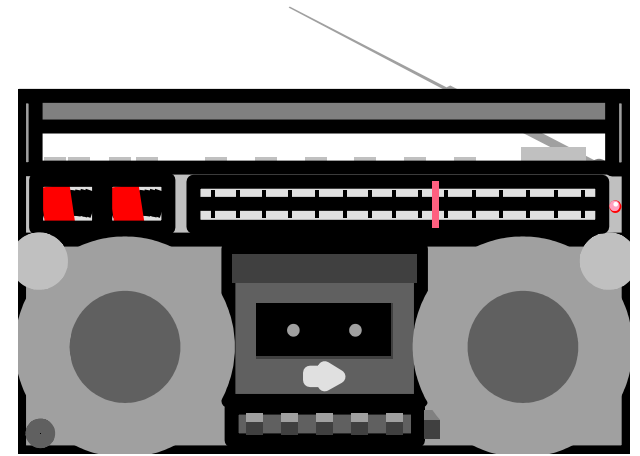

La radio

“Il mio vocabolario”: LA CASA
Far associare ogni parola all’immagine corrispondente.

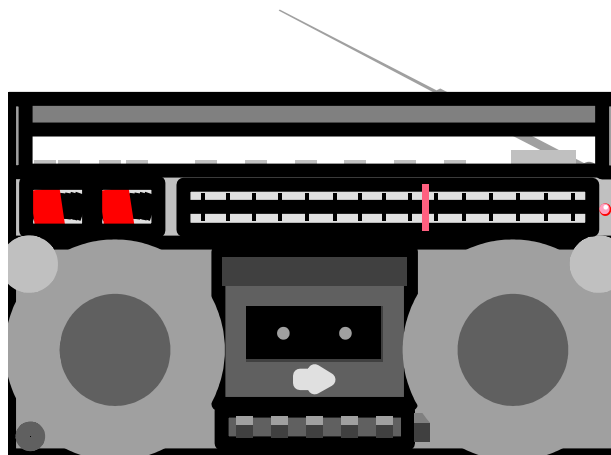
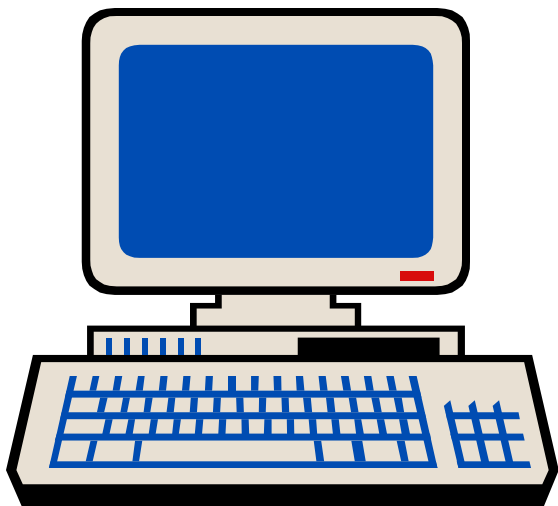

- La radio
- Il telefono
- Il computer

“Il mio vocabolario”: LA CASA
Far associare ogni parola all’immagine corrispondente.

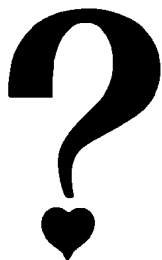
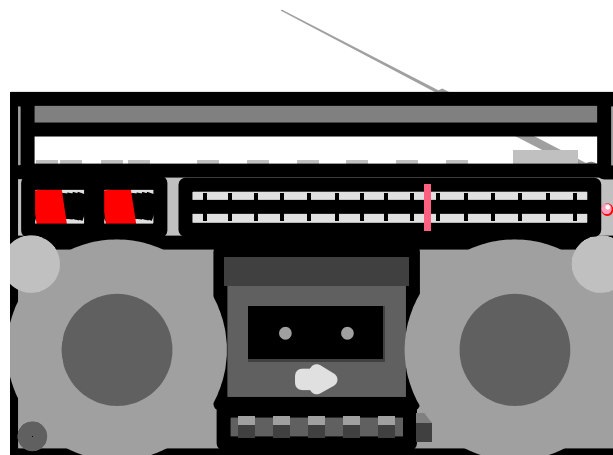
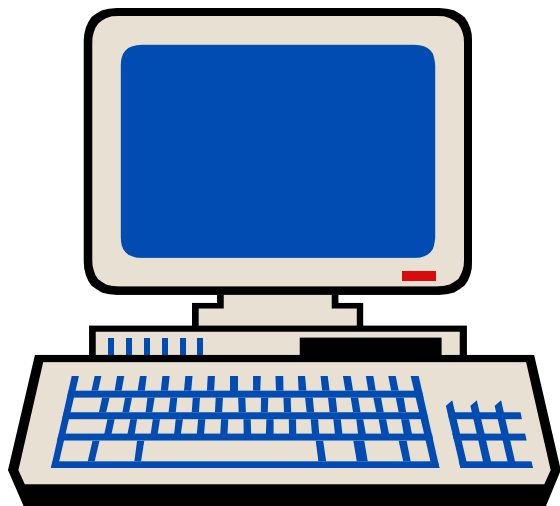

"Il mio vocabolario": LA CASA
Come si chiama?

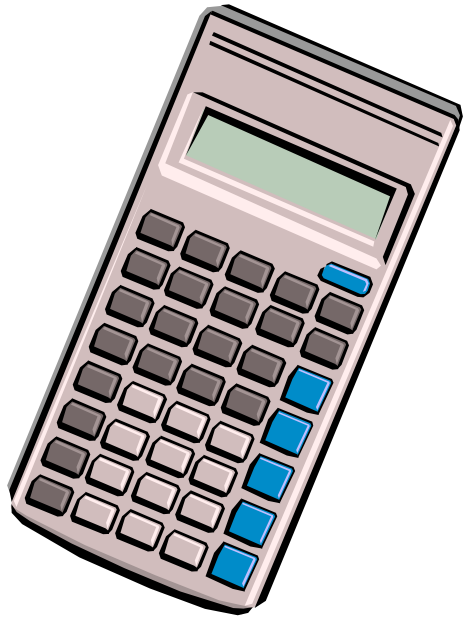

La calcolatrice

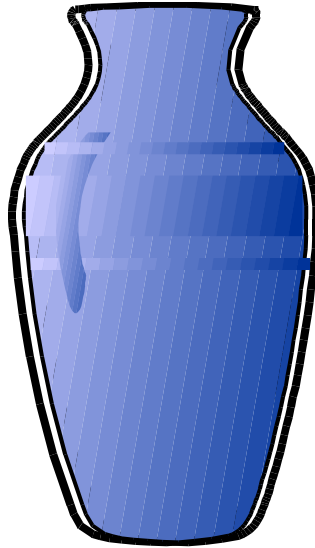

Il vaso

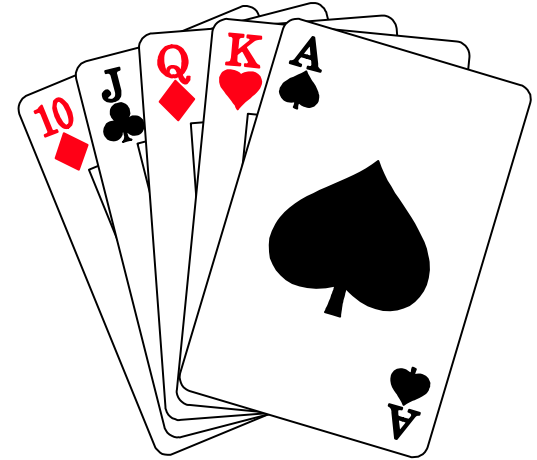

Le carte da gioco

“Il mio vocabolario”: LA CASA
Far associare ogni parola all’immagine corrispondente.

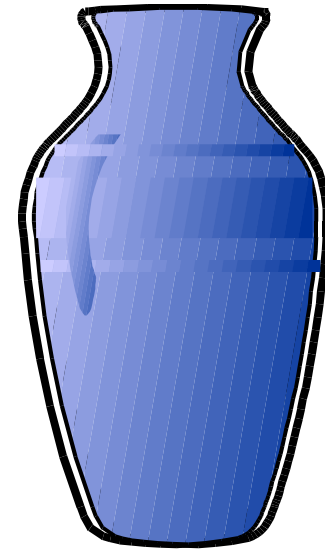
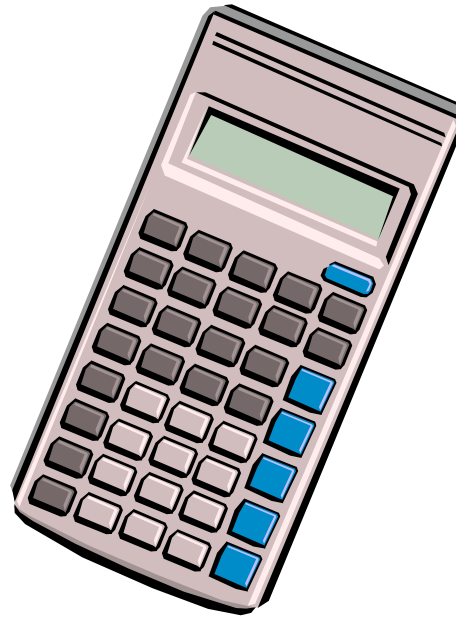
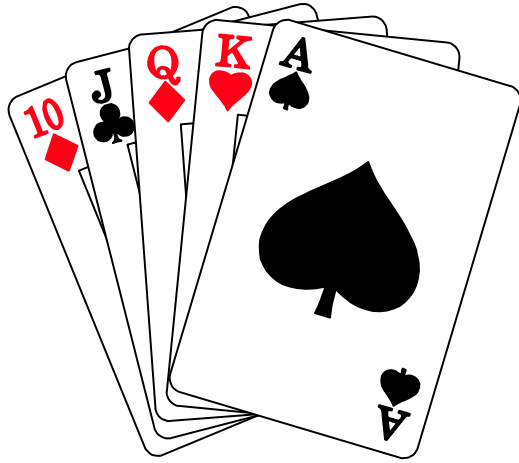

- La calcolatrice
 - Il vaso
- Le carte da gioco

“Il mio vocabolario”: LA CASA
Far associare ogni parola all’immagine corrispondente.

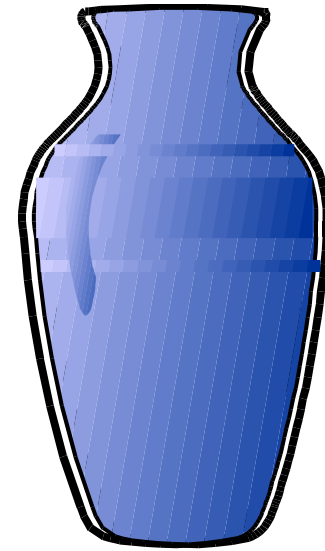
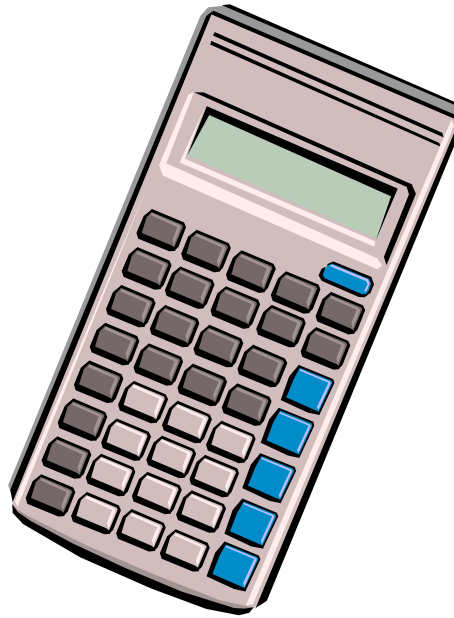
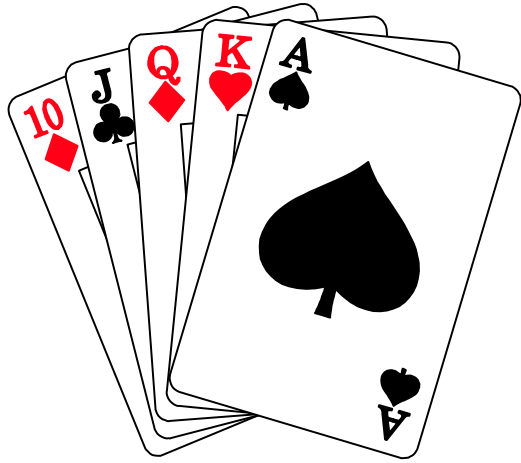

“Il mio vocabolario”: LA CASA
Come si chiama?

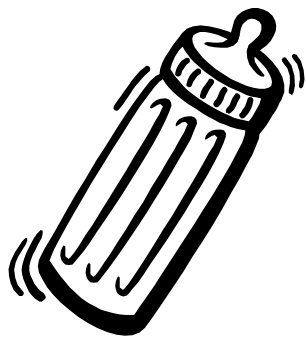

Il biberon



La bambola

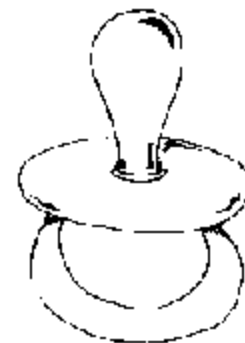

Il ciuccio

“Il mio vocabolario”: LA CASA
Far associare ogni parola all’immagine corrispondente.

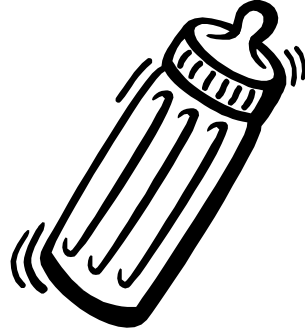
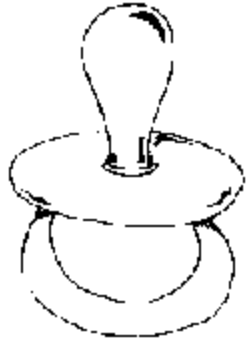

- La bambola
 - Il ciuccio
 - Il biberon

“Il mio vocabolario”: LA CASA
Far associare ogni parola all’immagine corrispondente.

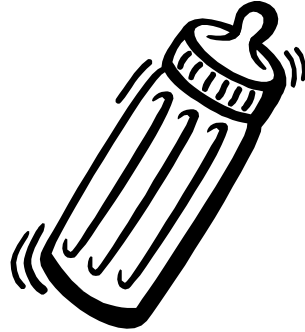
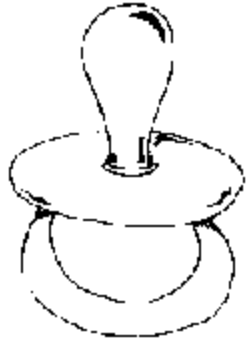

"Il mio vocabolario": LA CASA
Come si chiama?



L'orsetto



Il sonaglino



La giostra

“Il mio vocabolario”: LA CASA
Far associare ogni parola all'immagine corrispondente.



- Il sonaglino
 - La giostra
 - L'orsetto

"Il mio vocabolario": LA CASA
Far associare ogni parola all'immagine corrispondente.



“Il mio vocabolario”: LA CASA
Come si chiama?

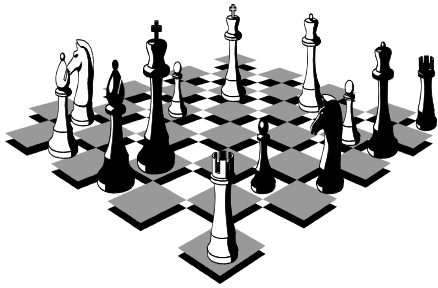

Gli scacchi

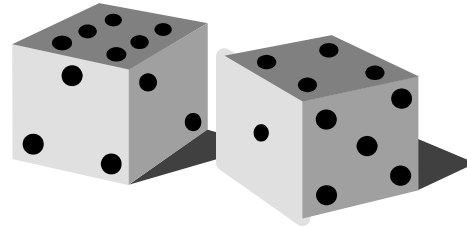

I dadi

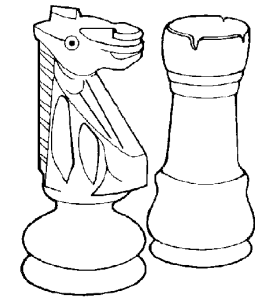

Le pedine

“Il mio vocabolario”: LA CASA
Far associare ogni parola all’immagine corrispondente.

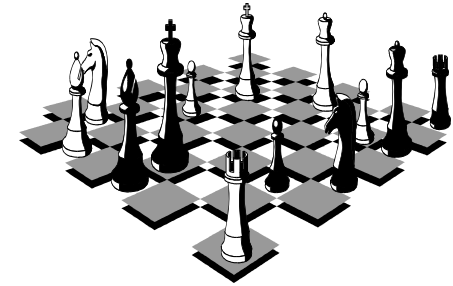
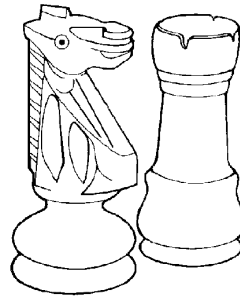
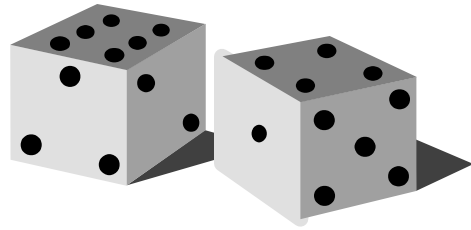

- Le pedine
- Gli scacchi
- I dadi

“Il mio vocabolario”: LA CASA
Far associare ogni parola all’immagine corrispondente.

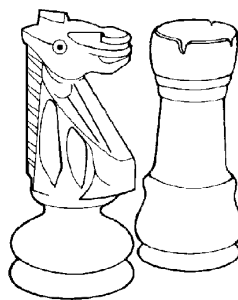
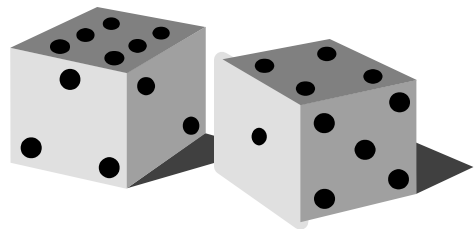

“Il mio vocabolario”: LA CASA
Come si chiama?

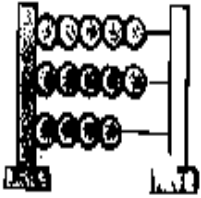

L'abaco



L'aquilone



I palloncini

“Il mio vocabolario”: LA CASA
Far associare ogni parola all'immagine corrispondente.

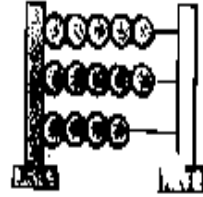

- L'abaco
- I palloncini
- L'aquilone

"Il mio vocabolario": LA CASA
Far associare ogni parola all'immagine corrispondente.

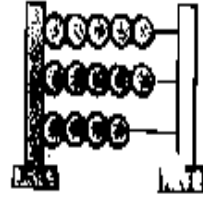

"Il mio vocabolario": LA CASA
Come si chiama?

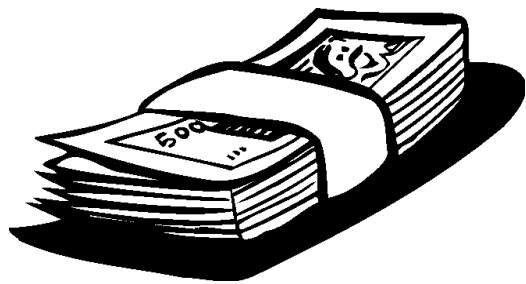

Le banconote

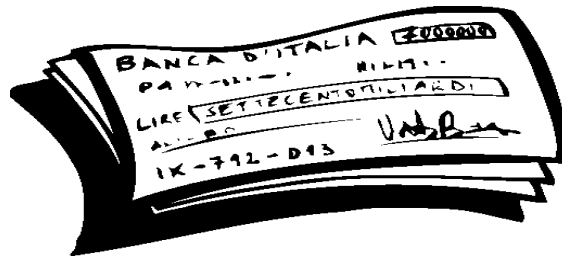

Gli assegni

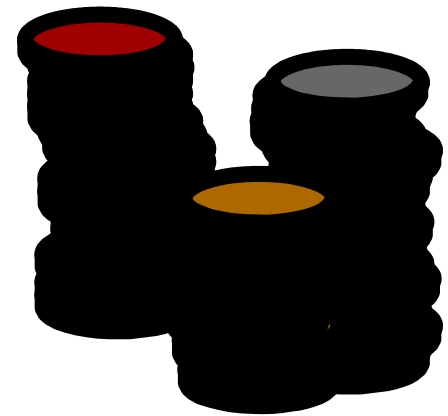

Le monete

“Il mio vocabolario”: LA CASA
Far associare ogni parola all’immagine corrispondente.

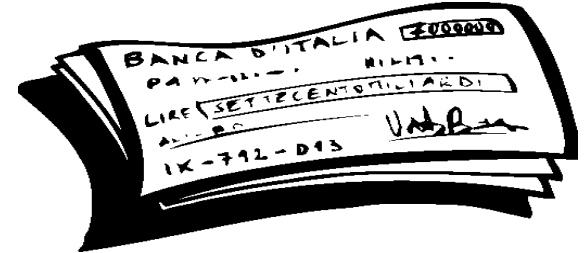
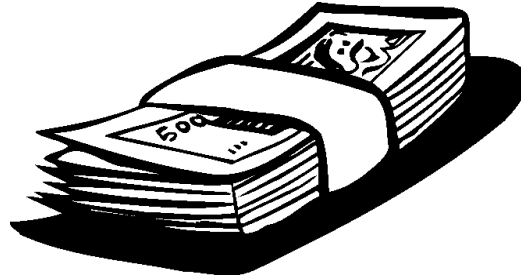
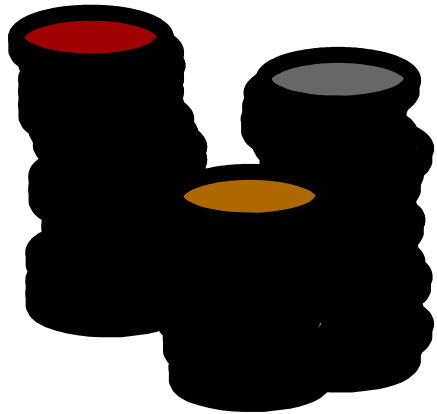

- Le banconote
 - Gli assegni
 - Le monete

“Il mio vocabolario”: LA CASA
Far associare ogni parola all’immagine corrispondente.

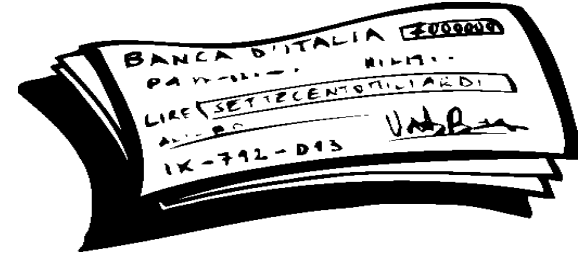
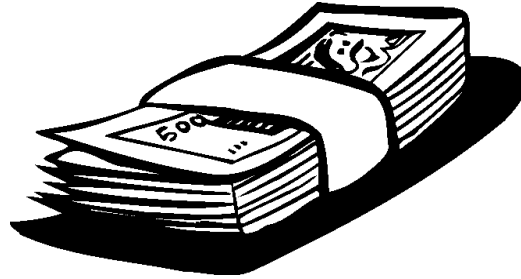
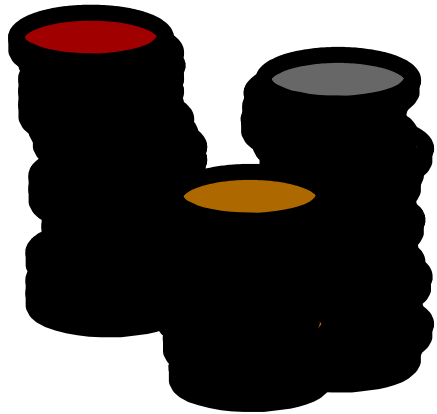

- Le banconote
 - Gli assegni
 - Le monete

“Il mio vocabolario”: LA CASA
Far associare ogni parola all’immagine corrispondente.

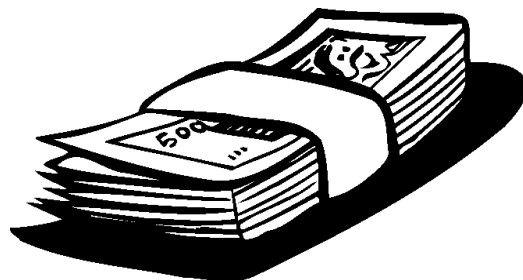
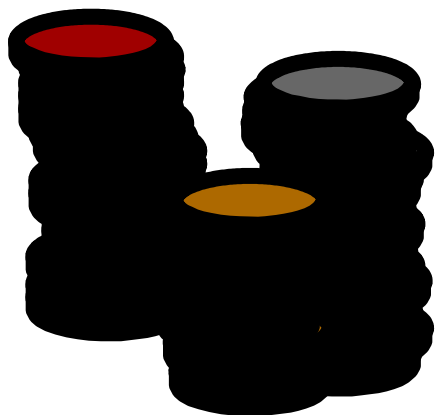

"Il mio vocabolario": LA CASA
Come si chiama?

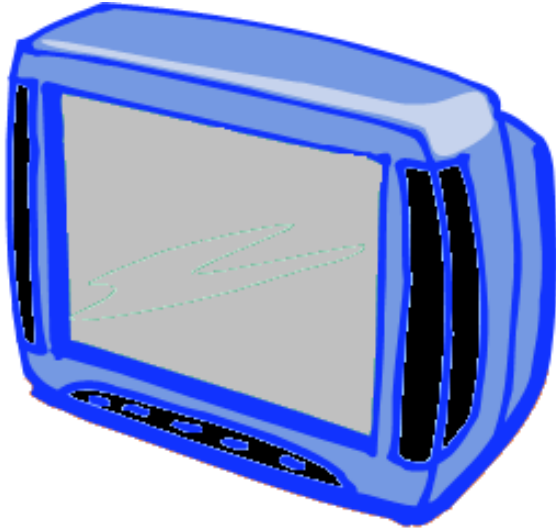

La televisione



La macchina
da scrivere



La macchina
fotografica

“Il mio vocabolario”: LA CASA
Far associare ogni parola all’immagine corrispondente.

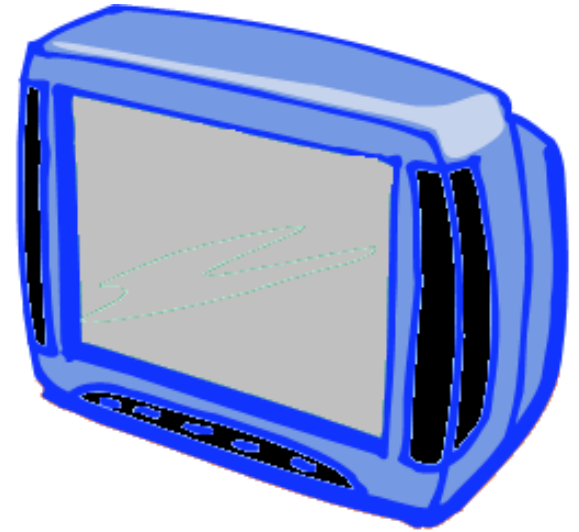
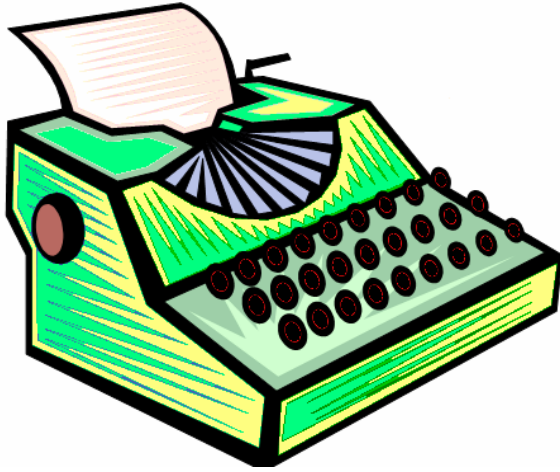

- La televisione
 - La macchina da scrivere
 - La macchina fotografica

“Il mio vocabolario”: LA CASA
Far associare ogni parola all’immagine corrispondente.

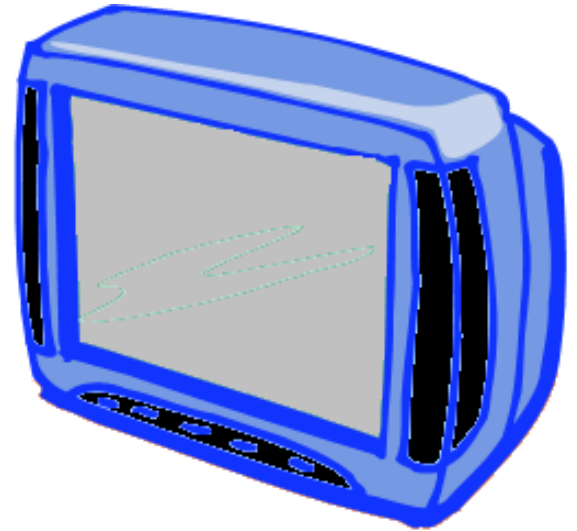
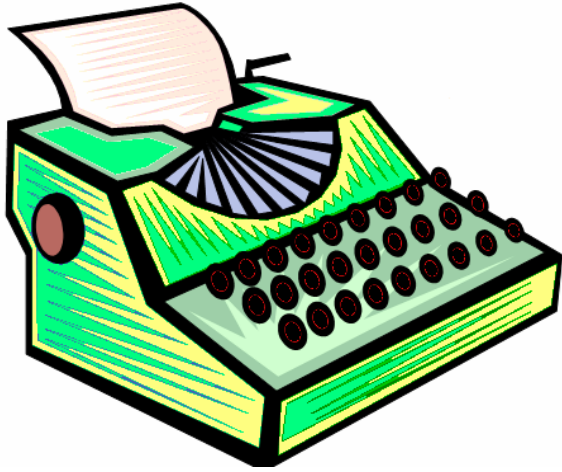

“Il mio vocabolario”: LA CASA
Come si chiama?



La sveglia

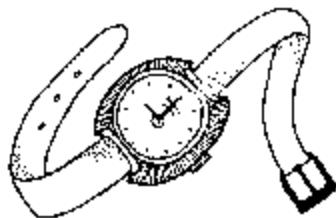

L'orologio da polso

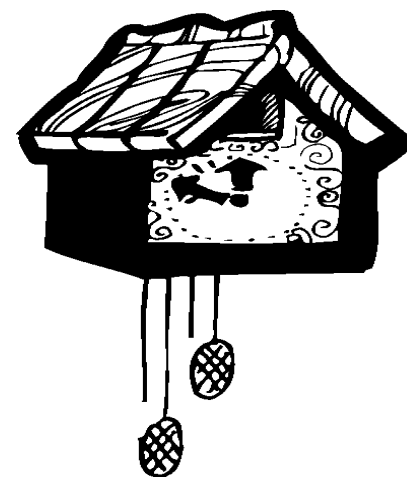

L'orologio
a pendolo

"Il mio vocabolario": LA CASA
Far associare ogni parola all'immagine corrispondente.

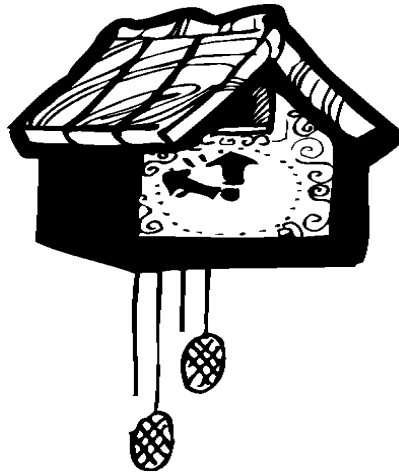
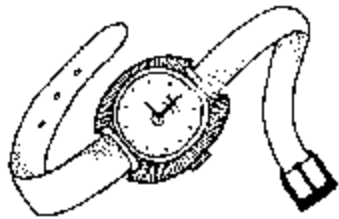

- L'orologio a pendolo
 - La sveglia
- L'orologio a pendolo

"Il mio vocabolario": LA CASA
Far associare ogni parola all'immagine corrispondente.

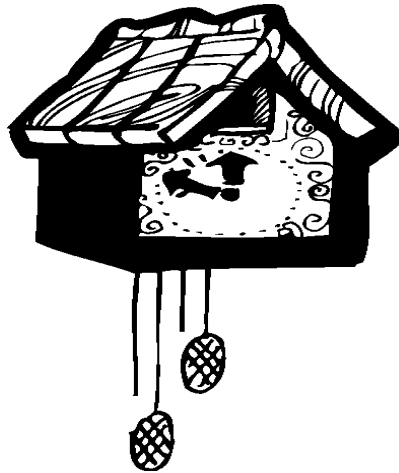
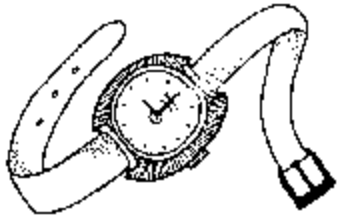

“Il mio vocabolario”: LA CASA
Come si chiama?

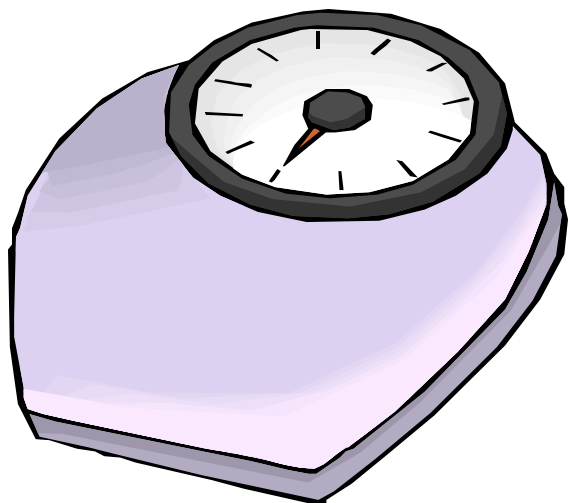

La bilancia
pesa persone



La bilancia
pesa alimenti



Il metro

“Il mio vocabolario”: LA CASA
Far associare ogni parola all’immagine corrispondente.

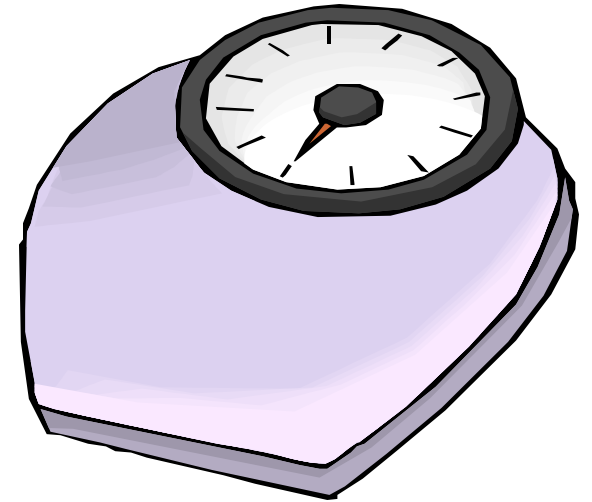

- Il metro
 - La bilancia pesa alimenti
 - La bilancia pesa persone

“Il mio vocabolario”: LA CASA
Far associare ogni parola all’immagine corrispondente.

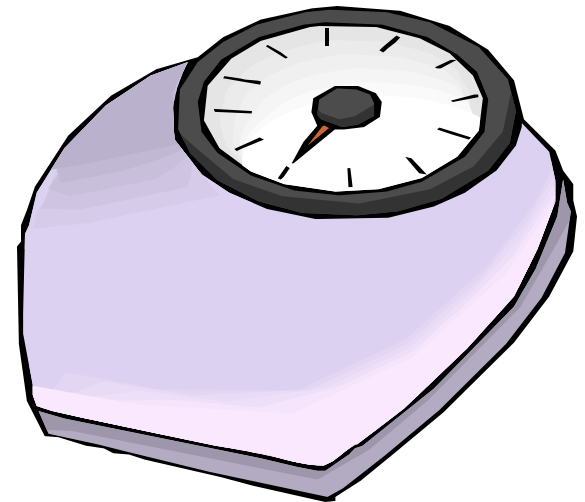

“Il mio vocabolario”: LA CASA
Come si chiama?

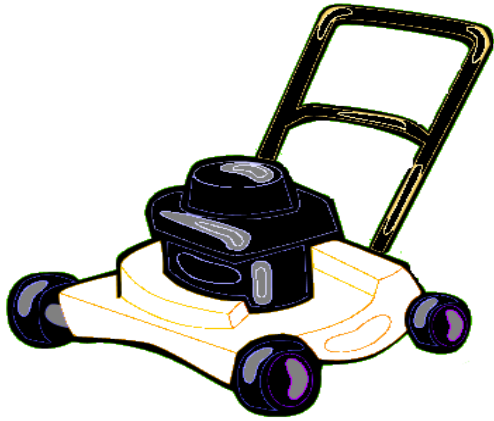

Il tosa erba

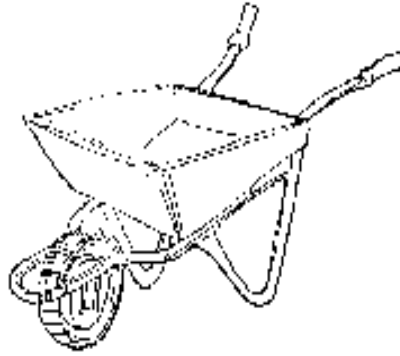

La carriola



Il rastrello

“Il mio vocabolario”: LA CASA
Far associare ogni parola all’immagine corrispondente.

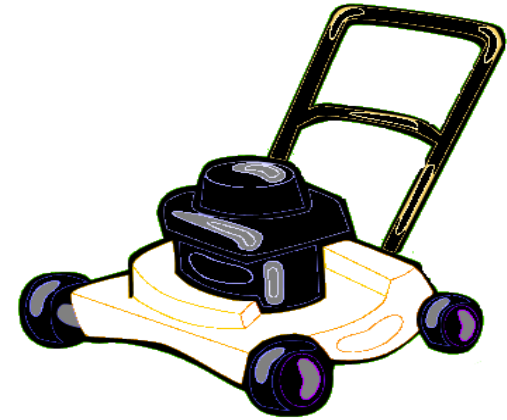
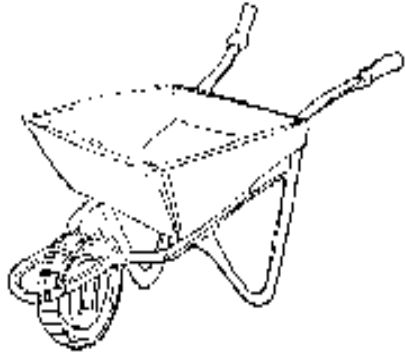

- Il rastrello
- Il tosa erba
- La carriola

“Il mio vocabolario”: LA CASA
Far associare ogni parola all’immagine corrispondente.

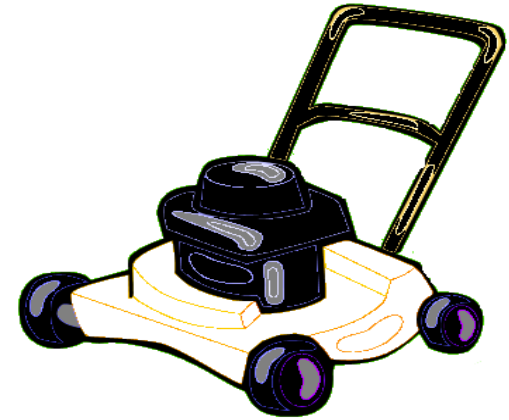
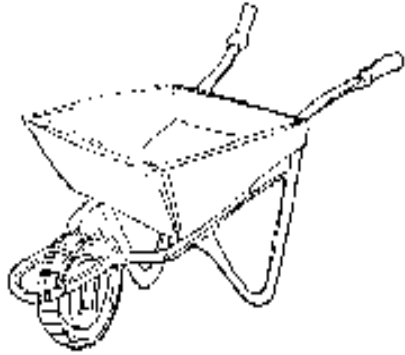

“Il mio vocabolario”: LA CASA
Come si chiama?



Attrezzi da
giardinaggio

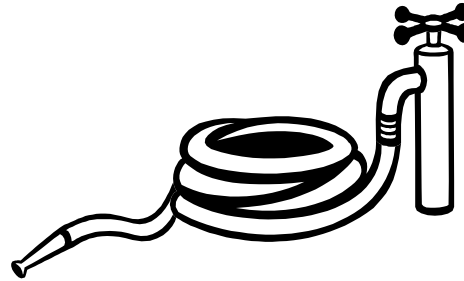

La pompa
per l'acqua

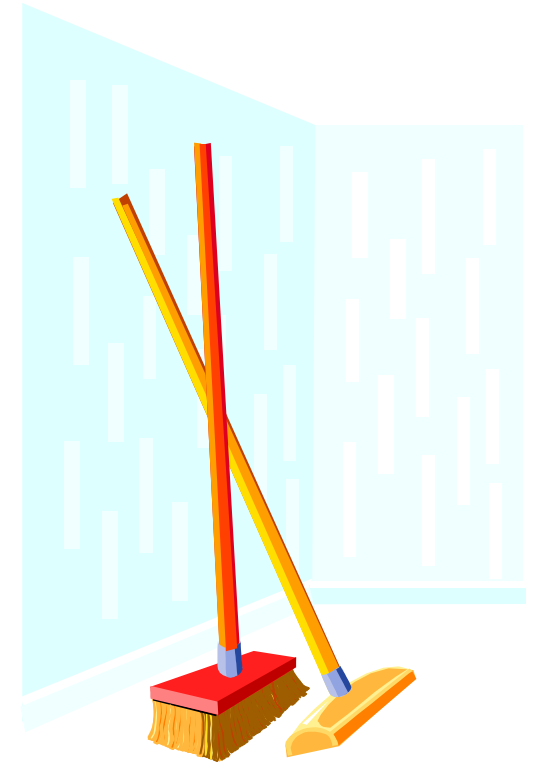

Le scope

"Il mio vocabolario": LA CASA
Far associare ogni parola all'immagine corrispondente.

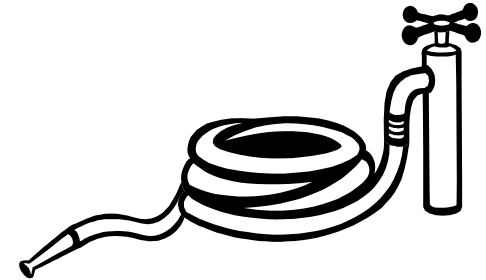
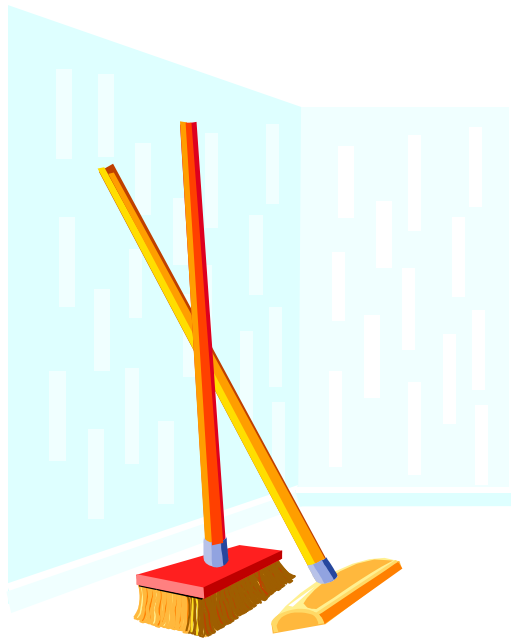

- La pompa dell'acqua
 - Le scope
 - Gli attrezzi da giardino

"Il mio vocabolario": LA CASA
Far associare ogni parola all'immagine corrispondente.

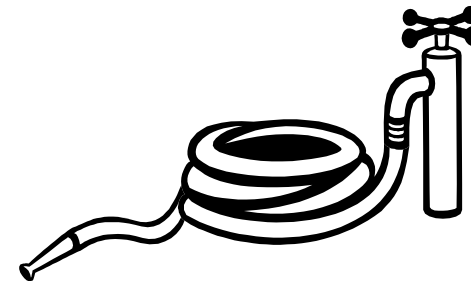
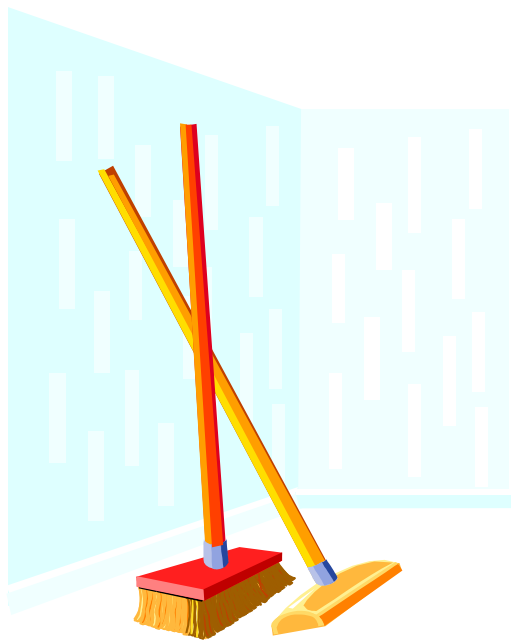

“Il mio vocabolario”: LA CASA
Come si chiama?

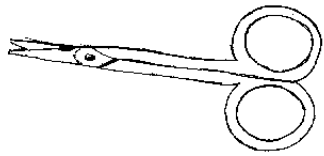

Le forbicine



Il profumo



Il pettine

“Il mio vocabolario”: LA CASA
Far associare ogni parola all’immagine corrispondente.

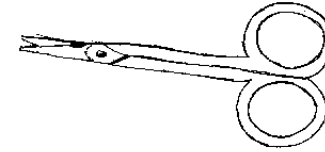
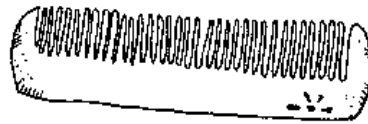

- Le forbicine
- Il profumo
- Il pettine.

“Il mio vocabolario”: LA CASA
Far associare ogni parola all’immagine corrispondente.

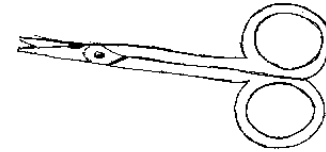

“Il mio vocabolario”: LA CASA
Come si chiama?

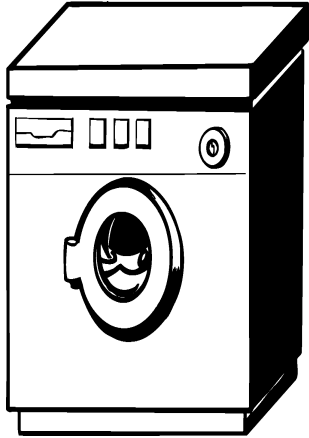

La lavatrice

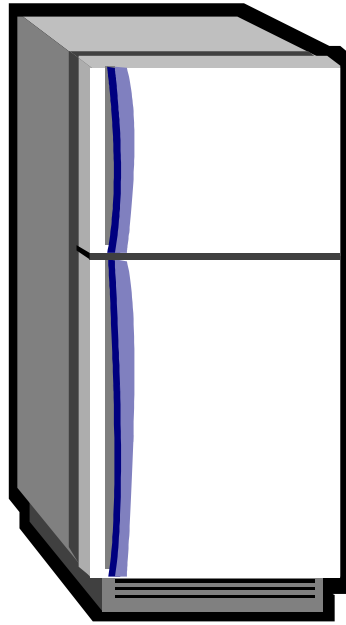

Il frigo

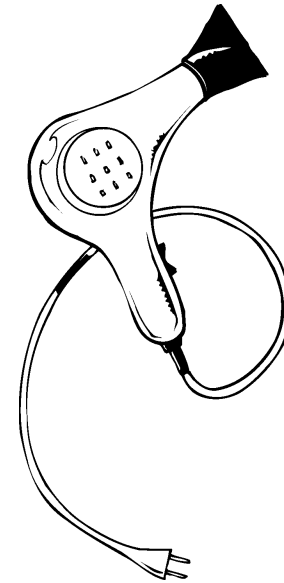

Il phon

“Il mio vocabolario”: LA CASA
Far associare ogni parola all’immagine corrispondente.

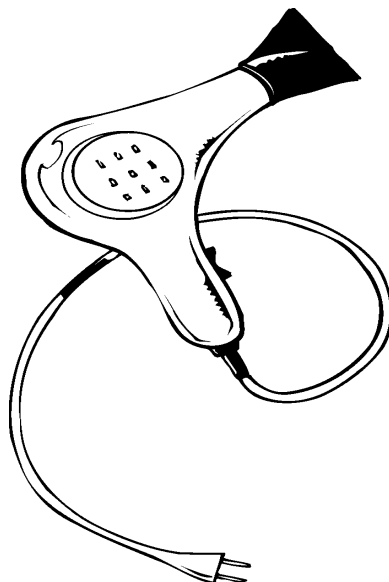
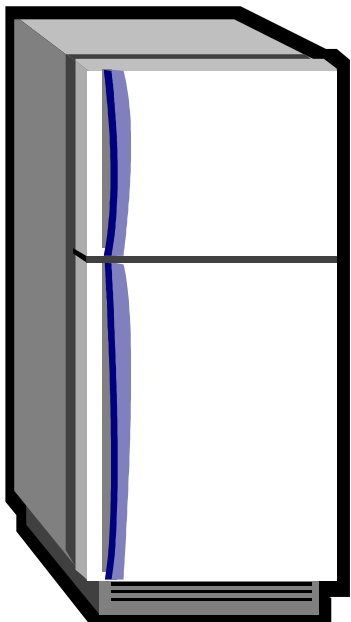

- La lavatrice
- Il frigo
- Il phon.

“Il mio vocabolario”: LA CASA
Far associare ogni parola all’immagine corrispondente.

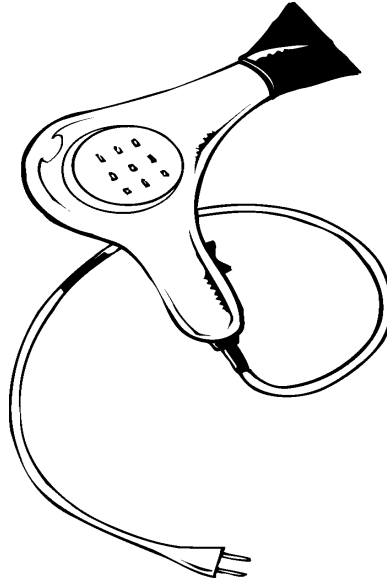
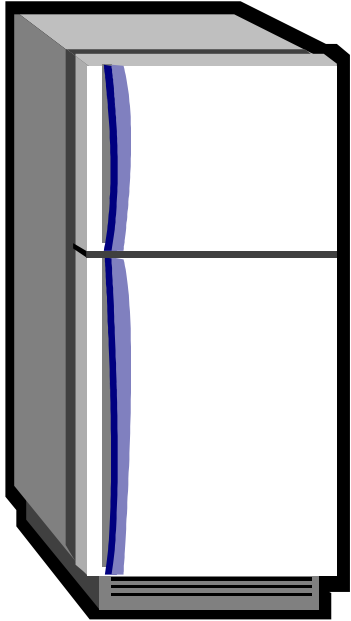

“Il mio vocabolario”: LA CASA
Come si chiama?

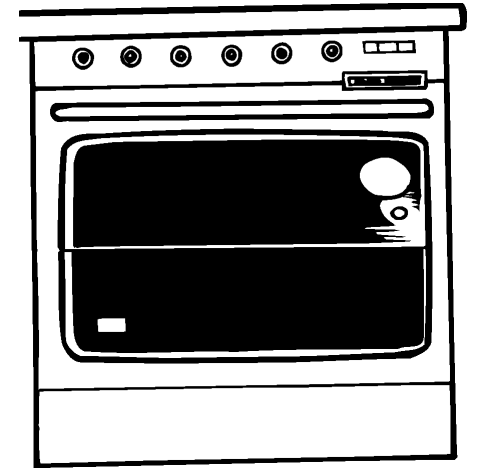
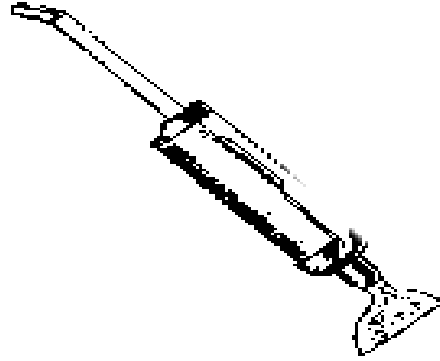
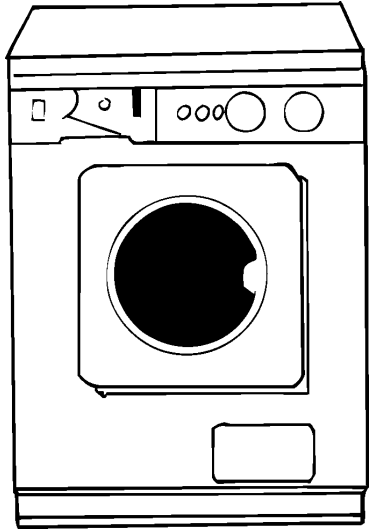

La lavatrice. L'aspirapolvere. Il forno.

"Il mio vocabolario": LA CASA
Far associare ogni parola all'immagine corrispondente.

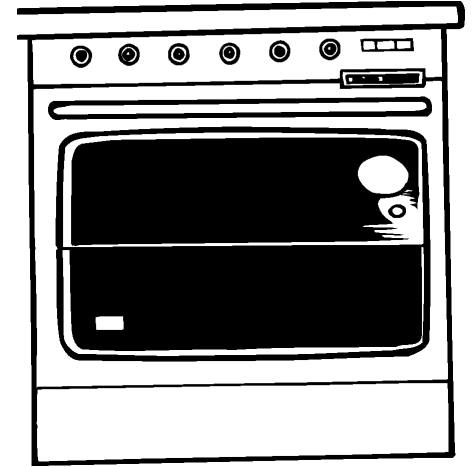
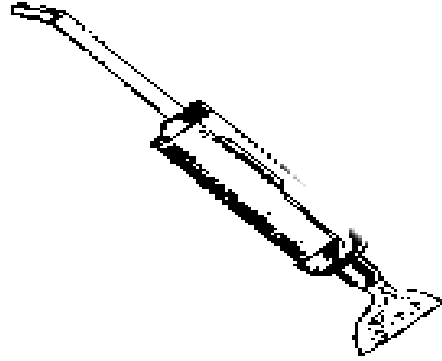
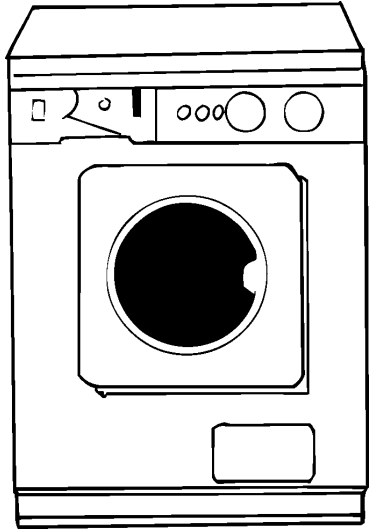

- La lavatrice
- l'aspirapolvere
- Il forno.

"Il mio vocabolario": LA CASA
Far associare ogni parola all'immagine corrispondente.

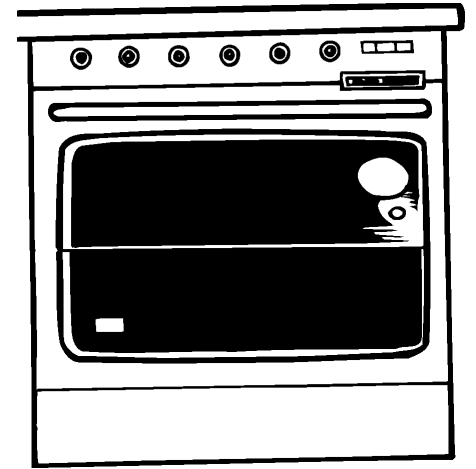
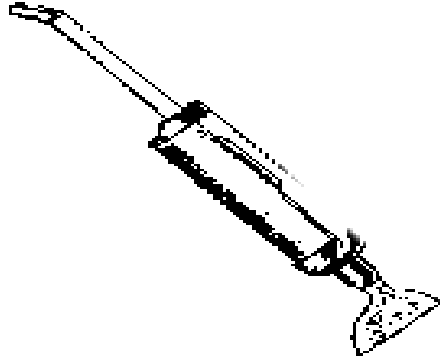
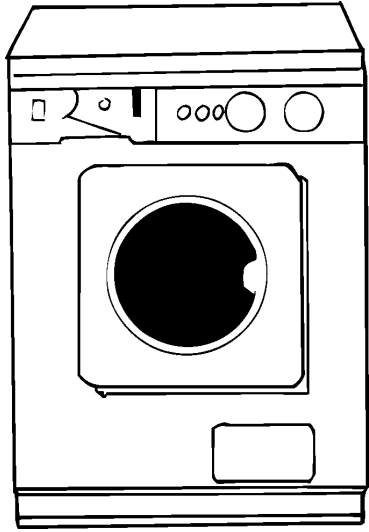

“Il mio vocabolario”: LA CASA
Come si chiama?

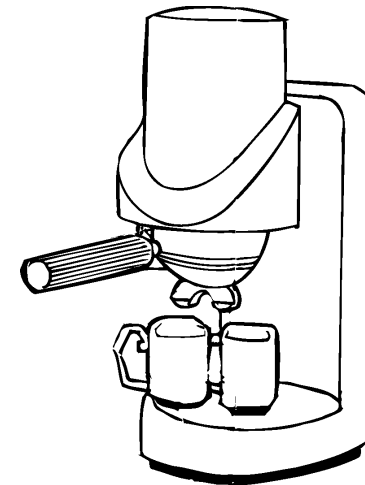
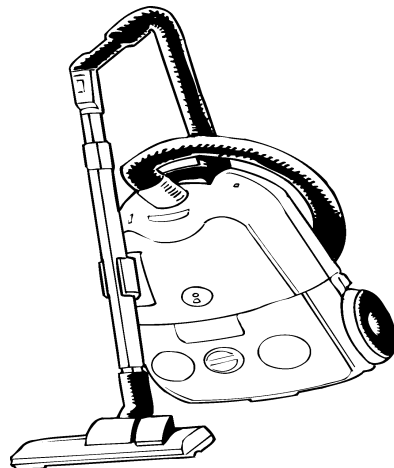
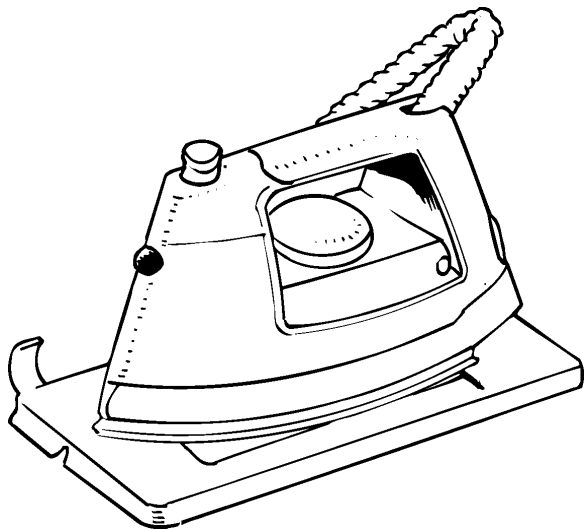

Il ferro da stiro.

L'aspirapolvere.

La macchina da caffè

"Il mio vocabolario": LA CASA
Far associare ogni parola all'immagine corrispondente.

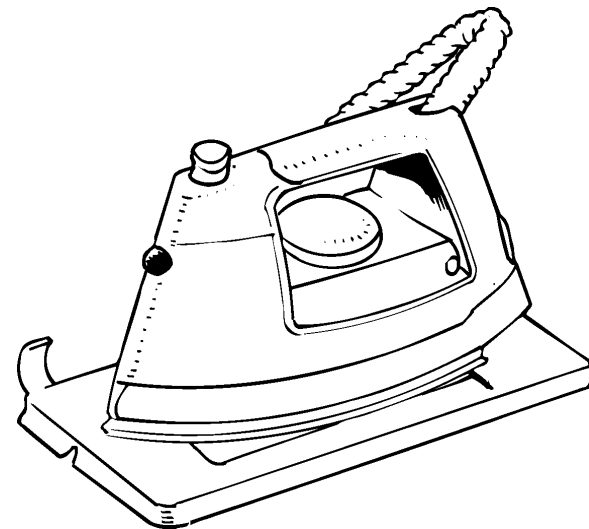
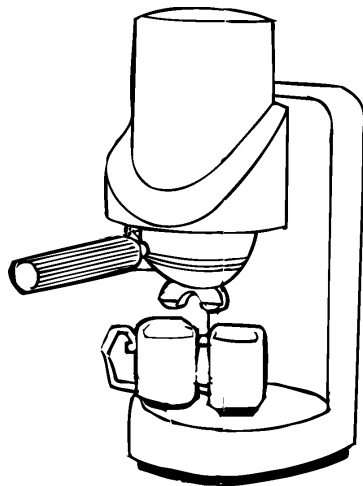
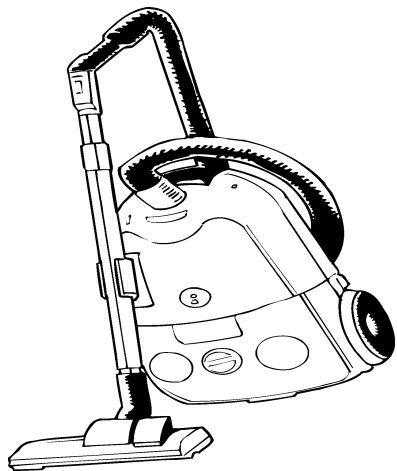

- Il ferro da stiro.
- L'aspirapolvere.
- la macchina da caffè.

"Il mio vocabolario": LA CASA
Far associare ogni parola all'immagine corrispondente.

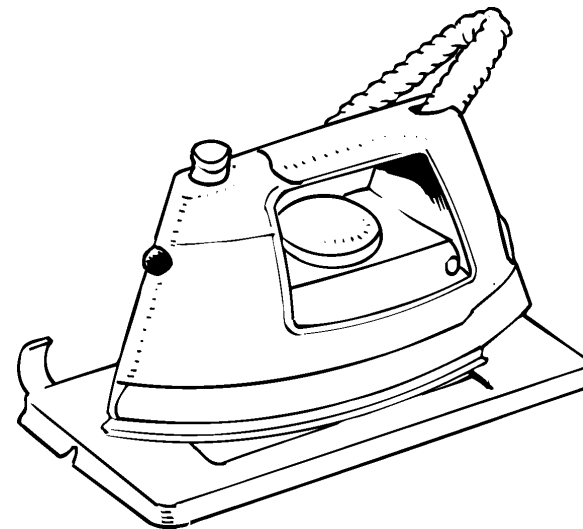
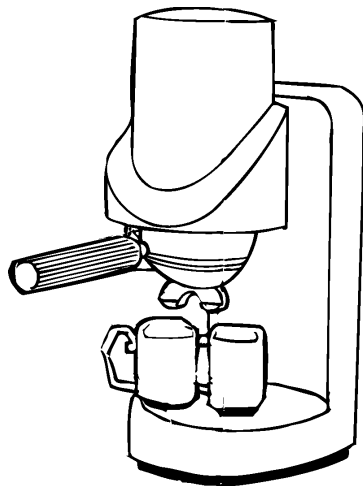
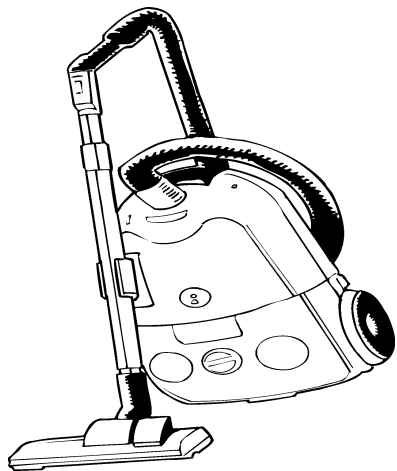

“Il mio vocabolario”: LA CASA
Come si chiama?

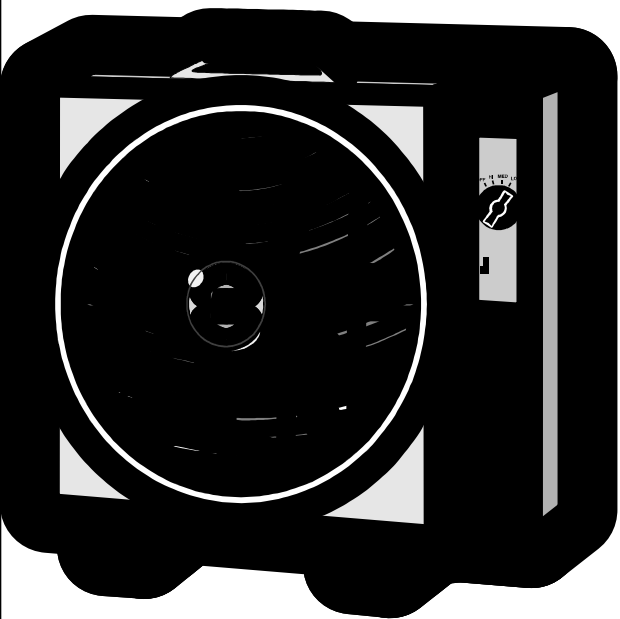

Il ventilatore

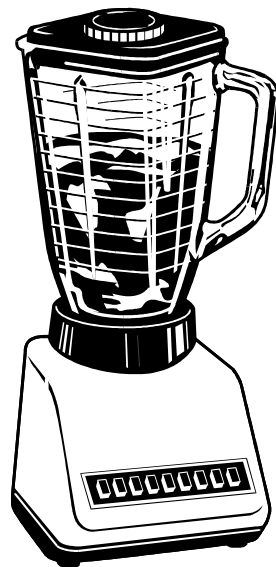

Il frullatore

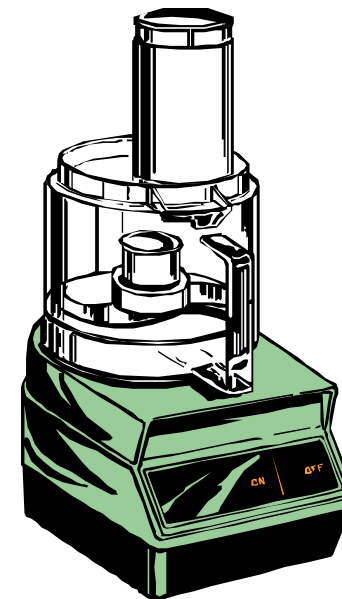

La centrifuga.

“Il mio vocabolario”: LA CASA
Far associare ogni parola all’immagine corrispondente.

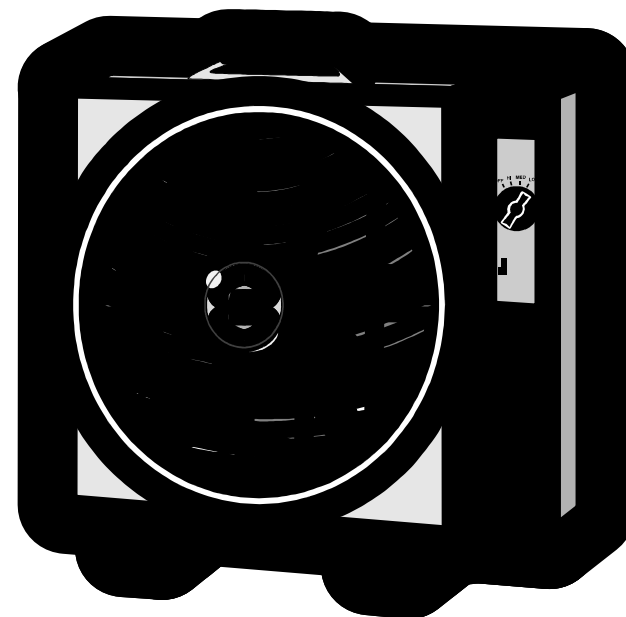
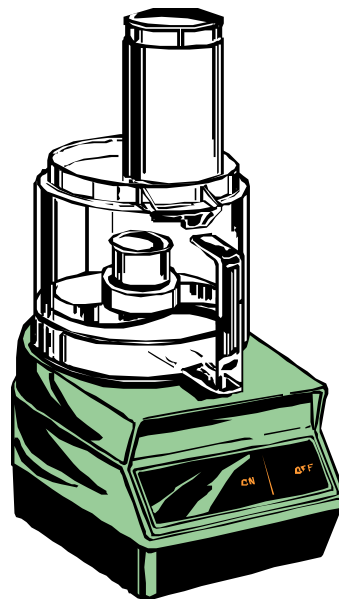

- Il ventilatore
 - Il frullatore
 - La centrifuga

“Il mio vocabolario”: LA CASA
Far associare ogni parola all’immagine corrispondente.

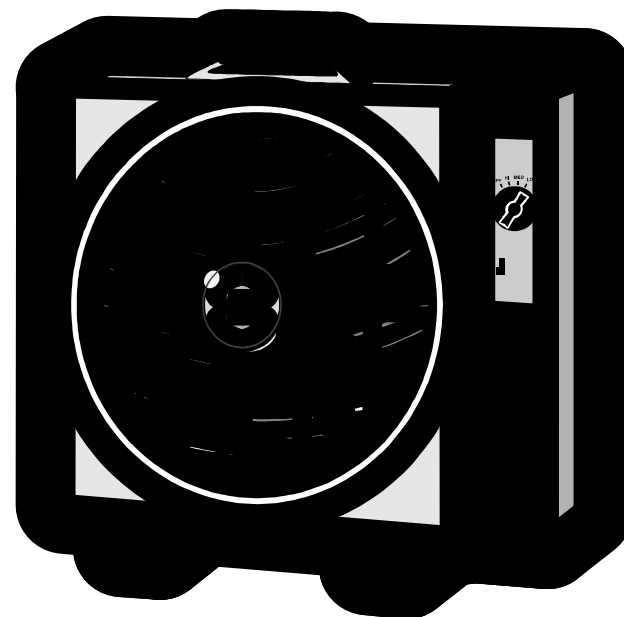
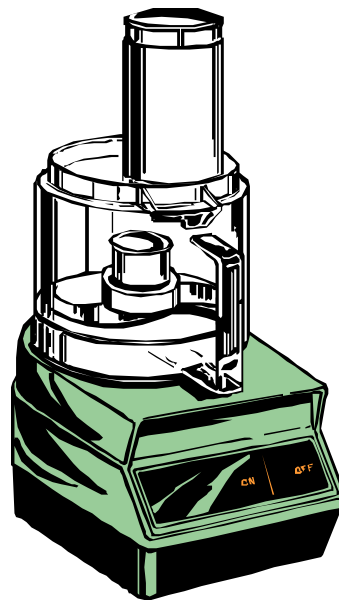

“Il mio vocabolario”: LA CASA
Come si chiama?